

# AUSTIN DINING BENCH ASSEMBLY INSTRUCTIONS

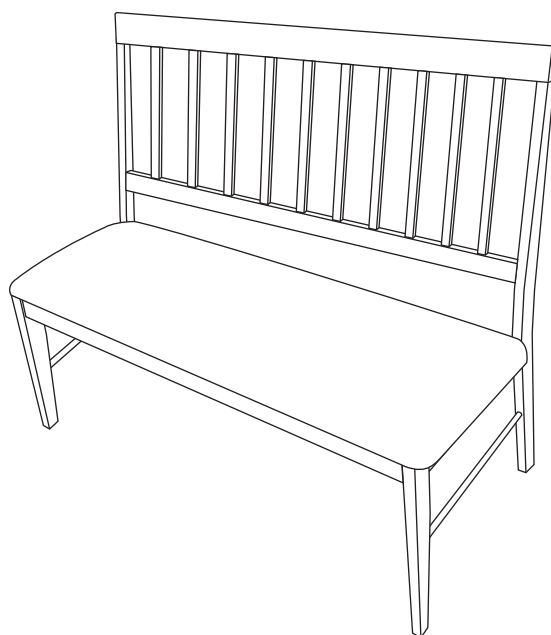

## IMPORTANT

FOR DOMESTIC USE ONLY

### PLEASE READ BEFORE YOU CONTINUE FURTHER

THE PRODUCT YOU HAVE PURCHASED WILL GIVE YOU MANY YEARS OF SERVICE IF YOU FOLLOW THE GUIDELINES FOR ITS SAFE ASSEMBLY AND PERIODIC MAINTENANCE AND CLEANING.

ASSEMBLE ON A SOFT CLEAN SURFACE.

DO NOT USE ANY TOOLS OTHER THAN THOSE SHOWN.

ANY SPANNERS OR ALLEN KEYS REQUIRED ARE INCLUDED WITH THE FITTINGS KIT.

DO NOT FOR ANY REASON USE A POWER TOOL TO ASSEMBLE THIS PRODUCT. ITS USE WILL INVALIDATE ANY CLAIM YOU MAY HAVE AND COULD MAKE THIS PRODUCT UNSAFE.

DEPENDING ON THE AMOUNT OF USE THIS PRODUCT RECEIVES IT MAY BE NECESSARY TO TIGHTEN UP THE FIXINGS FROM TIME TO TIME.

THIS IS COMPLETELY NORMAL FOR ANY FLAT PACK FURNITURE.

**DO NOT OVERTIGHTEN FIXINGS.**

**FOR CLEANING, YOU MAY USE A DAMP CLOTH (NOT WET). DO NOT USE POLISH, DETERGENT OR CHEMICAL CLEANERS.**

THE SURFACE OF THIS ITEM IS NOT HEAT RESISTANT. ALWAYS USE A PLACE MAT UNDER HOT OR COLD ITEMS TO PREVENT MARKING.



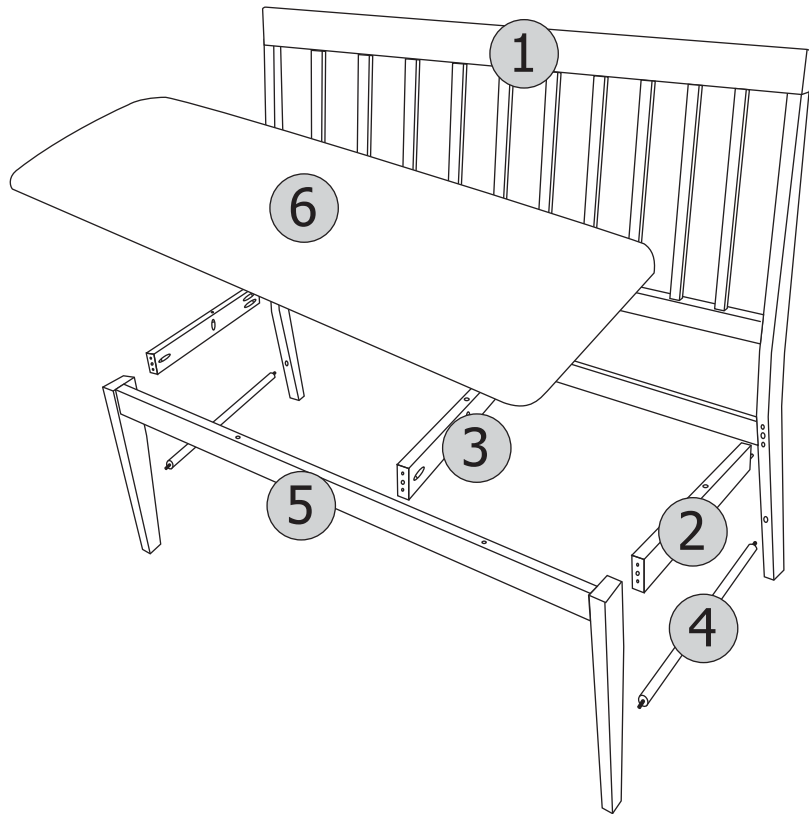



Please check that you have all the parts listed before you start assembling. If you do find that something is missing, do not continue assembly. Please contact your supplier immediately.



## **PART LIST**

<b>Part Number</b>	<b>Part Code</b>	<b>Part Description</b>	<b>Quantity</b>	<b>Carton</b>
1	S400-420-011-PU1-01B	Chair Back	1	1/1
2	S400-420-011-PU1-02B	Side Stretcher	2	1/1
3	S400-420-011-PU1-03B	Center Stretcher	1	1/1
4	S400-420-011-PU1-04B	Bottom Stretcher	2	1/1
5	S400-420-011-PU1-05B	Front Section	1	1/1
6	S400-420-011-PU1-06B	Cushion Seat	1	1/1

## **Hardware List**

<b>No.</b>	<b>Part Name</b>		<b>Qty</b>	<b>Carton</b>
A	M6 x 50mm JCBC		9	1
B	Spring Washer M6 x 13mm		9	1
C	Flat Washer M6 x 13mm		9	1
D	M4 x 32mm CSK Screw		9	1
E	Wood Dowel M8 x 30mm		9	1
F	Allen Key M4 x 107mm Ball Head		1	1

# STEP 1

## PARTS REQUIRED

2 - SIDE STRETCHER x2

3 - CENTRE STRETCHER x1

## HARDWARE REQUIRED

E  09

## TOOLS REQUIRED

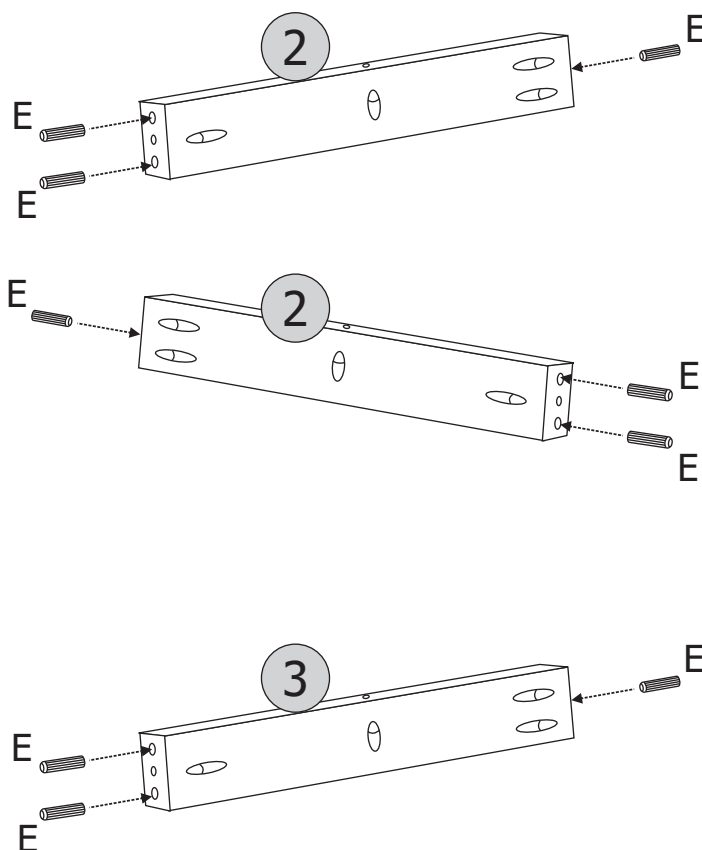
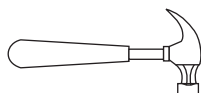

# STEP 2

## PARTS REQUIRED

1 - CHAIR BACK x1

2 - SIDE STRETCHER x2

3 - CENTRE STRETCHER x1

4 - BOTTOM STRETCHER x2

## HARDWARE REQUIRED

A  06

B  06

C  06

D  02

## TOOLS REQUIRED

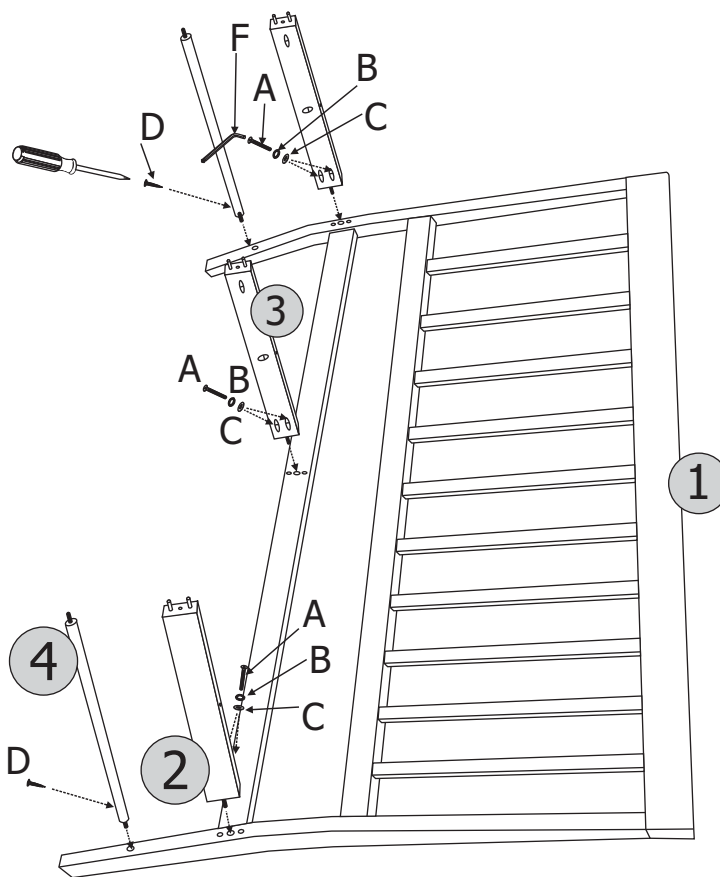

**Important**  
Please **do not** fully tighten  
the screws before **STEP 3 !!**





# STEP 3

## PARTS REQUIRED

5 - FRONT SECTION x1



## HARDWARE REQUIRED

- A  03
- B  03
- C  03
- D  02

## TOOLS REQUIRED

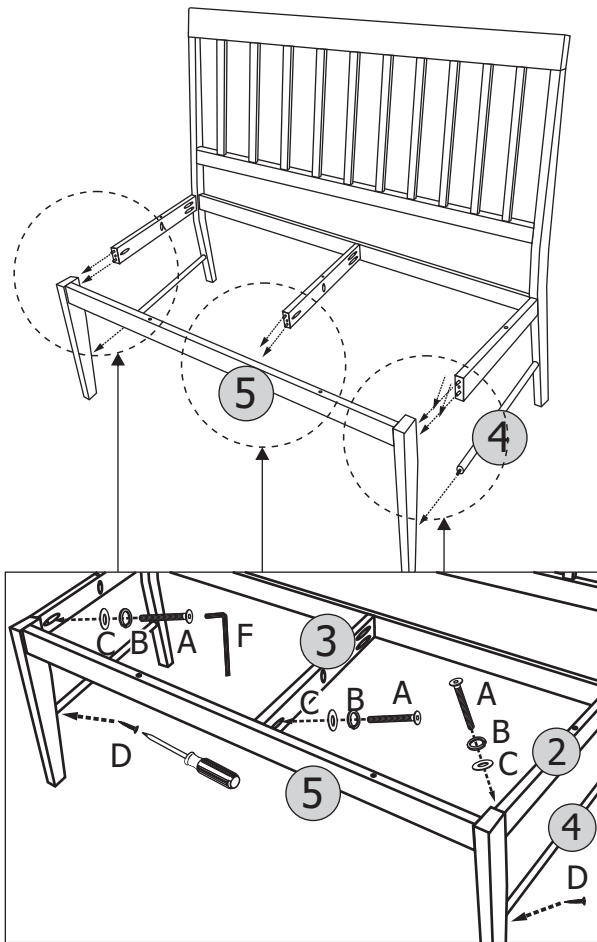
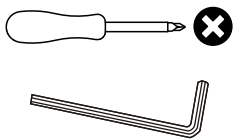

**Important**  
Please now fully tighten  
all bolts.

# STEP 4

## PARTS REQUIRED

6 - CUSHION SEAT x1

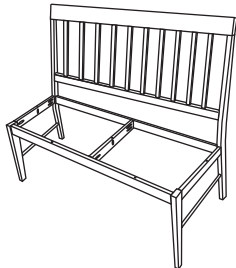

## HARDWARE REQUIRED

- D  05

## TOOLS REQUIRED

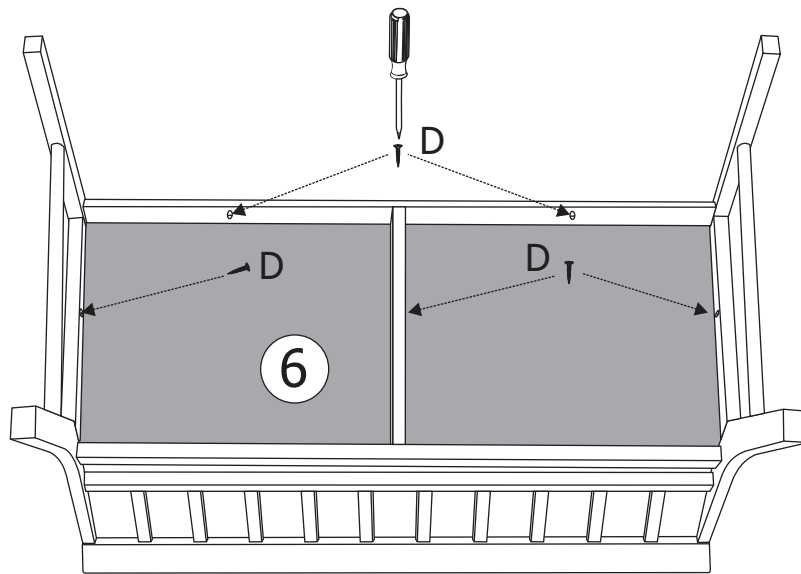
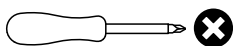

**Bottom View**

