

# BERLIN DINING TABLE ASSEMBLY INSTRUCTIONS

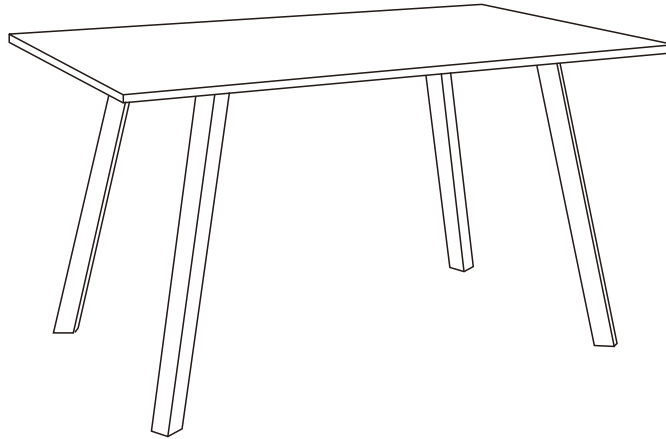

## **IMPORTANT FOR DOMESTIC USE ONLY PLEASE READ BEFORE YOU CONTINUE FURTHER**

THE PRODUCT YOU HAVE PURCHASED WILL GIVE YOU MANY YEARS OF SERVICE IF YOU FOLLOW THE GUIDELINES FOR ITS SAFE ASSEMBLY AND PERIODIC MAINTENANCE AND CLEANING .

ASSEMBLE ON A SOFT CLEAN SURFACE

DO NOT USE ANY TOOLS OTHER THAN THOSE SHOWN.

ANY SPANNERS OR ALLEN KEYS REQUIRED ARE INCLUDED WITH THE FITTINGS KIT.

DO NOT FOR ANY REASON USE A POWER TOOL TO ASSEMBLE THIS PRODUCT. ITS USE WILL INVALIDATE ANY CLAIM YOU MAY HAVE AND COULD MAKE THIS PRODUCT UNSAFE.

DEPENDING ON THE AMOUNT OF USE THIS PRODUCT RECEIVES IT MAY BE NECESSARY TO TIGHTEN UP THE FIXINGS FROM TIME TO TIME . THIS IS COMPLETELY NORMAL FOR ANY FLAT PACK FURNITURE.  
DO NOT OVERTIGHTEN FIXINGS.

FOR CLEANING, YOU MAY USE A DAMP CLOTH (NOT WET) DO NOT USE POLISH, DETERGENT OR CHEMICAL CLEANERS.

THIS PRODUCT MAY STAIN OR MARK IF ALLOWED TO COME INTO CONTACT WITH WET OR DAMP OBJECTS.

THE SURFACE OF THIS ITEM IS NOT HEAT RESISTANT. ALWAYS USE A PLACE MAT UNDER HOT OR COLD ITEMS TO PREVENT MARKING.

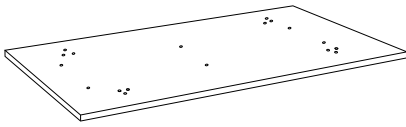

1



2

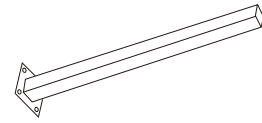





3

## **PARTS LIST**

<b>Part Number</b>	<b>Part Code</b>	<b>Part Description</b>	<b>Quantity</b>	<b>Carton</b>
1	S400-403-050-SF1-01	Table Top	1	1/2
2	S400-403-050-SF1-02	Support Bar	2	1/2
3	S400-403-050-SF1-03	Table Leg	4	2/2

## **HARDWARE LIST**

<b>REF</b>		<b>HARDWARE NAME</b>	<b>QTY</b>
A		<b>Bolts M8x16mm</b>	<b>16PCS</b>
B		<b>Bolts M6x25mm</b>	<b>6PC</b>
C		<b>Allen Key</b>	<b>16PC</b>
D		<b>Metal Washer</b>	<b>1PC</b>

**PLEASE CHECK THAT YOU HAVE ALL THE PARTS LISTED BEFORE YOU START ASSEMBLING. IF YOU DO FIND THAT SOMETHING IS MISSING, DO NOT CONTINUE ASSEMBLY. PLEASE CONTACT YOUR SUPPLIER IMMEDIATELY.**

# STEP 1

## PARTS REQUIRED

1 - TABLE TOP	x1
2 - SUPPORT BAR	x2

## HARDWARE REQUIRED

B		06
---	---	----

## TOOLS REQUIRED



M6x25mm

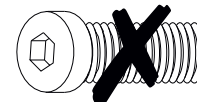

M8x16mm

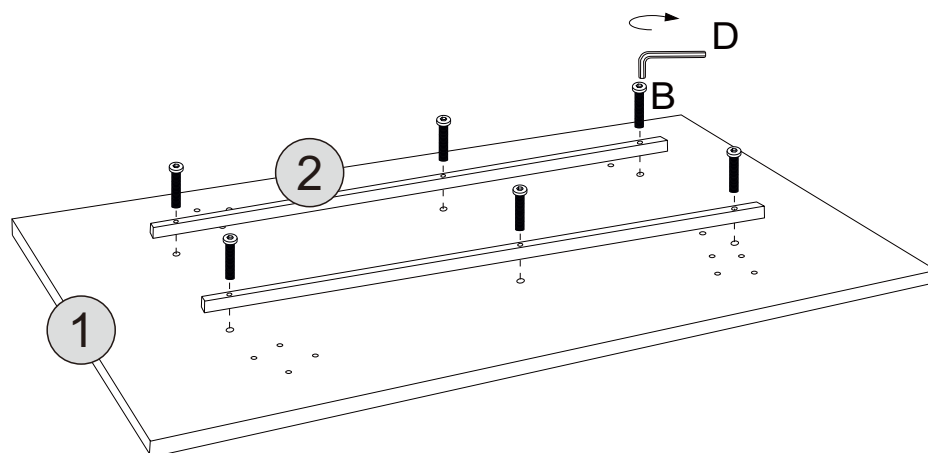

# STEP 2

## PARTS REQUIRED

1 - TABLE TOP	x1
3 - TABLE LEG	x4

## HARDWARE REQUIRED

A		16
---	---	----

C		16
---	---	----

## TOOLS REQUIRED

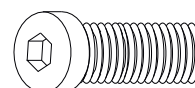

M8x16mm

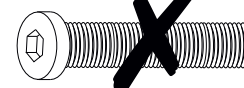

M6x25mm

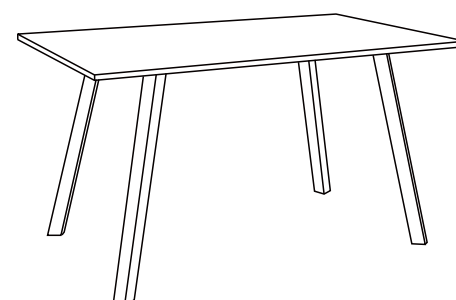
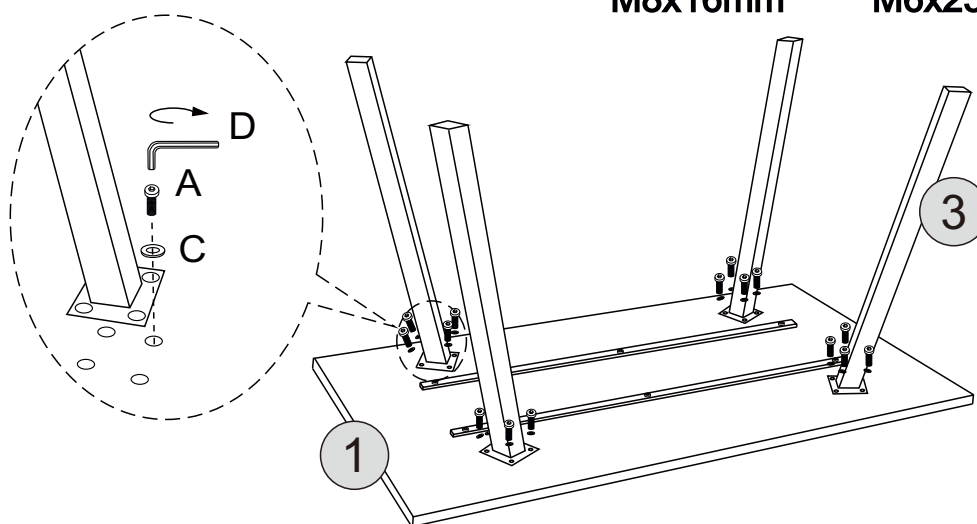

# LUKAS DINING CHAIR ASSEMBLY INSTRUCTIONS

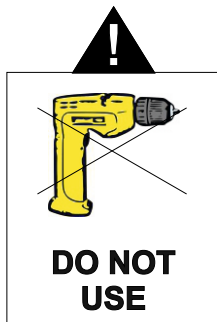

**MAX CHAIR  
WEIGHT**

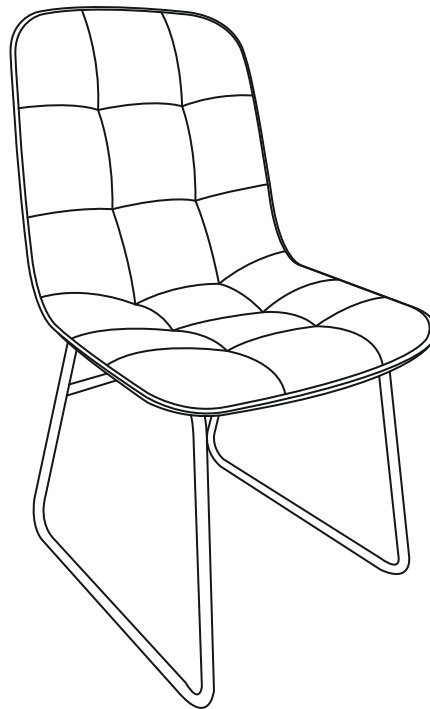

## **IMPORTANT FOR DOMESTIC USE ONLY PLEASE READ BEFORE YOU CONTINUE FURTHER**

THE PRODUCT YOU HAVE PURCHASED WILL GIVE YOU MANY YEARS OF SERVICE IF YOU FOLLOW THE GUIDELINES FOR ITS SAFE ASSEMBLY AND PERIODIC MAINTENANCE AND CLEANING .

ASSEMBLE ON A SOFT CLEAN SURFACE

DO NOT USE ANY TOOLS OTHER THAN THOSE SHOWN.

ANY SPANNERS OR ALLEN KEYS REQUIRED ARE INCLUDED WITH THE FITTINGS KIT.

DO NOT FOR ANY REASON USE A POWER TOOL TO ASSEMBLE THIS PRODUCT. ITS USE WILL INVALIDATE ANY CLAIM YOU MAY HAVE AND COULD MAKE THIS PRODUCT UNSAFE.

DEPENDING ON THE AMOUNT OF USE THIS PRODUCT RECEIVES IT MAY BE NECESSARY TO TIGHTEN UP THE FIXINGS FROM TIME TO TIME . THIS IS COMPLETELY NORMAL FOR ANY FLAT PACK FURNITURE.

DO NOT OVERTIGHTEN FIXINGS.

FOR CLEANING, YOU MAY USE A DAMP CLOTH (NOT WET) DO NOT USE POLISH, DETERGENT OR CHEMICAL CLEANERS.

THIS PRODUCT MAY STAIN OR MARK IF ALLOWED TO COME INTO CONTACT WITH WET OR DAMP OBJECTS.

THE SURFACE OF THIS ITEM IS NOT HEAT RESISTANT. ALWAYS USE A PLACE MAT UNDER HOT OR COLD ITEMS TO PREVENT MARKING.

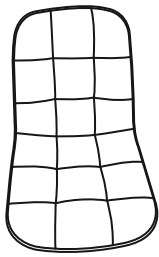

1



2



3



4

## PARTS LIST

Part Number	Part Description	Quantity	Carton
1	Seat Pad	1	1/1
2	Chair Leg (L)	1	1/1
3	Chair Leg (R)	1	1/1
4	Chair Support Bar	1	1/1

## HARDWARE LIST

REF		HARDWARE NAME	QTY
A		Bolts M6x18mm	8PCS
B		Bolts M6x13mm	2PCS
C		Metal Washer	8PCS
D		Metal Washer	2PCS
E		Allen Key	1PC

PLEASE CHECK THAT YOU HAVE ALL THE PARTS LISTED BEFORE YOU START ASSEMBLING. IF YOU DO FIND THAT SOMETHING IS MISSING, DO NOT CONTINUE ASSEMBLY. PLEASE CONTACT YOUR SUPPLIER IMMEDIATELY.

# STEP 1

**PARTS REQUIRED**

2 - CHAIR LEG (A) x1

3 - CHAIR LEG (B) x1

4 - CHAIR SUPPORT BAR x1

**HARDWARE REQUIRED**

B  02

D  02

**TOOLS REQUIRED**

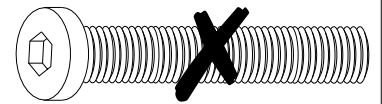

**M6x18mm**

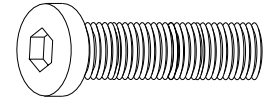

**M6x13mm**

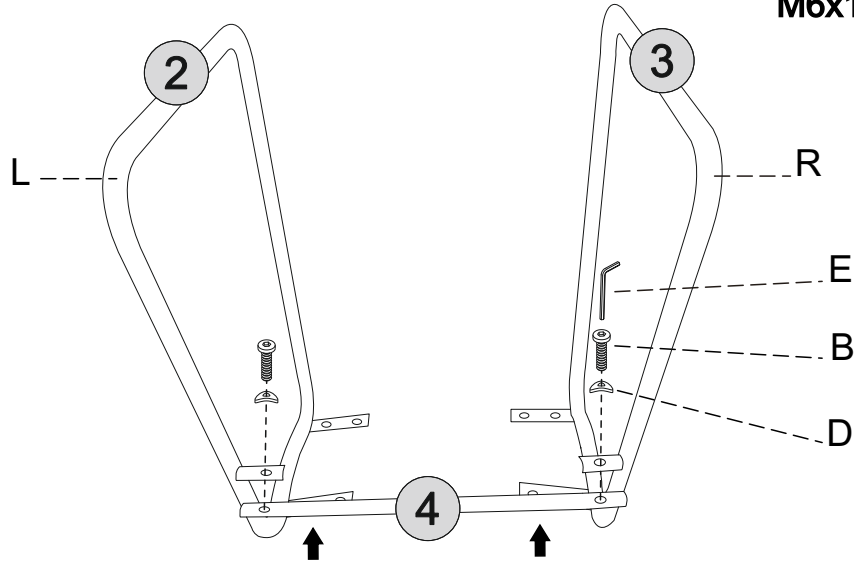

# STEP 2

**PARTS REQUIRED**

1 - SEAT PAD x1

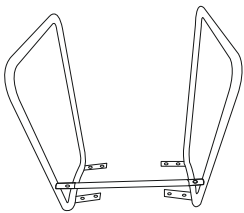

**HARDWARE REQUIRED**

A  08

C  08

**TOOLS REQUIRED**

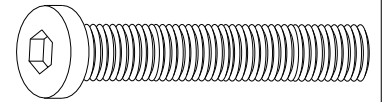
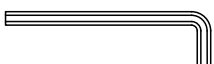

**M6x18mm**

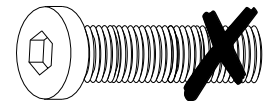

**M6x13mm**

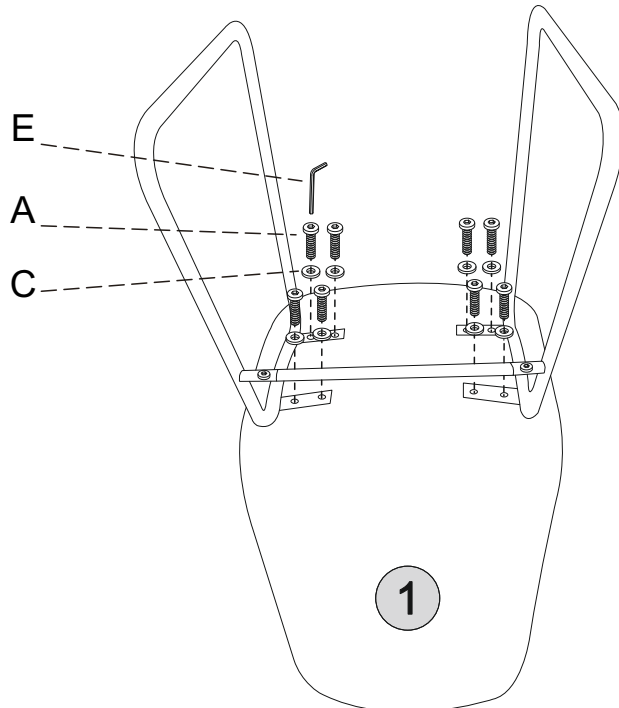

**100KG**  
MAX CHAIR  
WEIGHT

