

LEON 1 DOOR 2 SHELF CABINET ASSEMBLY INSTRUCTIONS

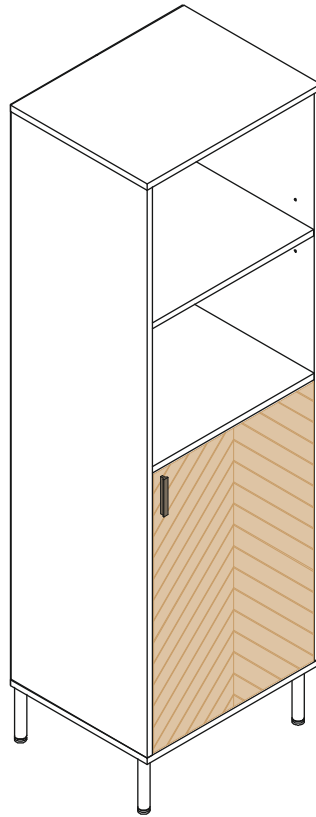

**FOR DOMESTIC USE ONLY
IMPORTANT**

PLEASE READ BEFORE YOU CONTINUE FURTHER

THE PRODUCT YOU HAVE PURCHASED WILL GIVE YOU MANY YEARS OF SERVICE IF YOU FOLLOW THE GUIDELINES FOR ITS SAFE ASSEMBLY AND PERIODIC MAINTENANCE AND CLEANING.

ASSEMBLE ON A SOFT CLEAN SURFACE.

DO NOT USE ANY TOOLS OTHER THAN THOSE SHOWN.

ANY SPANNERS OR ALLEN KEYS REQUIRED ARE INCLUDED WITH THE FITTING KIT.

DO NOT FOR ANY REASON USE A POWER TOOL TO ASSEMBLE THIS PRODUCT. ITS USE WILL INVALIDATE ANY CLAIM YOU MAY HAVE AND COULD MAKE THIS PRODUCT UNSAFE.

DEPENDING ON THE AMOUNT OF USE THIS PRODUCT RECEIVES, IT MAY BE NECESSARY TO TIGHTEN UP THE FIXINGS FROM TIME TO TIME. THIS IS COMPLETELY NORMAL FOR ANY FLAT PACK FURNITURE. DO NOT OVERTIGHTEN FIXINGS.

FOR CLEANING, YOU MAY USE A DAMP CLOTH (NOT WET). DO NOT USE POLISH, DETERGENT OR CHEMICAL CLEANERS.



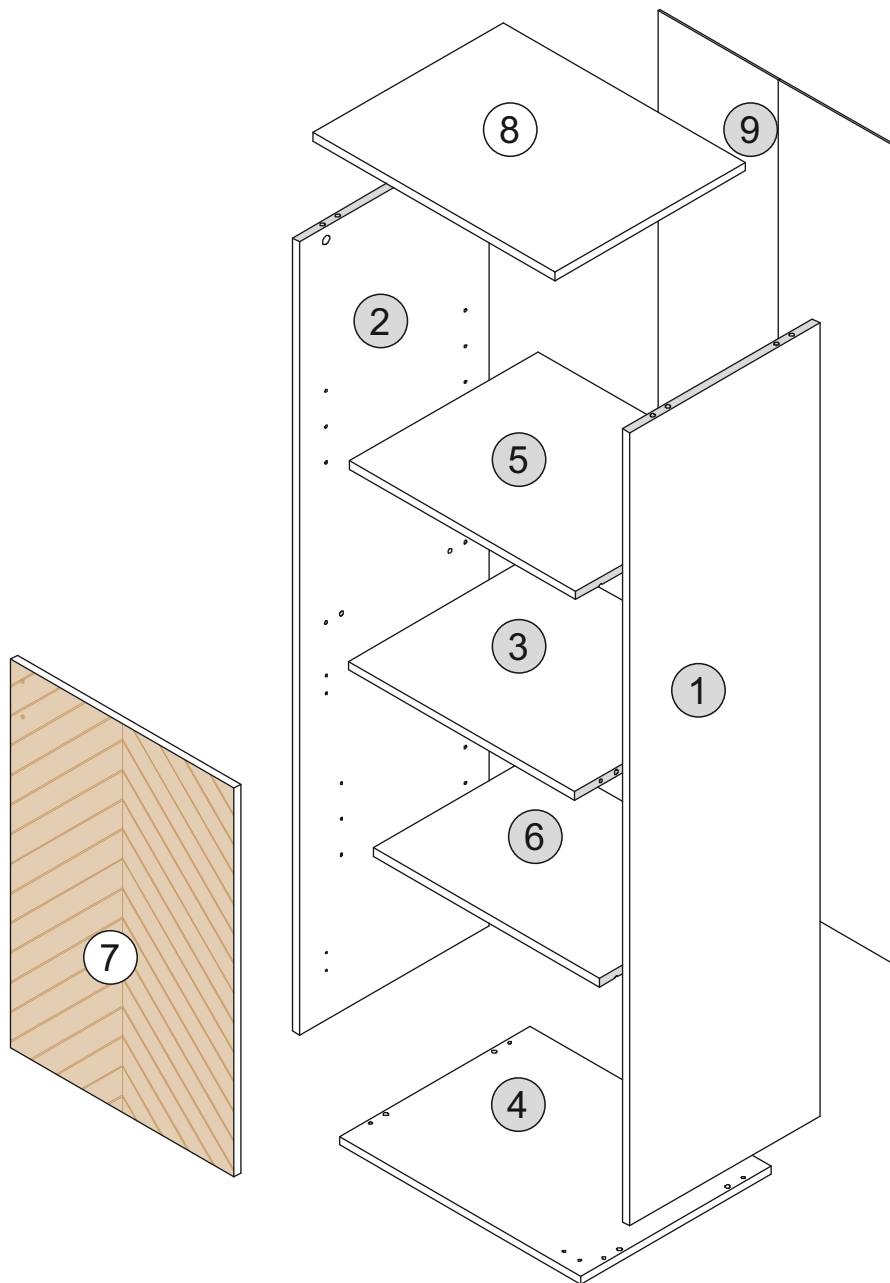











THIS SURFACE OF THIS ITEM IS NOT HEAT RESISTANT. ALWAYS USE A PLACE MAT UNDER HOT OR COLD ITEMS TO PREVENT MARKING.



PART LIST

Part Number	Part Code	Part Description	Quantity	Carton
1	S300-320-036-ZF1-01	Right Side Panel	1	1/1
2	S300-320-036-ZF1-01	Left Side Panel	1	1/1
3	S300-320-036-ZF1-01	Shelf Panel	1	1/1
4	S300-320-036-ZF1-01	Bottom Panel	1	1/1
5	S300-320-036-ZF1-01	Large Shelf Panel	1	1/1
6	S300-320-036-ZF1-01	Small Shelf Panel	1	1/1
7	S300-320-036-ZF1-01	Door	1	1/1
8	S300-320-036-ZF1-01	Top Panel	1	1/1
9	S300-320-036-ZF1-01	Back Panel	1	1/1

HARDWARE LIST

No	Part Name		Qty	Carton
A	M8x30mm Wooden Dowel		x12	1
B	Minifix Cam Bolt (8032t)		x8	1
C	Minifix Cam Nut (1512)		x8	1
D	M3.5x16mm Screw		x24	1
E	M4x45mm Screw		x4	1
F	Iron Leg (150mm) - Black		x4	1
G	20mm Handle Screw		x2	1
H	Handle (64mm)		x1	1
I	End Hinges (M11)		x4	1
J	Nail		x42	1
K	Screw Cover (Sticker 22mm)		x8	1
L	Shelf Support		x8	1
M	Door Stopper - Black		x1	1
N	Wall Fixing (4x20mm=1pc)		x1	1

TIPS FOR FITTINGS CAM-LOCKS

WHEN FITTING CAM NUT. ENSURE STARTING POSITION IS CORRECT BEFORE YOU INSERT CONNECTING CAM BOLT TURN CLOCKWISE UNTIL SECURE



↑

CORRECT



↓

WRONG

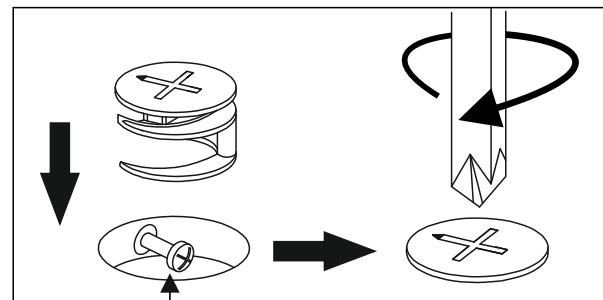

Cam bolt head needs to be in centre

CAMBOLT

Tighten until shoulder in flush with panel. Do not overtighten or undertighten (see example below)

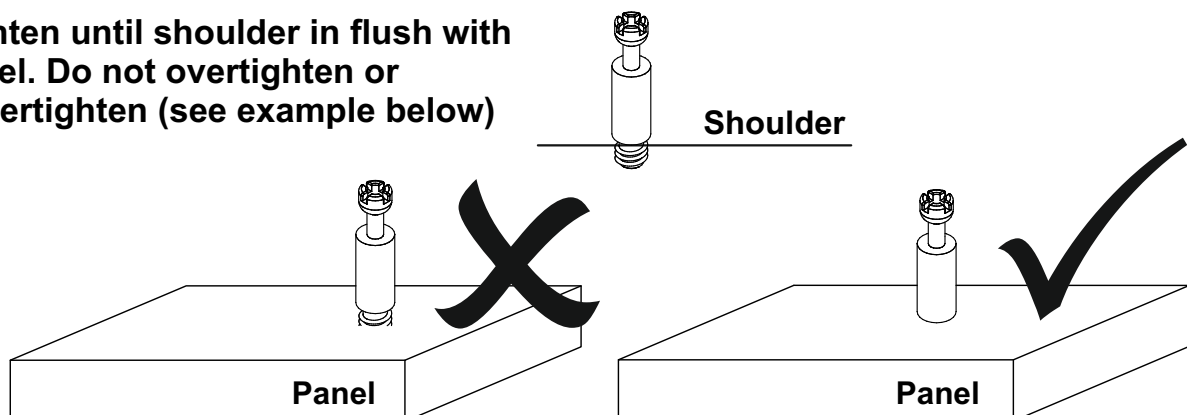

STEP 1

PARTS REQUIRED

1 - RIGHT SIDE PANEL x1

2 - LEFT SIDE PANEL x1

HARDWARE REQUIRED

A  08

B  04

C  04

L  08

TOOLS REQUIRED

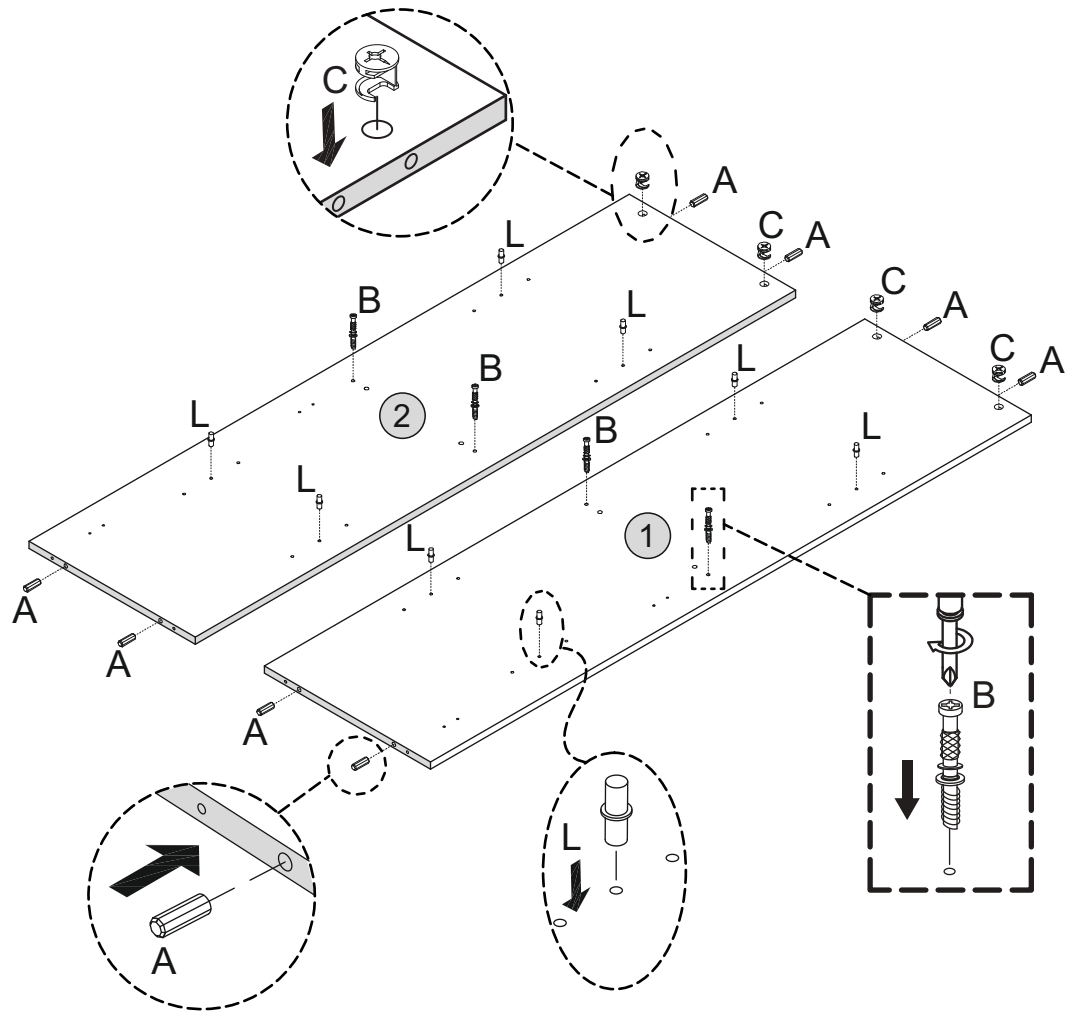
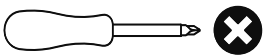
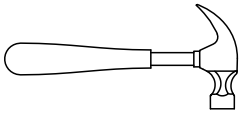

STEP 2

PARTS REQUIRED

3 - CENTRE SHELF PANEL x1

8 - TOP PANEL x1

HARDWARE REQUIRED

A  04

B  04

C  04

E  01

TOOLS REQUIRED

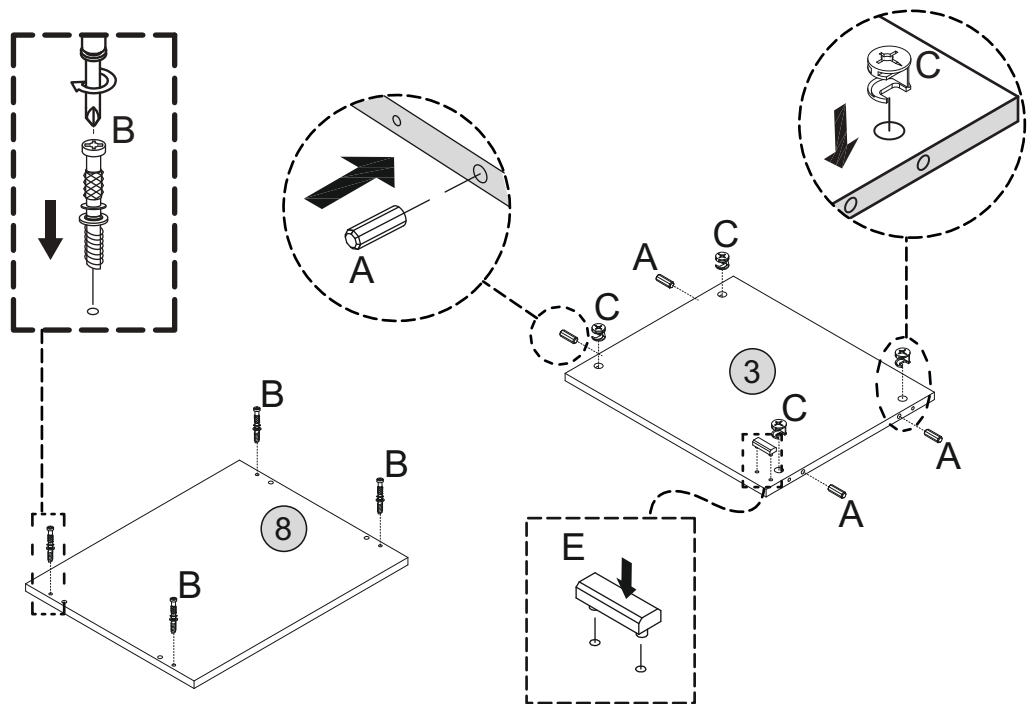
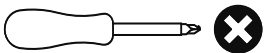
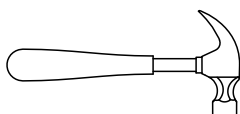

STEP 3

PARTS REQUIRED

7 - DOOR x1

HARDWARE REQUIRED

D  04
3.5x16mm

I  02

TOOLS REQUIRED

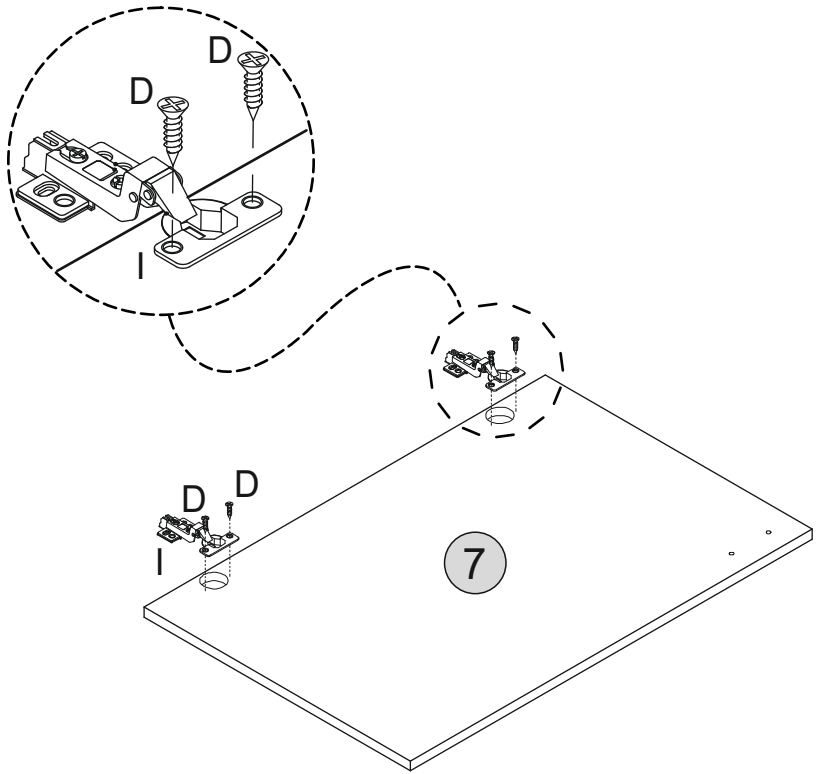
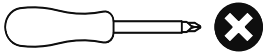

STEP 4

PARTS REQUIRED

2 - LEFT SIDE PANEL x1

3 - CENTRE SHELF PANEL x1

HARDWARE REQUIRED

K  02

TOOLS REQUIRED

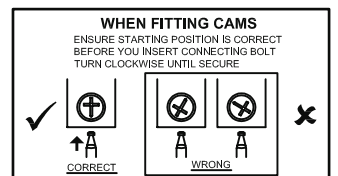
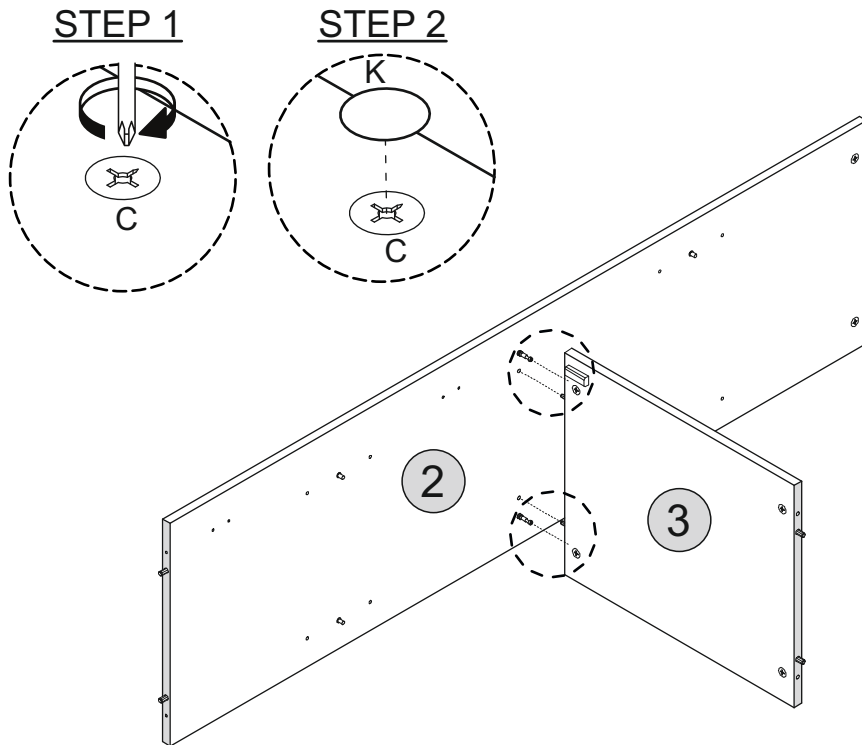
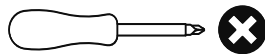

STEP 5

PARTS REQUIRED

1 - RIGHT SIDE PANEL x1

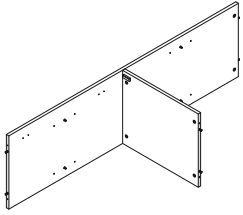

HARDWARE REQUIRED

K  02

TOOLS REQUIRED

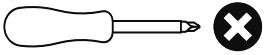

STEP 1

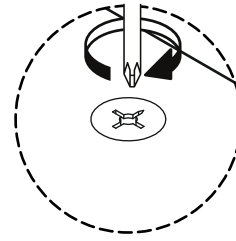

STEP 2

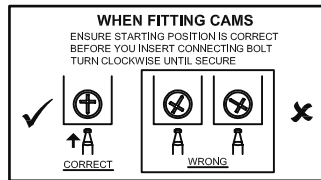
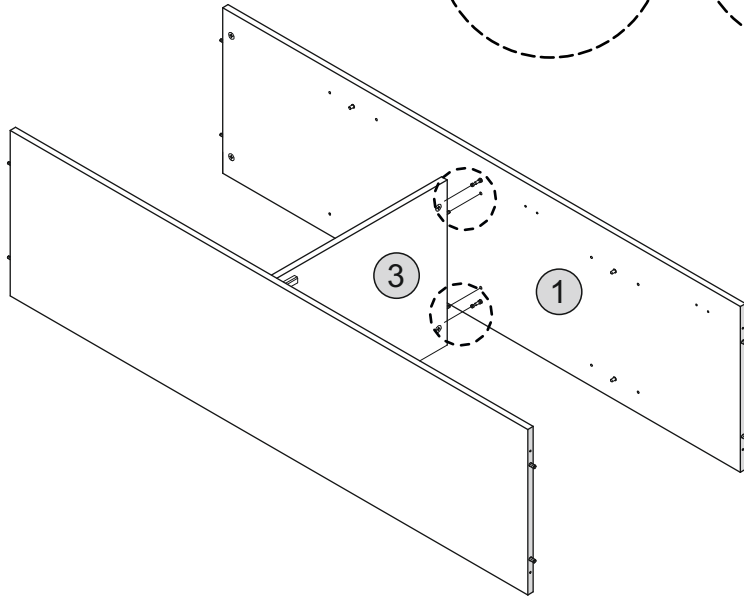
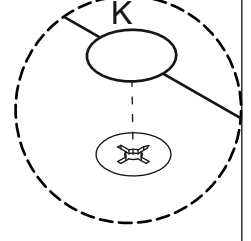

STEP 6

PARTS REQUIRED

8 - TOP PANEL x1

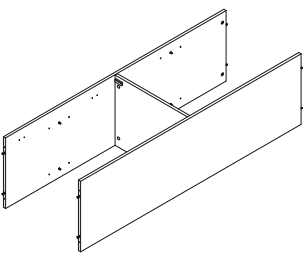

HARDWARE REQUIRED

K  04

TOOLS REQUIRED

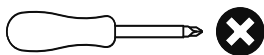

STEP 1

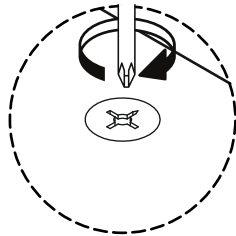

STEP 2

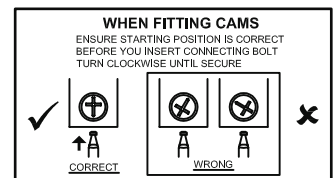
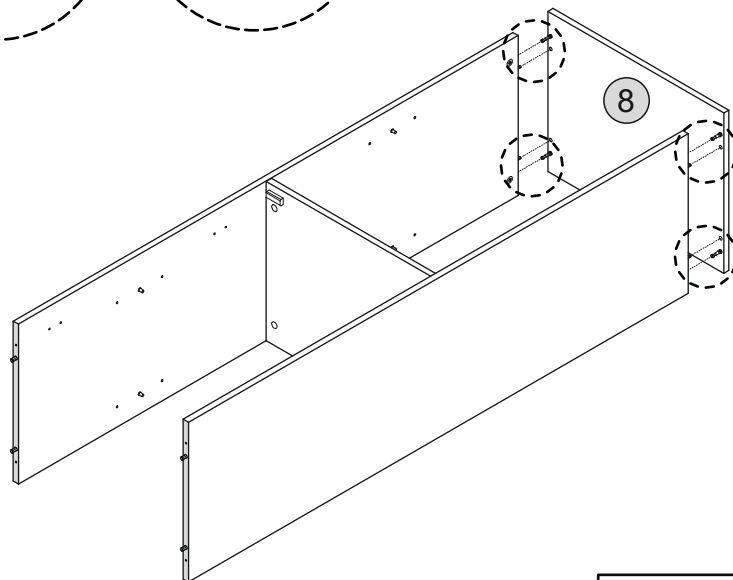
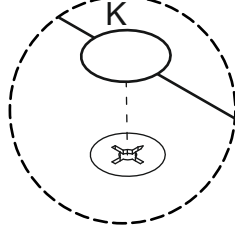

STEP 7

PARTS REQUIRED

4 - BOTTOM PANEL x1

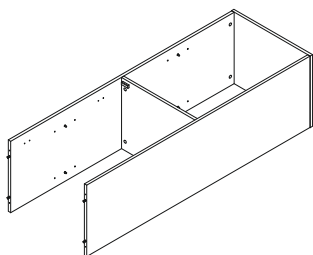

HARDWARE REQUIRED

E  04
4x45mm

TOOLS REQUIRED

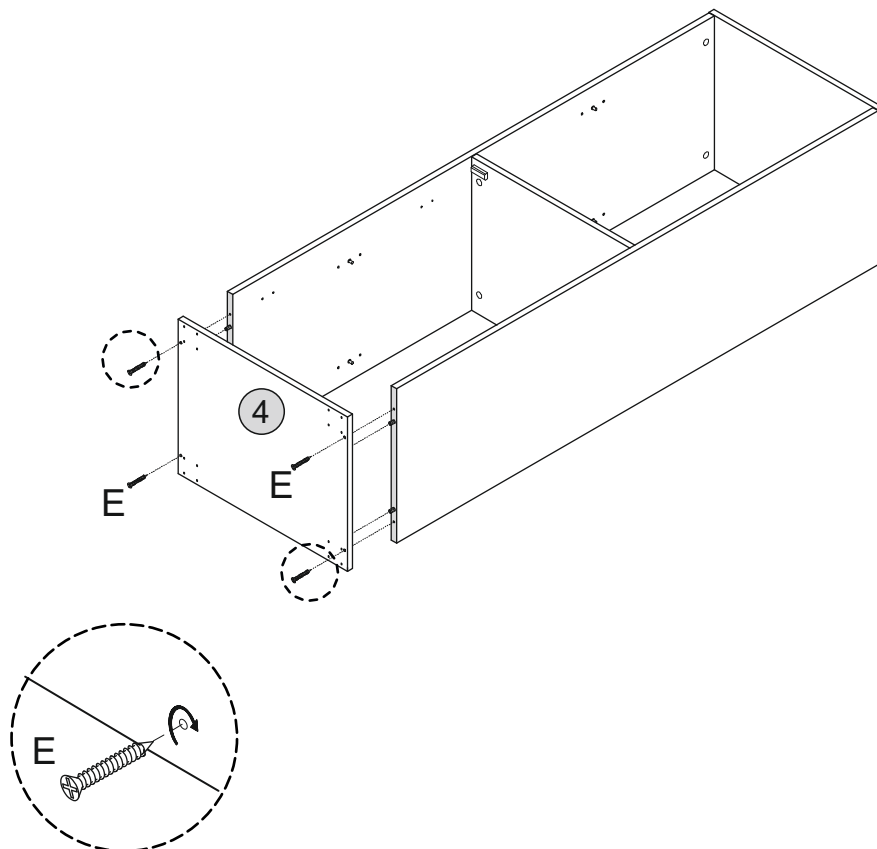
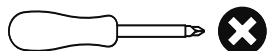

STEP 8

PARTS REQUIRED

9 - BACK PANEL x1

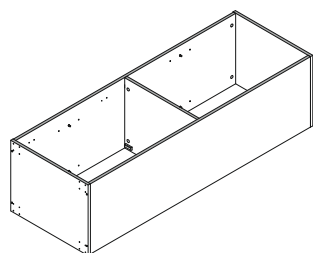

HARDWARE REQUIRED

D  16
3.5x16mm

F  04

J  42

TOOLS REQUIRED

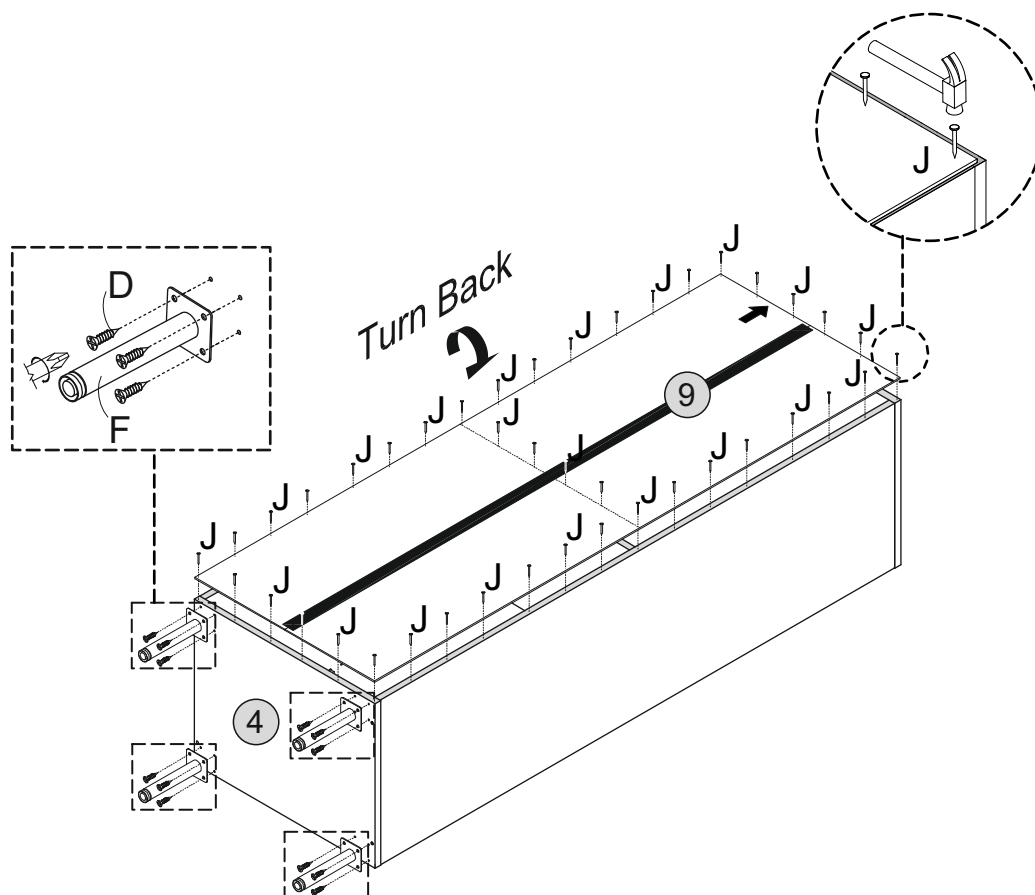
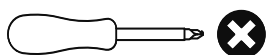

STEP 9

PARTS REQUIRED

5 - LARGE SHELF PANEL x1

6 - SMALL SHELF PANEL x1

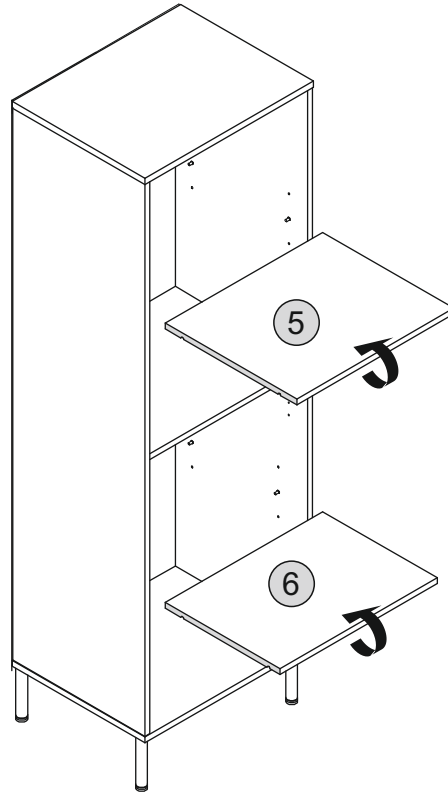
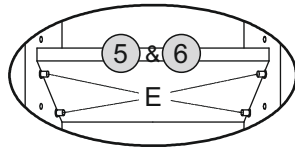
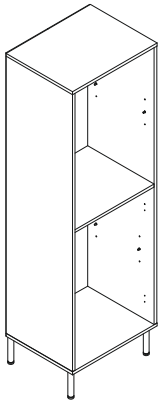

HARDWARE REQUIRED

TOOLS REQUIRED

STEP 10

PARTS REQUIRED

7 - DOOR x1

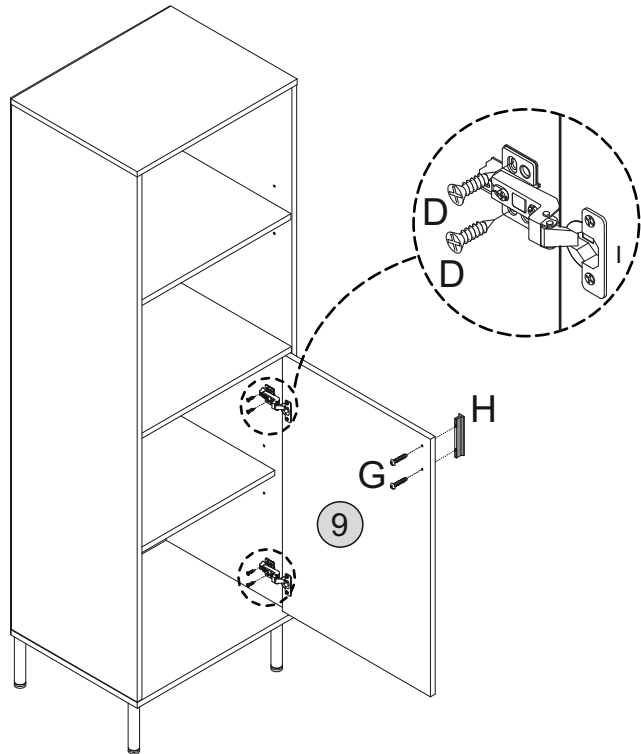
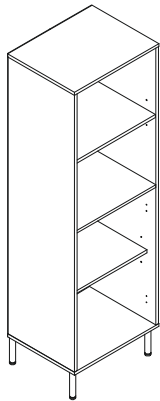

HARDWARE REQUIRED

D  04
3.5x16mm

G  02

H  01

TOOLS REQUIRED

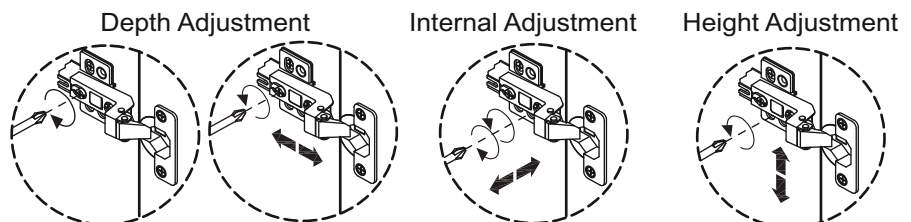
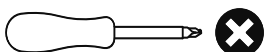

STEP 11

PARTS REQUIRED

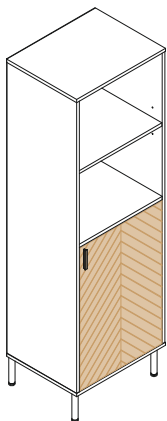

HARDWARE REQUIRED

N  01

TOOLS REQUIRED

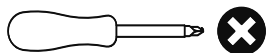

WARNING

Serious or fatal injuries can occur from furniture tipping over. To prevent the furniture from tipping over we recommend that it is permanently fixed to the wall.

Wall fixings are not supplied with this product as different wall materials require different types of fixing devices. Please make sure you use fixings suitable for the walls in your home.

