

BRANDON BUNK BED ASSEMBLY INSTRUCTION

IMPORTANT: READ CAREFULLY – RETAIN FOR FUTURE REFERENCE

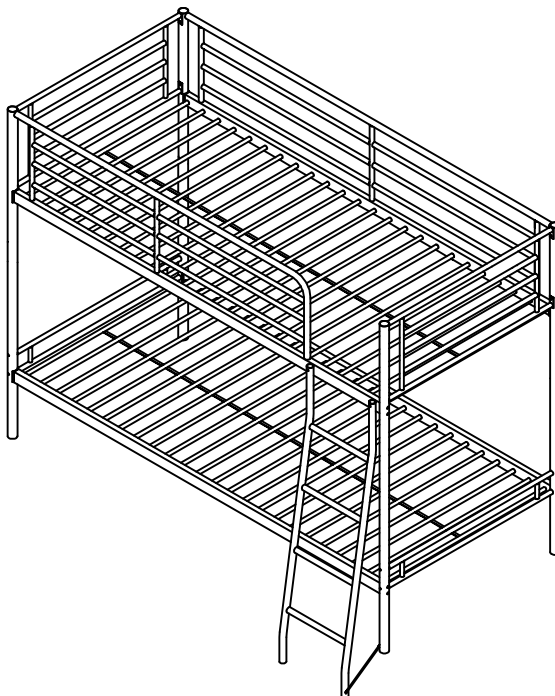





FOR DOMESTIC USE ONLY

IMPORTANT NOTICE

SAFETY WARNING

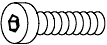
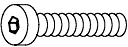
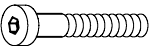
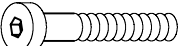
- The upper bed of the bunk is not suitable for children under six years of age due to the risk of injury from falls.
- Strangulation Hazard-never attach or hang items to any part of the bunk bed: for example, hooks, belts, cords and harness ect.
- The recommended mattress size for this bunk bed is 6' 3" x 3' x 6" (1900mm x 915mm x 150mm).
- The maximum mattress thickness is 6".
- The maximum mattress height is clearly marked on the bunk and **MUST NOT BE EXCEEDED**.
- Children can become trapped between the bed and the wall. To avoid risk of serious injury the distance between the top safety barrier and the wall shall not exceed 75mm or shall be more than 230mm.
- The bunk bed should not be used if any structural part is broken or missing.
- Assemble on a soft clean surface.
- Do not use any tools other than those shown.
- Any spanners or Allen keys required are included with the fittings kit.
- Do not for any reason use a power tool to assemble this product. Its use will invalidate any claim you may have and could make this product unsafe.
- Assembly fixings should always be tightened properly and care should be taken that no fittings are loose.
- Depending on the amount of use this product receives it may be necessary to tighten up the fixings from time to time. This is completely normal for any flat pack furniture. **DO NOT OVERTIGHTEN FIXINGS.**
- Two persons required to assemble this product.
- For cleaning you may use a damp cloth(not wet)
- This bunk is manufactured to conform to BS EN 747-2012

PLEASE CHECK THAT YOU HAVE ALL THE PARTS LISTED BEFORE YOU START ASSEMBLY. IF YOU DO FIND THAT SOMETHING IS MISSING, PLEASE CONTACT YOUR SUPPLIER IMMEDIATELY

REF		HARDWARE LIST	QTY
a		BOLT M6X15mm	10PCS
b		BOLT M6X35mm	2PCS
c		BOLT M6X45mm	11PCS
d		BOLT M6X55mm	6PCS
e		BOLT M8X45mm	16PCS
f		NUT	2PCS
g		WASHER M6	11PCS
h		WASHER M8	16PCS
i		ALLEN KEY M4	2PCS

CARE & MAINTENANCE

- 1) No power tools shall be used for assembly of the bed . Use only allen keys provided for assembly.
- 2) Periodically check and ensure all bolts are fully tightened



Method of Cleaning

- 1) Use damp cloth for normal cleaning.
- 2) For bright parts, use a clean dry duster only.

USE OF POWER TOOLS TO ASSEMBLE THIS PRODUCT WILL INVALIDATE ANY CLAIM AND MAY DAMAGE THIS PRODUCT, MAKING IT UNSAFE.

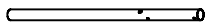
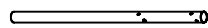
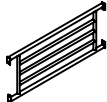
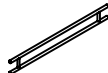
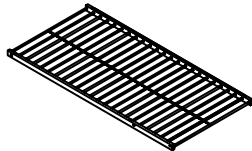
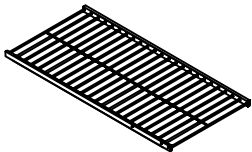
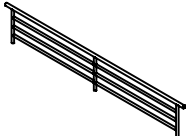
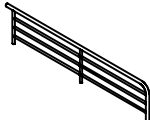
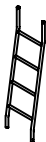

PLEASE CHECK THAT YOU HAVE ALL THE PARTS LISTED BEFORE YOU START ASSEMBLY. IF YOU DO FIND THAT SOMETHING IS MISSING, PLEASE CONTACT YOUR SUPPLIER IMMEDIATELY

REF		PART LIST	QTY
①		POSTS(WITH SAFETY RAIL HOLES)	3PCS
②		FRONT RIGHT POSTS	1PC
③		UPPER HEADBOARD AND FOOTBOARD	2PCS
④		LOWER SUPPORT BAR	2PCS
⑤		UPPER BASE	1PC
⑥		LOWER BASE	1PC
⑦		BACK SAFETY RAIL	1PC
⑧		FRONT SAFETY RAIL	1PC
⑨		LADDER	1PC
⑩		LADDER SUPPORT BAR	1PC

CARE & MAINTENANCE

- 1) No power tools shall be used for assembly of the bed . Use only allen keys provided for assembly.
- 2) Periodically check and ensure bolts are fully tightened

Method of Cleaning

- 1) Use damp cloth for normal cleaning.
- 2) For bright parts, use a clean dry duster only.

USE OF POWER TOOLS TO ASSEMBLE THIS PRODUCT WILL INVALIDATE ANY CLAIM AND MAY DAMAGE THIS PRODUCT, MAKING IT UNSAFE.



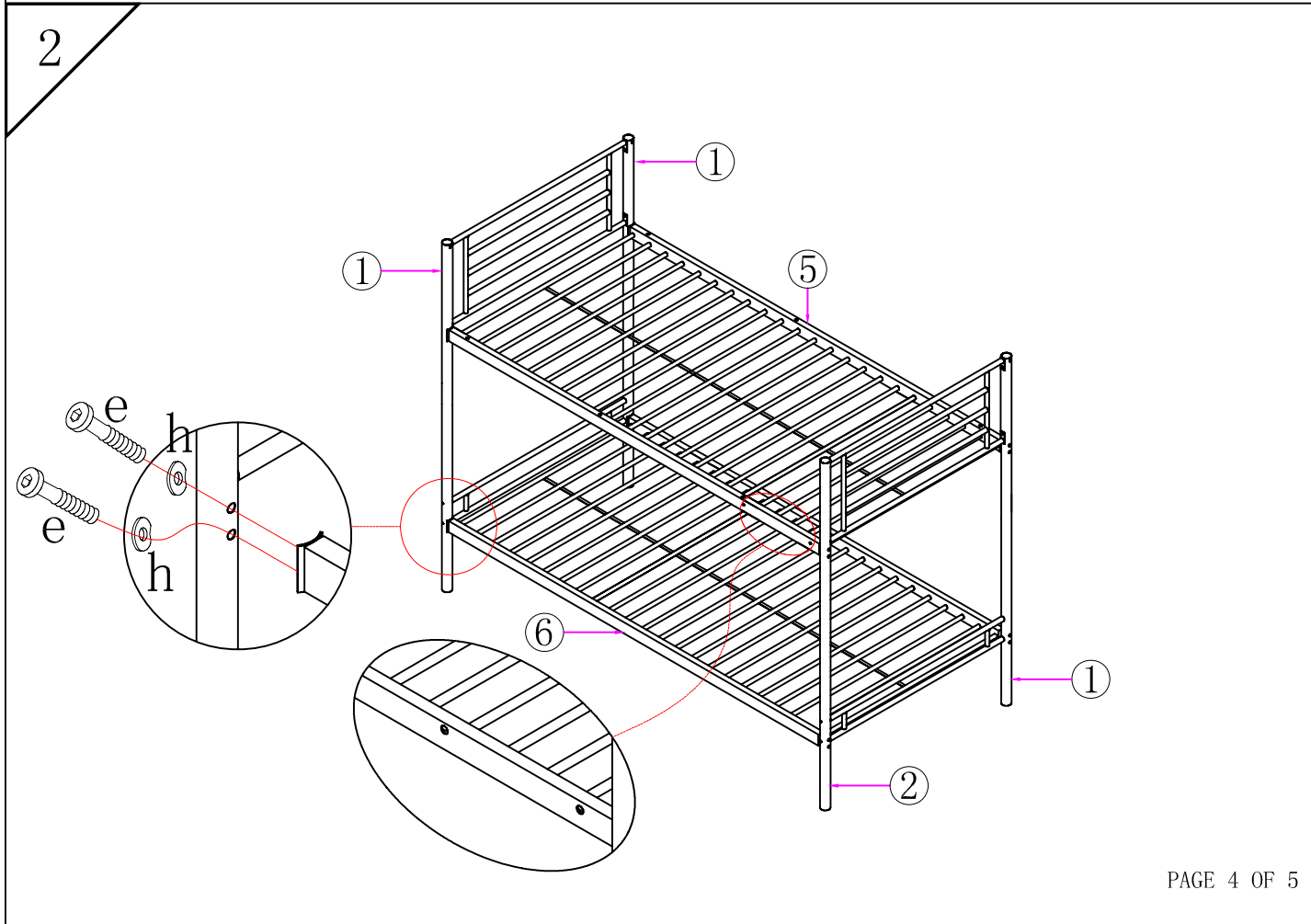
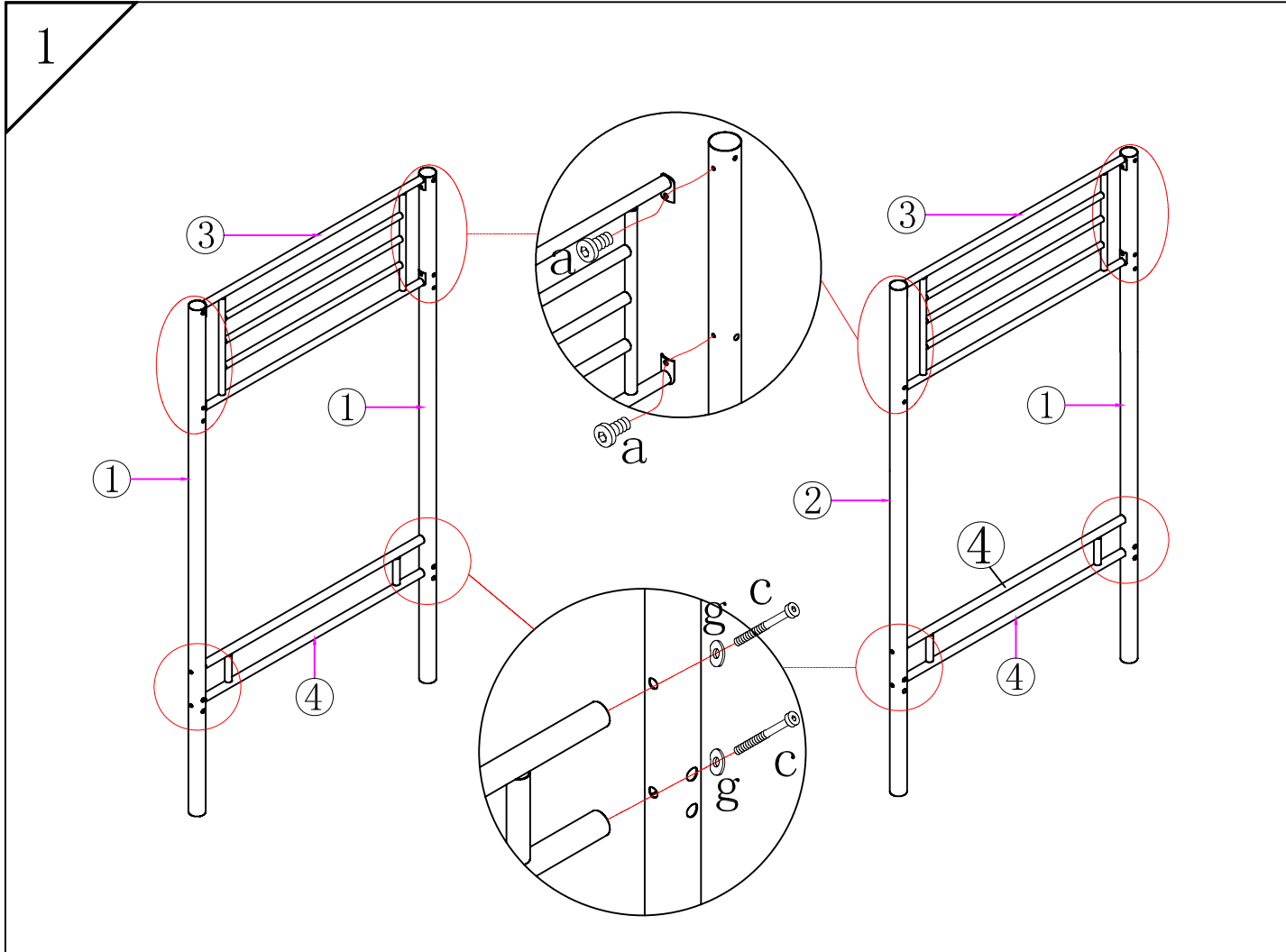

3

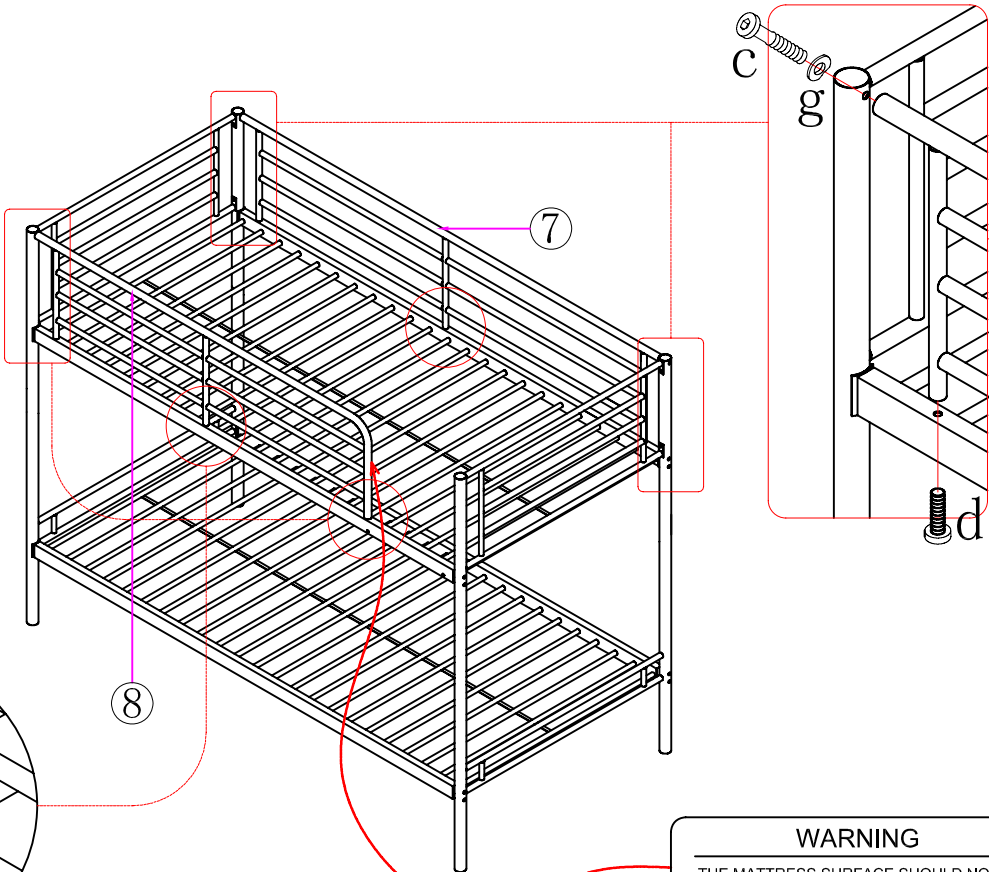

WARNING
THE MATTRESS SURFACE SHOULD NOT BE ABOVE THIS LINE

4

