

# BLUE VELVET FABRIC AMELIA 4'6" BED ASSEMBLY INSTRUCTIONS

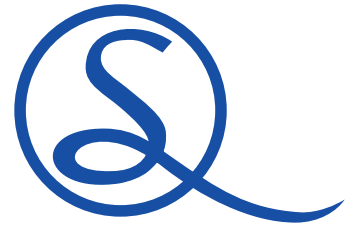
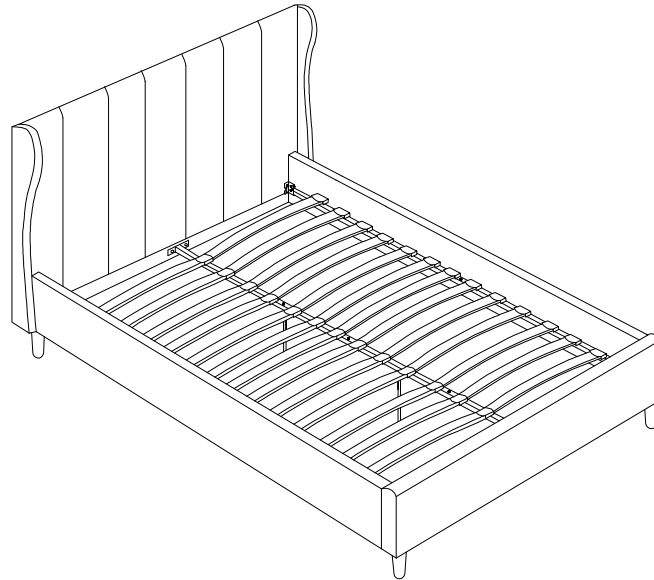
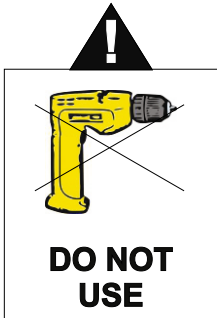

**MAX BED  
WEIGHT**

**FOR DOMESTIC USE ONLY  
IMPORTANT**

**PLEASE READ BEFORE YOU CONTINUE FURTHER**

THE PRODUCT YOU HAVE PURCHASED WILL GIVE YOU MANY YEARS OF SERVICE IF YOU FOLLOW THE GUIDELINES FOR ITS SAFE ASSEMBLY AND PERIODIC MAINTENANCE AND CLEANING.

ASSEMBLE ON A SOFT CLEAN SURFACE.

DO NOT USE ANY TOOLS OTHER THAN THOSE SHOWN.

ANY SPANNERS OR ALLEN KEYS REQUIRED ARE INCLUDED WITH THE FITTINGS KIT.

DO NOT FOR ANY REASON USE A POWER TOOL TO ASSEMBLE THIS PRODUCT . ITS USE WILL INVALIDATE ANY CLAIM YOU MAY HAVE AND COULD MAKE THIS PRODUCT UNSAFE.

DEPENDING ON THE AMOUNT OF USE THIS PRODUCT RECEIVES IT MAY BE NECESSARY TO TIGHTEN UP THE FIXINGS FROM TIME TO TIME. THIS IS COMPLETELY NORMAL FOR ANY FLAT PACK FURNITURE.

**FOR CLEANING YOU MAY USE A DAMP CLOTH(NOT WET). DO NOT USE POLISH,DETERGENT OR CHEMICAL CLEANERS.**

THIS PRODUCT MAY STAIN OR MARK IF ALLOWED TO COME INTO CONTACT WITH WET OR DAMP OBJECTS AS MATERIALS USED HAVE NOT BEEN SCOTCH GUARDED.

THE SURFACE OF THIS ITEM IS NOT HEAT RESISTANT, ALWAYS USE A PLACE MAT UNDER HOT OR COLD ITEMS. PREVENT MARKING

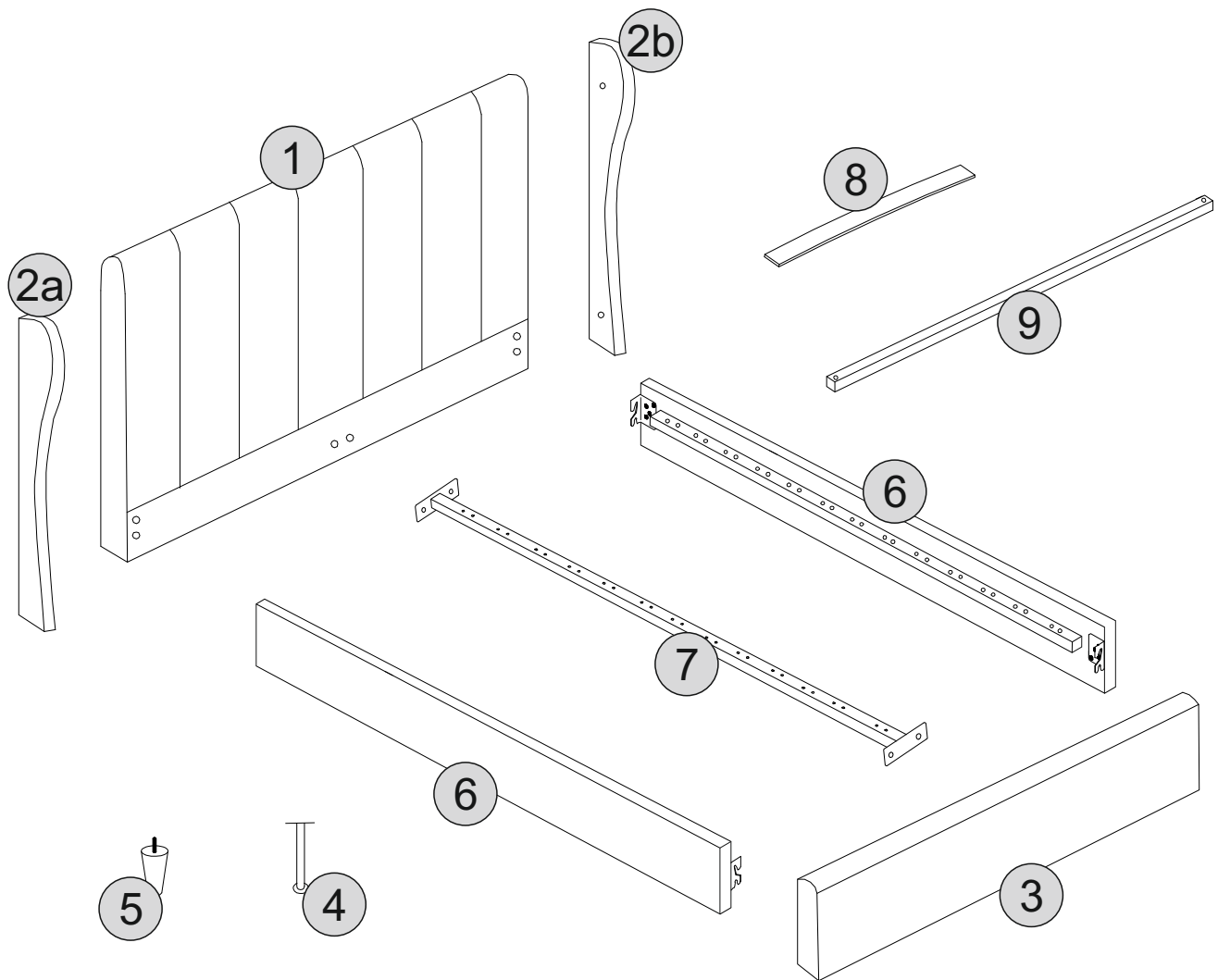







## PART LIST

Part Number	Part Code	Part Description	Quantity	Carton
1	S200-203-104-YF1-01	Headboard	1	1/2
2a	S200-203-104-YF1-02A	Left Wing	1	1/2
2b	S200-203-104-YF1-02B	Right Wing	1	1/2
3	S200-203-104-YF1-03	Footboard	1	2/2
4	S200-203-104-YF1-04	Centre Support Leg	2	1/2
5	S200-203-104-YF1-05	Wooden Feet	4	2/2
6	S200-203-104-YF1-06	Side Rail	2	2/2
7	S200-203-104-YF1-07	Centre Rail	1	1/2
8	S200-203-104-YF1-08	Wooden Slat	26	2/2
9	S200-203-104-YF1-09	Centre Cross Rail	1	2/2

PLEASE CHECK THAT YOU HAVE ALL THE PARTS LISTED BEFORE YOU START ASSEMBLING, IF YOU DO FIND THAT SOMETHING IS MISSING, DO NOT CONTINUE ASSEMBLY. PLEASE CONTACT YOUR SUPPLIER IMMEDIATELY.

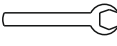
## HARDWARE LIST

No	Part Name		Qty	Carton
A	5/16 x 25mm Bolt		x12	2/2
B	5/16 x 50mm Bolt		x11	2/2
C	M8 Washer		x18	2/2
D	Nut		x7	2/2
E	Allen Key		x1	2/2
F	Spanner		x1	2/2
G	Plastic Centre Cap		x13	1/2
H	Plastic End Cap		x26	1/2

PLEASE CHECK THAT YOU HAVE ALL THE PARTS LISTED BEFORE YOU START ASSEMBLING, IF YOU DO FIND THAT SOMETHING IS MISSING, DO NOT CONTINUE ASSEMBLY. PLEASE CONTACT YOUR SUPPLIER IMMEDIATELY.

# STEP 1

## PARTS REQUIRED

1 - HEADBOARD	x1
---------------	----

5 - WOODEN FEET	x2
-----------------	----

## HARDWARE REQUIRED

## TOOLS REQUIRED

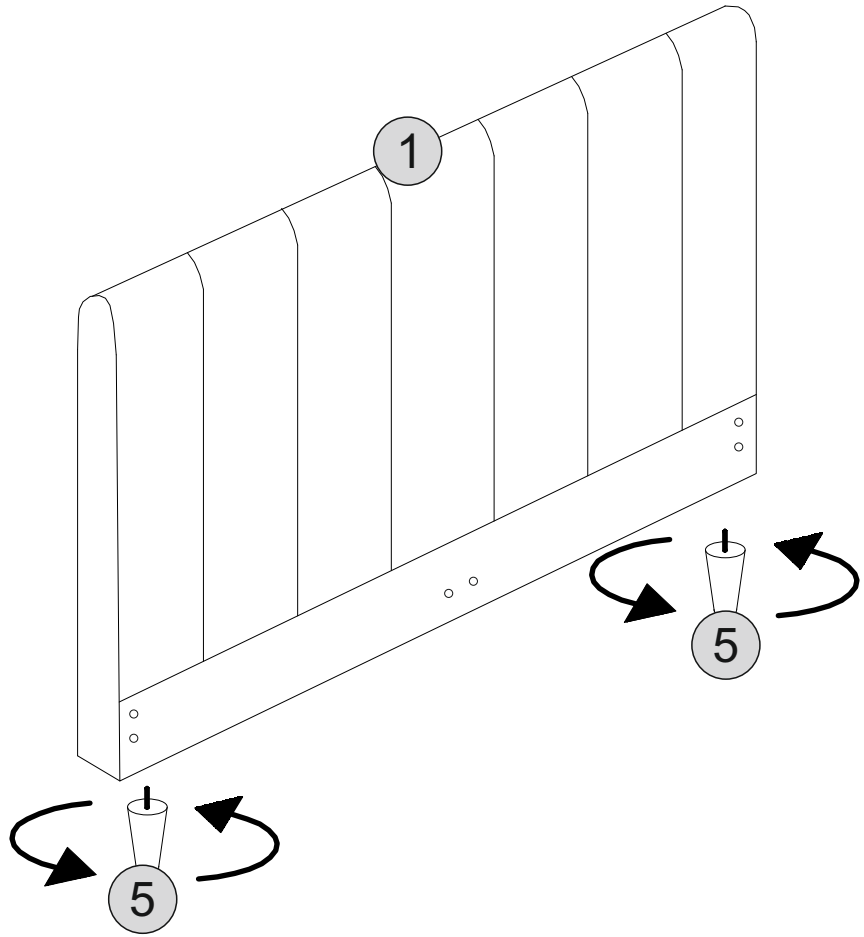

# STEP 2

## PARTS REQUIRED

3 - FOOTBOARD	x1
---------------	----

5 - WOODEN FEET	x2
-----------------	----

## HARDWARE REQUIRED

## TOOLS REQUIRED

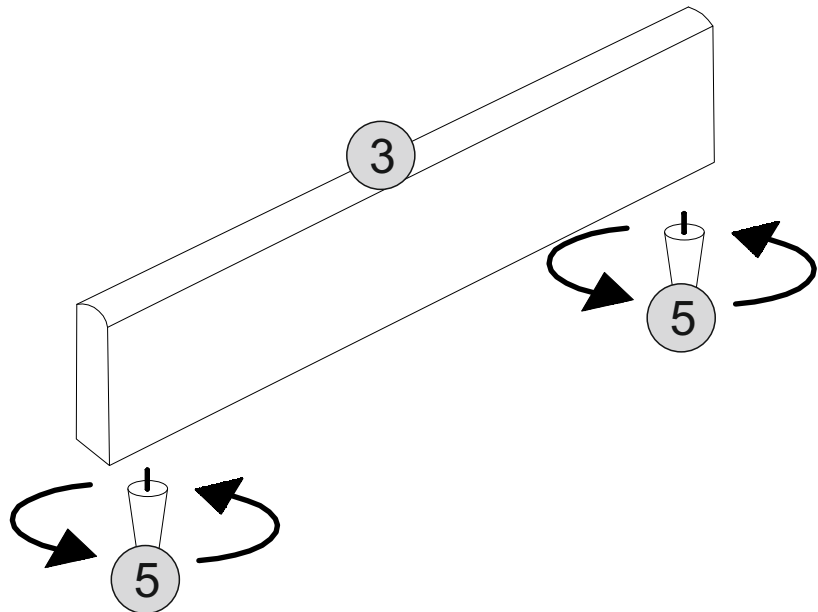

# STEP 3

## PARTS REQUIRED

1 - HEADBOARD	x1
3 - FOOTBOARD	x1
6 - SIDE RAIL	x2

## HARDWARE REQUIRED

A		08
---	---	----

## TOOLS REQUIRED

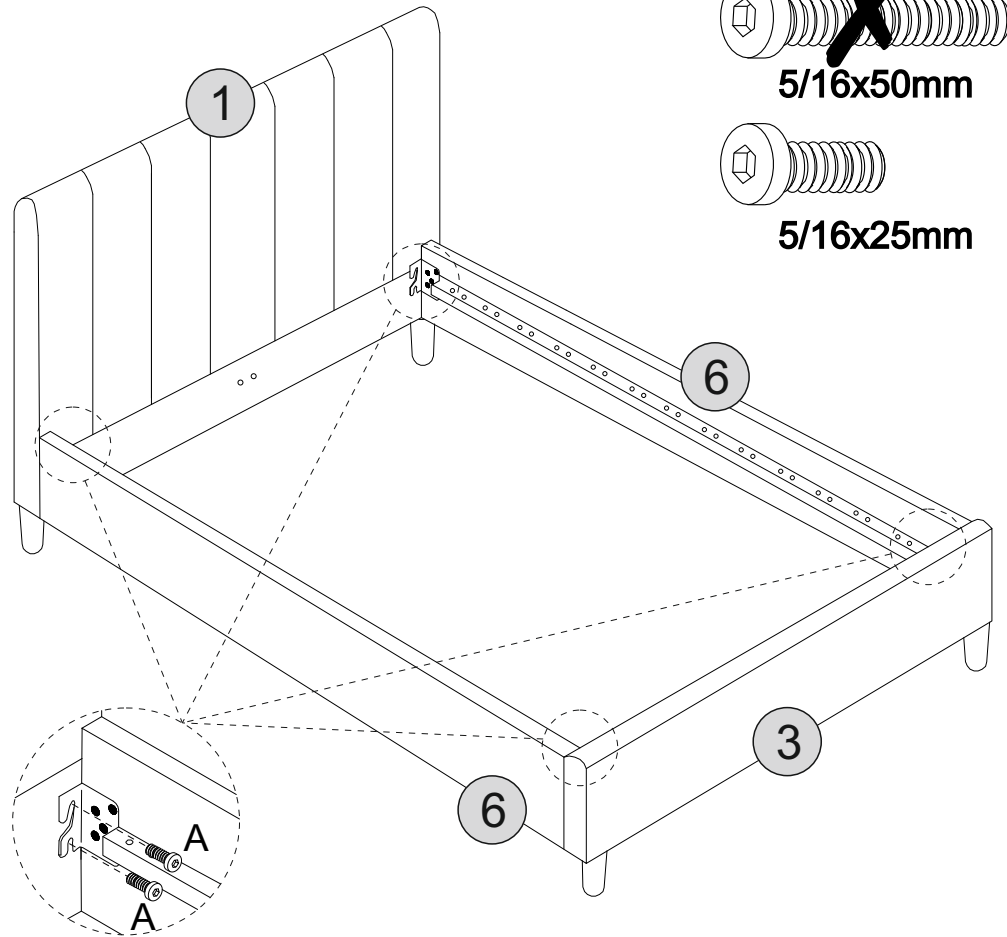



# STEP 4

## PARTS REQUIRED

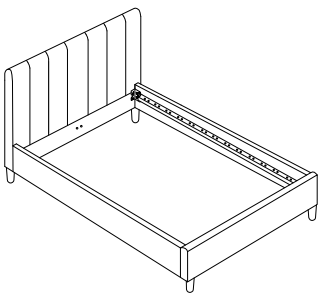
4 - CENTRE SUPPORT LEG	x2
7 - CENTRE RAIL	x1



## HARDWARE REQUIRED

B		04
C		08
D		04

## TOOLS REQUIRED

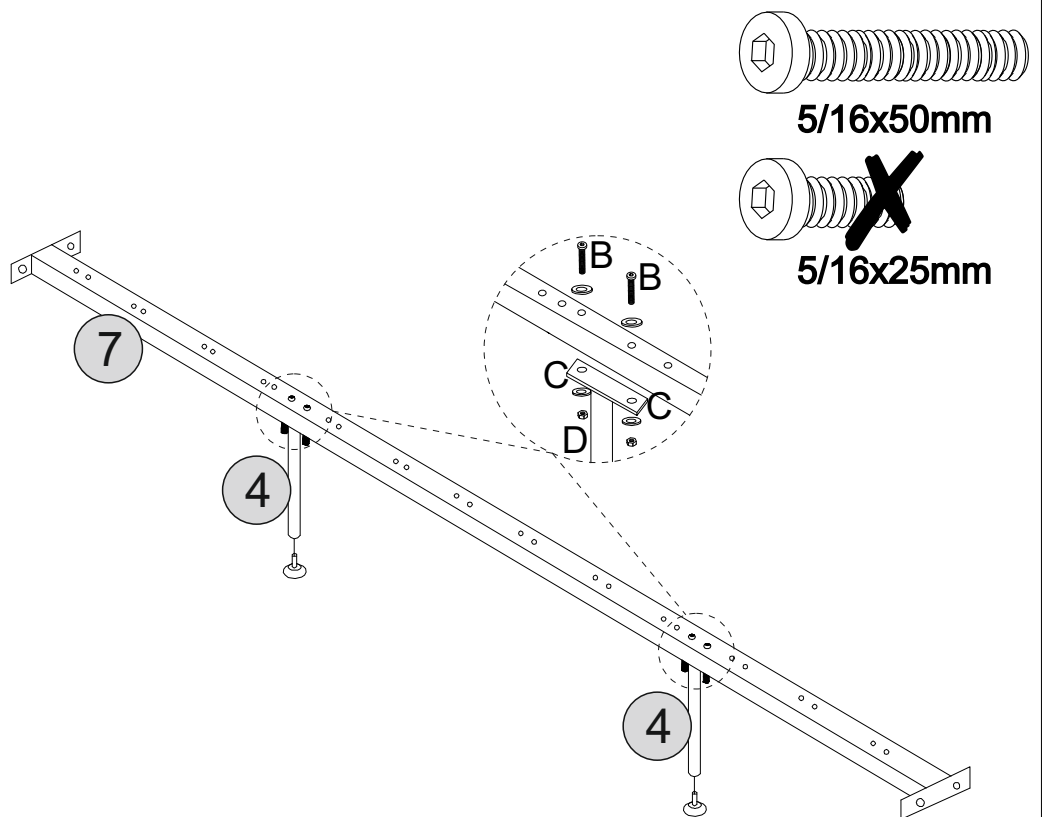
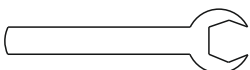



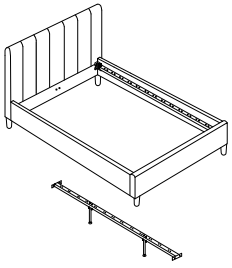

# STEP 5

## PARTS REQUIRED

9 - CENTRE CROSS RAIL x1



## HARDWARE REQUIRED

A	 5/16x25mm	04
B	 5/16x50mm	03
C		06
D		03

## TOOLS REQUIRED

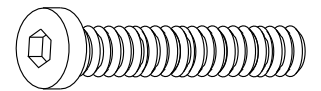
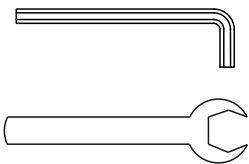

5/16x50mm

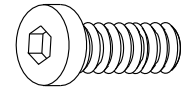

5/16x25mm

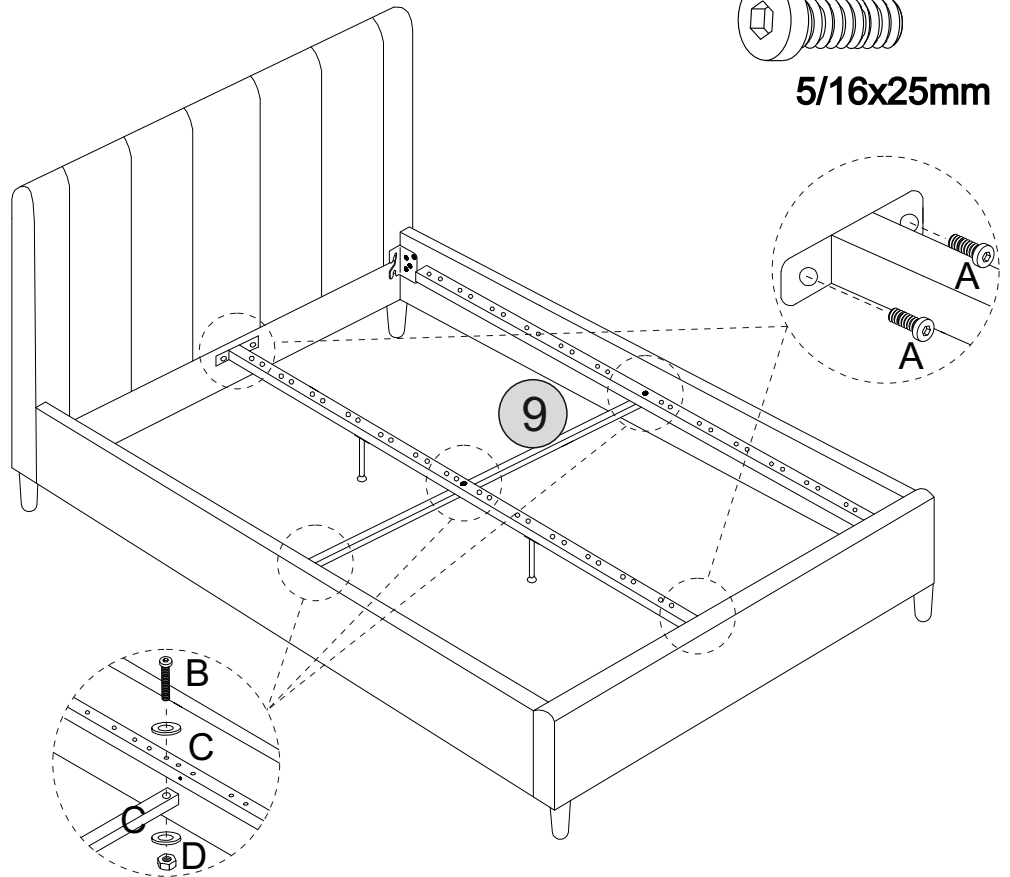



# STEP 6

## PARTS REQUIRED

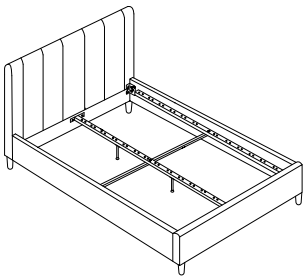
8 - WOODEN SLAT x26



## HARDWARE REQUIRED

G		13
H		26

## TOOLS REQUIRED

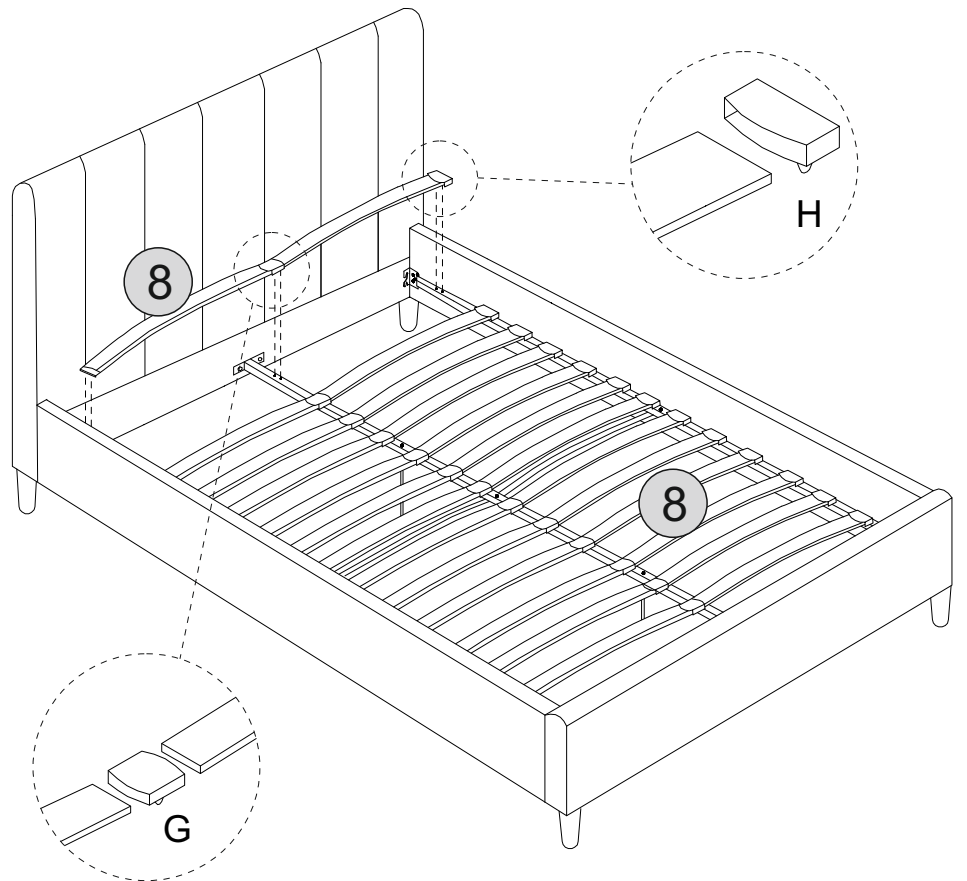



# STEP 7

**PARTS REQUIRED**

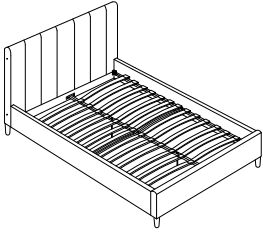
2a - LEFT WING	x1
2b - RIGHT WING	x1



**HARDWARE REQUIRED**

B		04
C		04

**TOOLS REQUIRED**

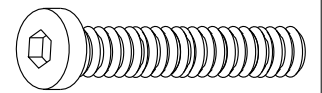
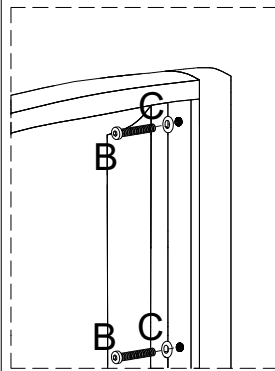

5/16x50mm

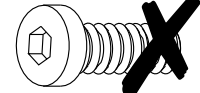

5/16x25mm

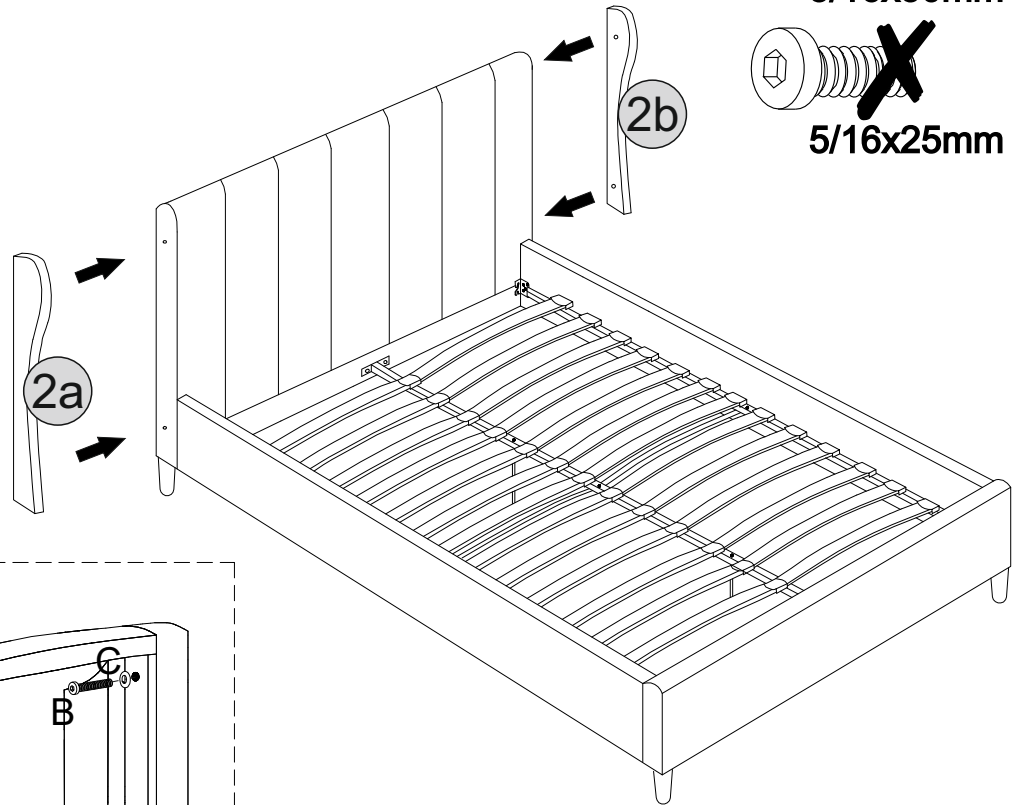

# STEP 8

**PARTS REQUIRED**

**HARDWARE REQUIRED**

**TOOLS REQUIRED**

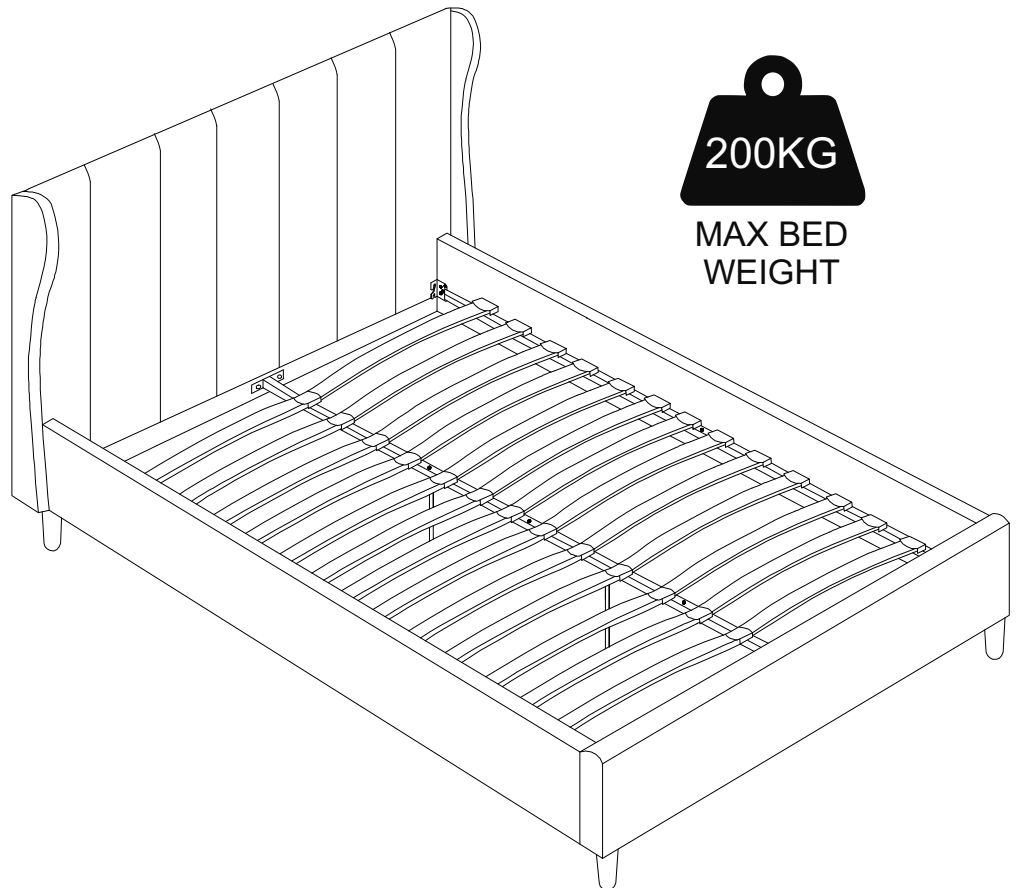

200KG  
MAX BED WEIGHT