

CODY 2 DOOR 1 DRAWER WARDROBE ASSEMBLY INSTRUCTIONS WHITE/PINE EFFECT

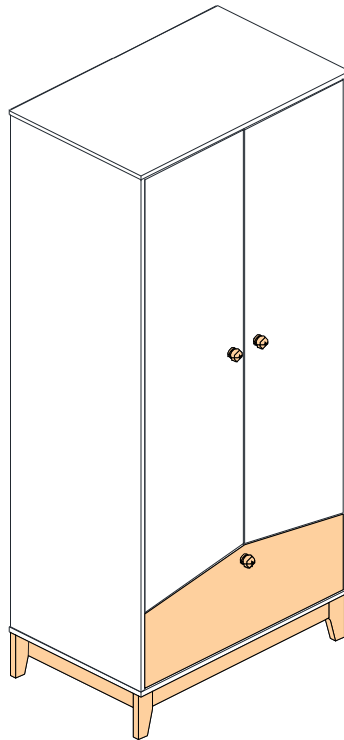

IMPORTANT FOR DOMESTIC USE ONLY

PLEASE READ BEFORE YOU CONTINUE FURTHER

CARE AND MAINTENANCE

After unpacking this product please keep the original packaging in case it needs to be returned for any reason.

- Please ensure all fittings and parts are present before commencing with assembly.
- Never drag or push products as this could cause damage to the joints making it inferior.
- We strongly recommend that you keep children away from your work area.
- We recommend that you lay a blanket or sheet on the floor to avoid damage to both your floor and the product.
- Assemble this product as close to its final position as possible.
- Do not place this product next to a radiator or in direct sunlight.
- Do not drag or push items across your high gloss furniture as this may cause the surface to scratch
- Wood is a natural product and may expand if subjected to damp and may shrink or crack if subjected to heat. Therefore it is recommended that room temperature is maintained, with no sudden temperature fluctuations.
- Make sure any spillage is wiped off immediately.
- Do not place hot or chilled items directly on to the surface, use a place mat or marking will occur.
- For general cleaning use a soft cotton or micro fibre cloth, and do not use detergents of any kind.
- From time to time it may be necessary to tighten fittings, regular inspections should be carried out.
- Do not place on a wet or damp floor as staining may occur to your floor.

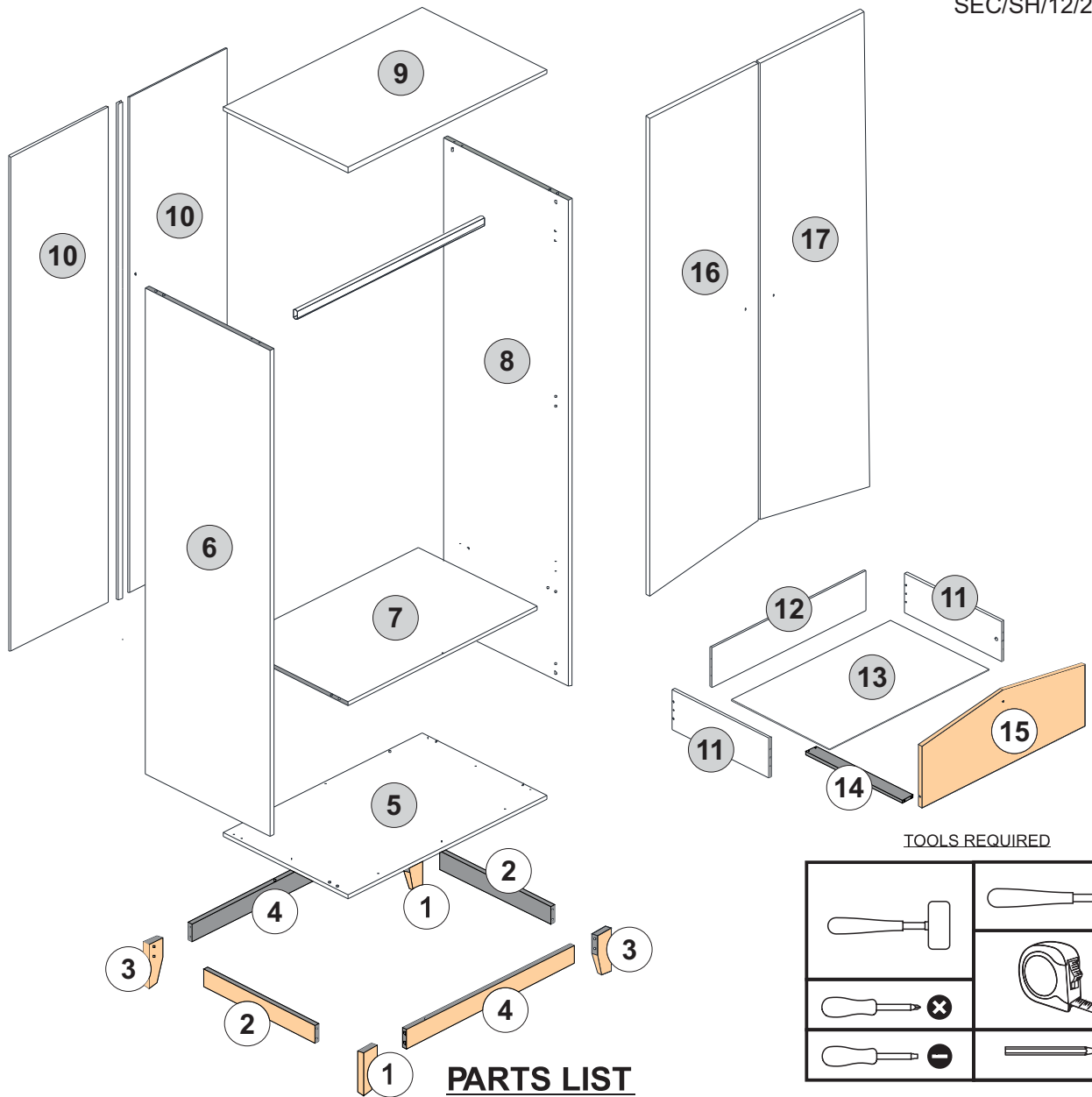













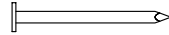

PARTS LIST

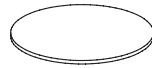
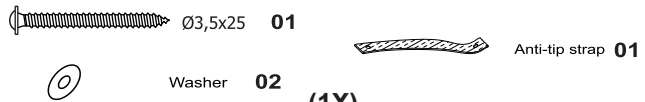
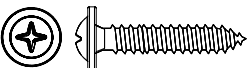
Please Note:
The below parts have all been stamped with the part number to help identify them during assembly.

Part Number	Part Code	Part Description	Quantity	Carton
1	S100-101-186-DV1-01	Left Leg	2	2/2
2	S100-101-186-DV1-02	Leg Support Left & Right	2	2/2
3	S100-101-186-DV1-03	Right Leg	2	2/2
4	S100-101-186-DV1-04	Leg Support Front & Back	2	2/2
5	S100-101-186-DV1-05	Base Panel	1	2/2
6	S100-101-186-DV1-06	Left Side Panel	1	1/2
7	S100-101-186-DV1-07	Shelf	1	2/2
8	S100-101-186-DV1-08	Right Side Panel	1	1/2
9	S100-101-186-DV1-09	Top Panel	1	2/2
10	S100-101-186-DV1-10	Back Panel	2	1/2
11	S100-101-186-DV1-11	Drawer Sides	2	2/2
12	S100-101-186-DV1-12	Drawer Back	1	2/2
13	S100-101-186-DV1-13	Drawer Base	1	2/2
14	S100-101-186-DV1-14	Drawer Base Support	1	2/2
15	S100-101-186-DV1-15	Drawer Front	1	2/2
16	S100-101-186-DV1-16	Left Door	1	1/2
17	S100-101-186-DV1-17	Right Door	1	1/2

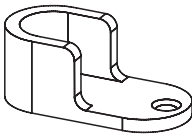
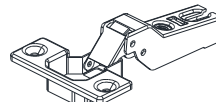
FITTINGS LIST

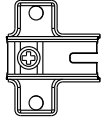
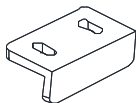
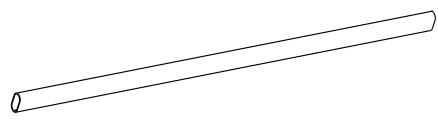
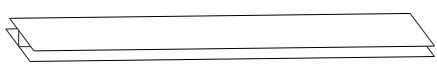
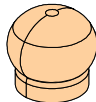
<p>A</p>  <p>Glue (3x)</p>	<p>B</p>  <p>Dowel Ø6,0 x 30mm (26x)</p>	<p>C</p>  <p>Slide 450mm (1x)</p>	<p>D</p>  <p>Flat Head Screw Ø4,0 x 40mm (8x)</p>
<p>E</p>  <p>Nail 10 x 10 (45x)</p>	<p>F</p>  <p>Cam Nut 12mm (6x)</p>	<p>G</p>  <p>Cam Bolt (22x)</p>	<p>H</p>  <p>Screw Ø 6x8 (4x)</p>
<p>I</p>  <p>Flat Head Screw Ø3,0 x 14mm (8x)</p>	<p>J</p>  <p>Hole Plugs (6x)</p>	<p>K</p>  <p>Washer 02 (1X) Anti-tip strap 01</p>	
<p>L</p>  <p>Flat Head Screw Ø4,0 x 30mm (3x)</p>	<p>M</p>  <p>Flat Head Screw Ø4,0 x 14mm (24x)</p>	<p>N</p>  <p>Dowel Ø8,0 x 30mm (8x)</p>	<p>O</p>  <p>Cam Nut 15mm (16x)</p>
<p>P</p>  <p>Flat Head Screw Ø3,5 x 25mm (2x)</p>	<p>Q</p>  <p>Hanging Rail Support (2x)</p>	<p>R</p>  <p>Hinge (6x)</p>	<p>S</p>  <p>Flat Head Screw Ø3,5 x 12mm (4x)</p>
<p>T</p>  <p>Hinge Plate (6x)</p>	<p>U</p>  <p>Door Stop (2x)</p>	<p>V</p>  <p>Hanging Rail 760mm (1x)</p>	
<p>W</p>  <p>Plastic profile 1596 mm (1x)</p>		<p>Y</p>  <p>Handle(3x)</p>	

TIPS FOR FITTINGS CAM-LOCKS

WHEN FITTING CAM NUT. ENSURE STARTING POSITION IS CORRECT BEFORE YOU INSERT CONNECTING CAM BOLT TURN CLOCKWISE UNTIL SECURE

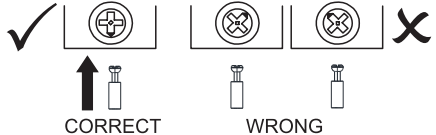

CORRECT **WRONG**

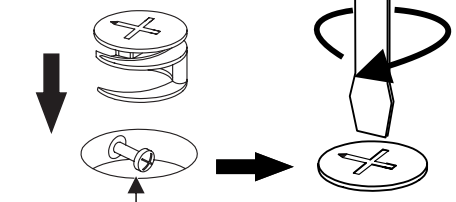

Cam bolt head needs to be in centre

CAMBOLT

Tighten until shoulder in flush with panel. Do not overtighten or undertighten (see example beside)

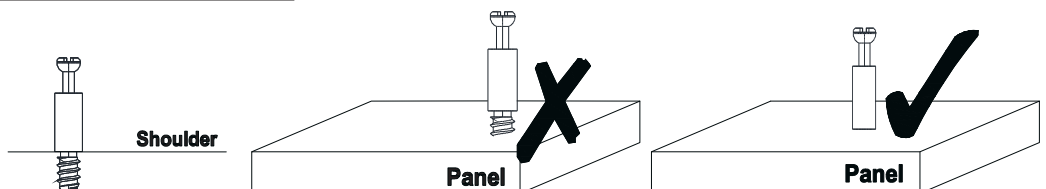

STEP 1

PARTS REQUIRED

1 - LEFT LEG x2

3 - RIGHT LEG x2

HARDWARE REQUIRED

G  08

TOOLS REQUIRED

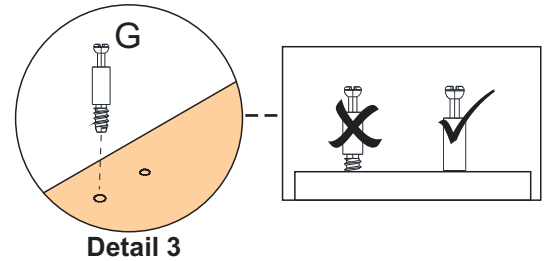
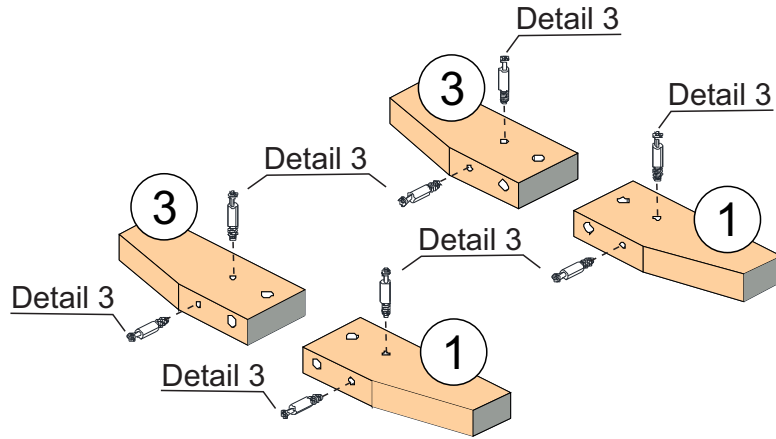
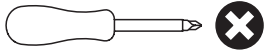

STEP 2

PARTS REQUIRED

2- LEG SUPPORT LEFT+RIGHT x2

4- LEG SUPPORT FRONT+BACK x2

HARDWARE REQUIRED

A  01

B  Ø6 x 30mm 04

N  Ø8 x 30mm 08

TOOLS REQUIRED

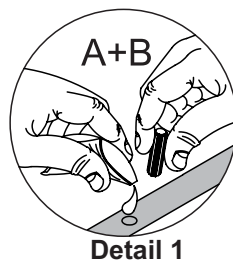
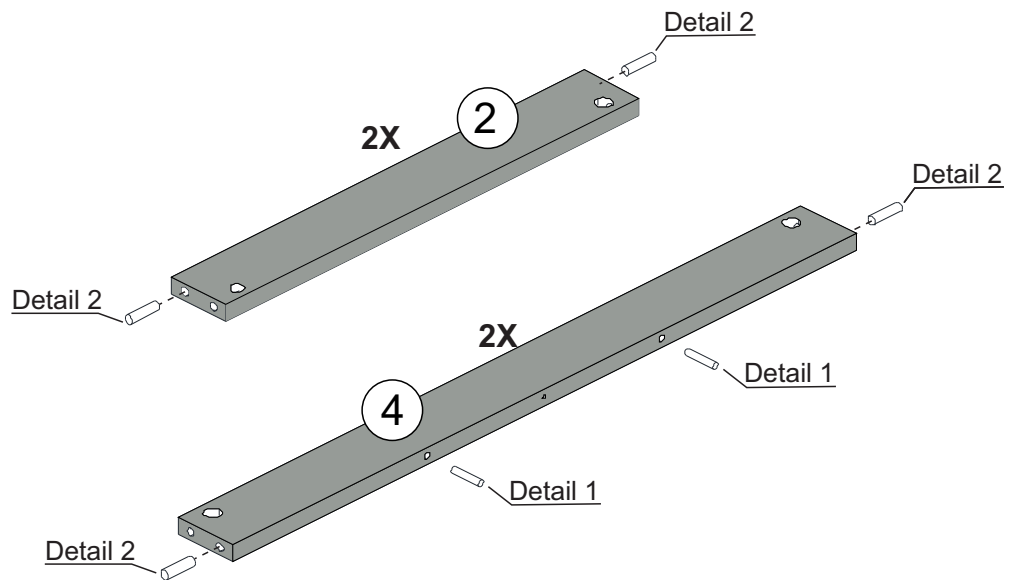
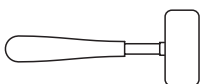





STEP 3

PARTS REQUIRED

7- SHELF x1

HARDWARE REQUIRED

- A  01
- B  Ø6 x 30mm 04
- S  Ø3,5 x 12mm 02
- U  01

TOOLS REQUIRED

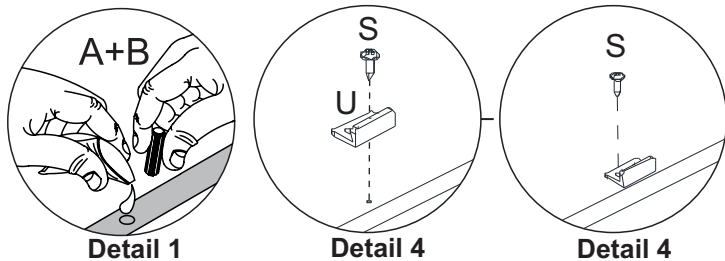
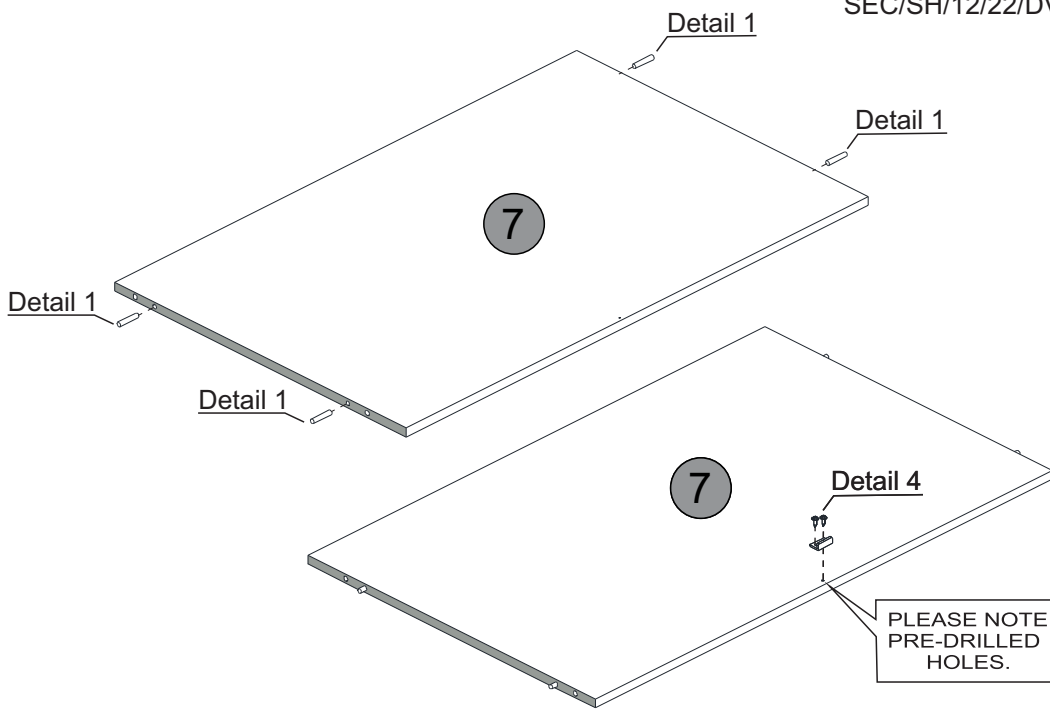
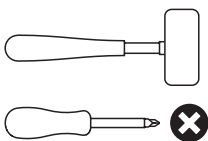



STEP 4

PARTS REQUIRED

9 - TOP PANEL x1

HARDWARE REQUIRED

- G  04
- S  Ø3,5 x 12mm 02
- U  01

TOOLS REQUIRED

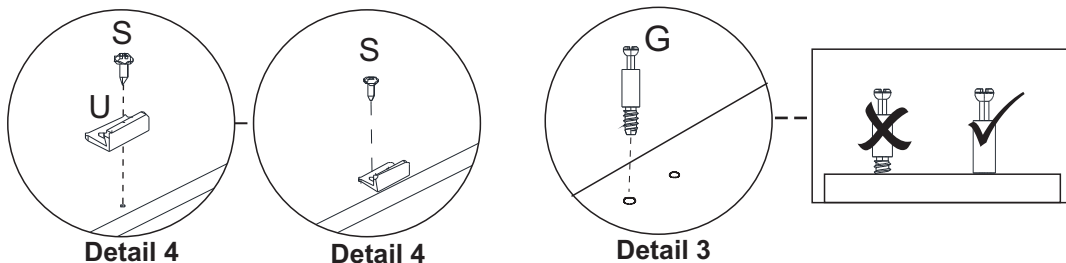
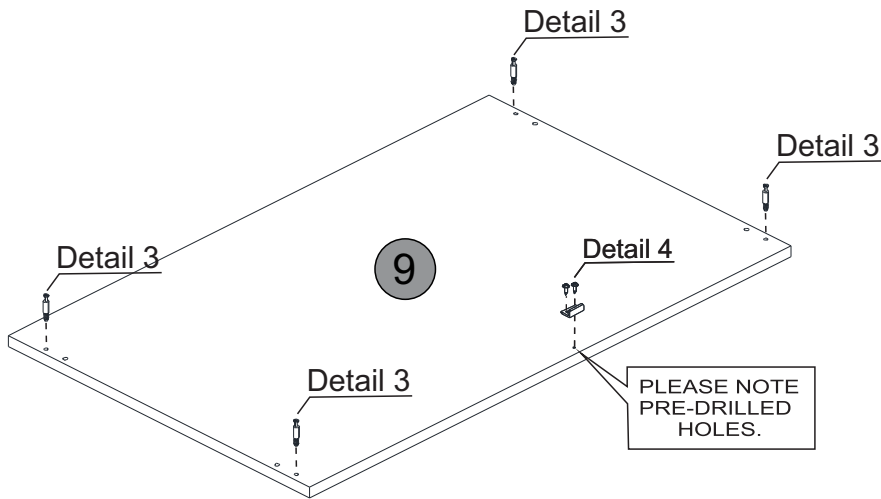
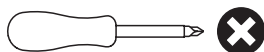



STEP 5

PARTS REQUIRED

6- LEFT SIDE PANEL x1

HARDWARE REQUIRED

A  01

B  Ø6 x 30mm 04

G  02

TOOLS REQUIRED

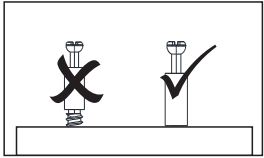
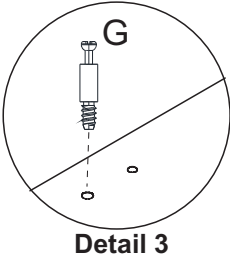
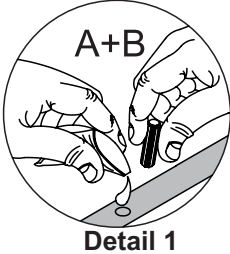
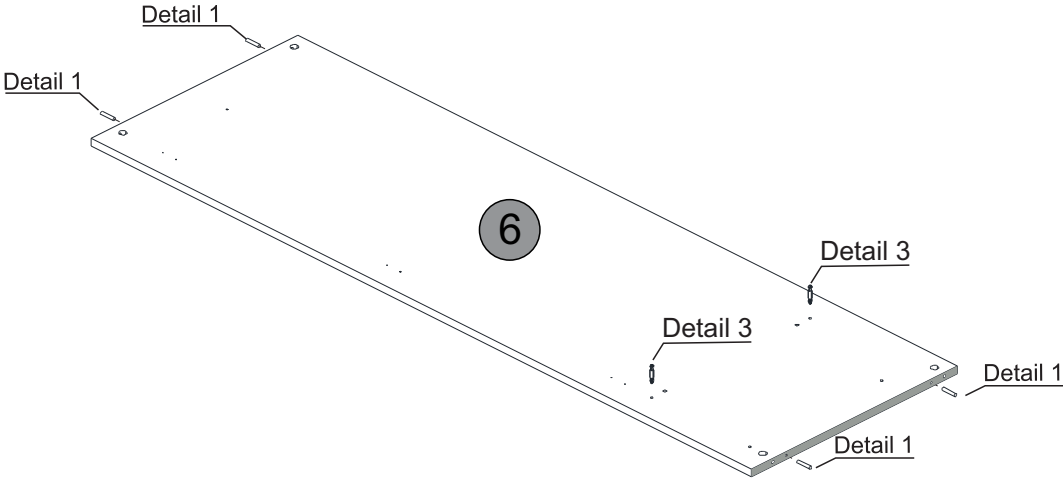
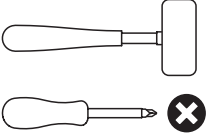

STEP 6

PARTS REQUIRED

6- LEFT SIDE PANEL x1

HARDWARE REQUIRED

I  Ø3,0 x 14mm 02

M  Ø4,0 x 14mm 06

Q  01

T  03

TOOLS REQUIRED

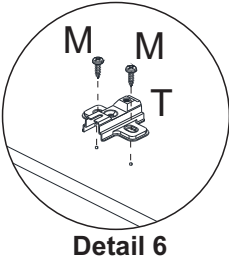
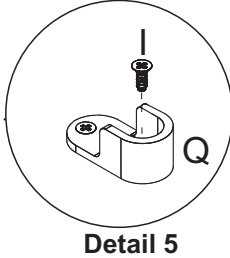
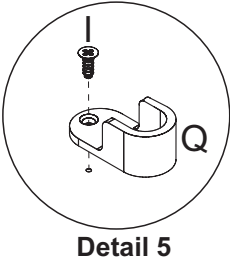
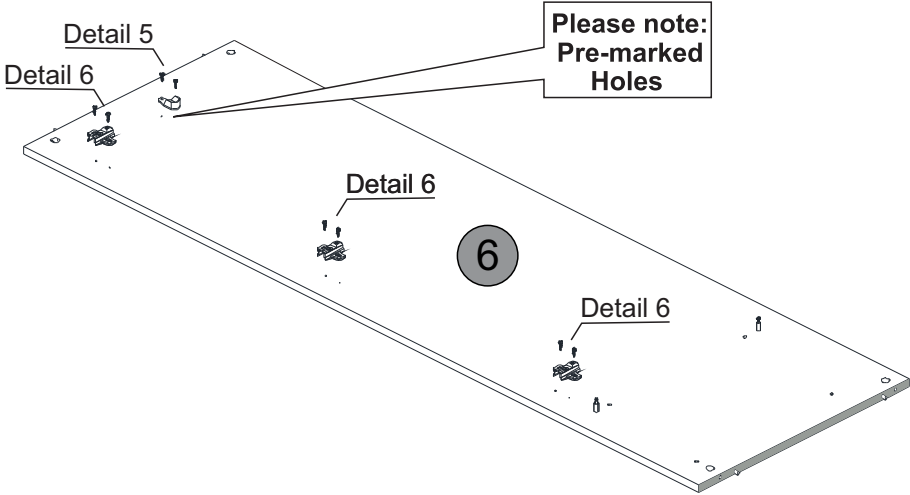
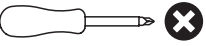

STEP 7

PARTS REQUIRED

6- LEFT SIDE PANEL x1

HARDWARE REQUIRED

C  01
450mm

H  02
Ø6 x 8mm

TOOLS REQUIRED

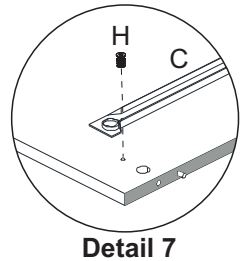
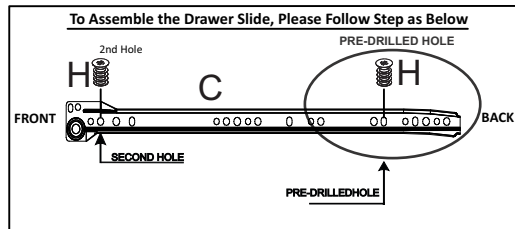
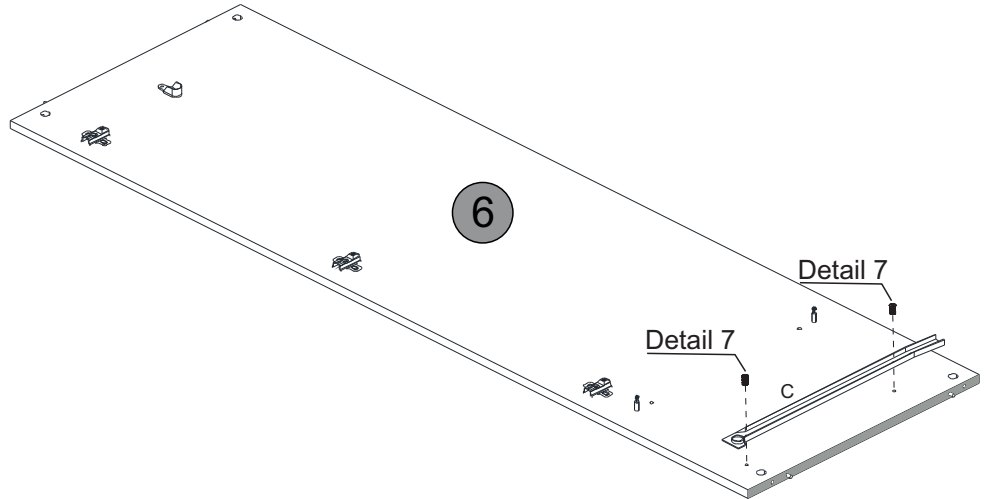
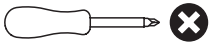



STEP 8

PARTS REQUIRED

8- RIGHT SIDE PANEL x1

HARDWARE REQUIRED

A  01

B  04
Ø6 x 30mm

G  02

TOOLS REQUIRED

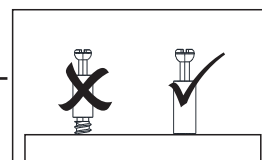
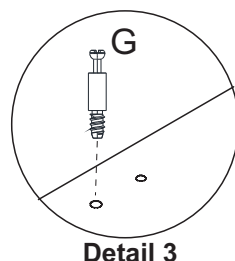
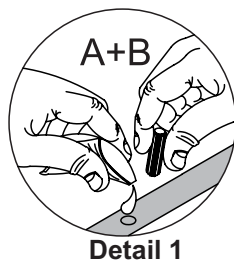
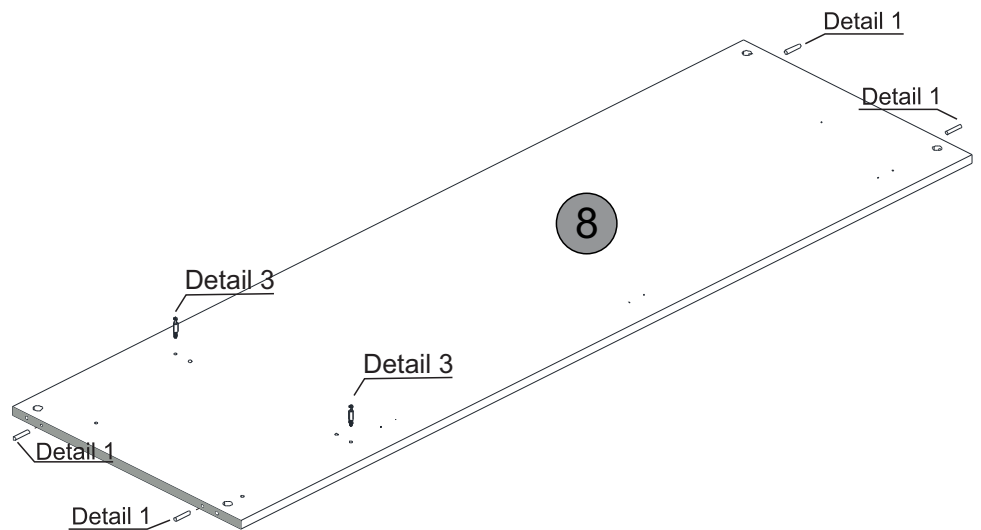
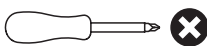
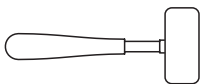

STEP 9

PARTS REQUIRED

8- RIGHT SIDE PANEL x1

HARDWARE REQUIRED

I  02
Ø3.0 x 14mm

M  06
Ø4.0 x 14mm

Q  01

T  03

TOOLS REQUIRED

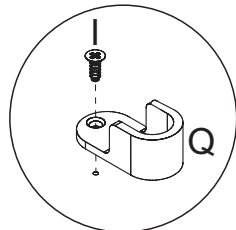
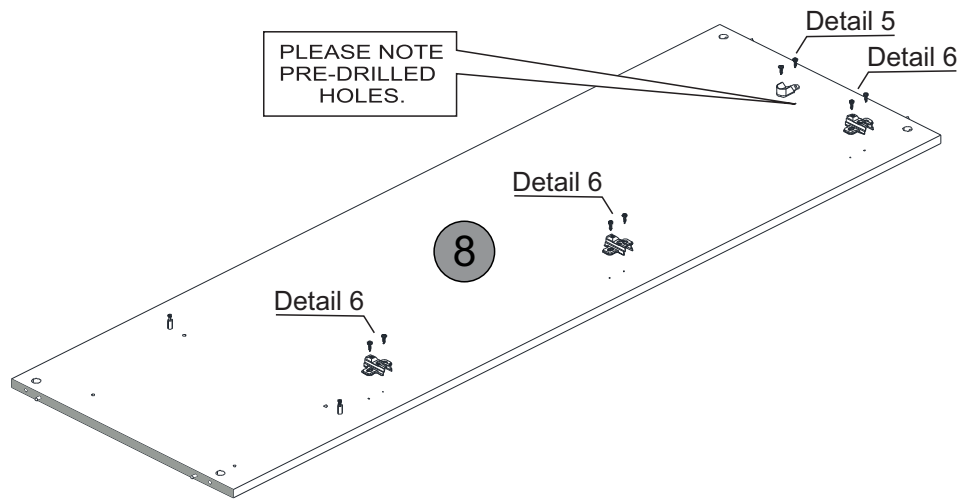
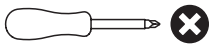

Detail 5

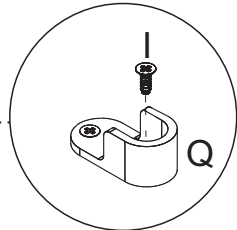

Detail 5

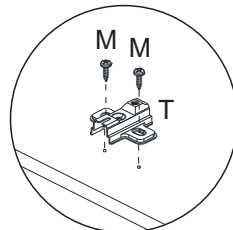

Detail 6

STEP 10

PARTS REQUIRED

8- RIGHT SIDE PANEL x1

HARDWARE REQUIRED

C  01
450mm Right

H  02
Ø6 x 8mm

TOOLS REQUIRED

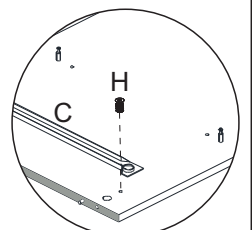
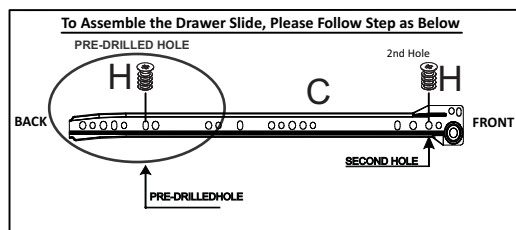
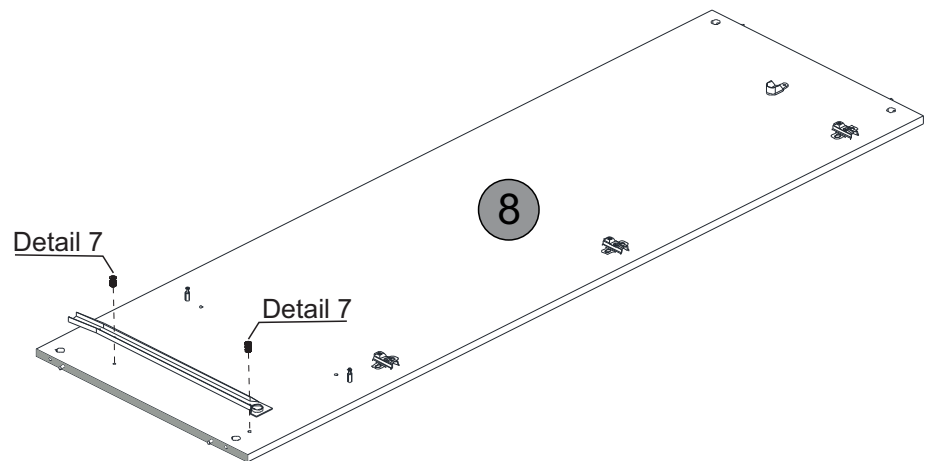
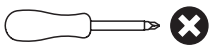



Detail 7

STEP 11

PARTS REQUIRED

1- LEFT FOOT	x2
3- RIGHT FOOT	x2
4- FRONT AND REAR FOOTER	x2

HARDWARE REQUIRED

A		01
O		04

TOOLS REQUIRED

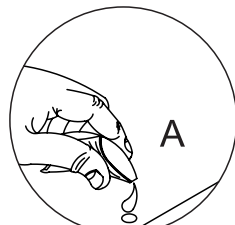
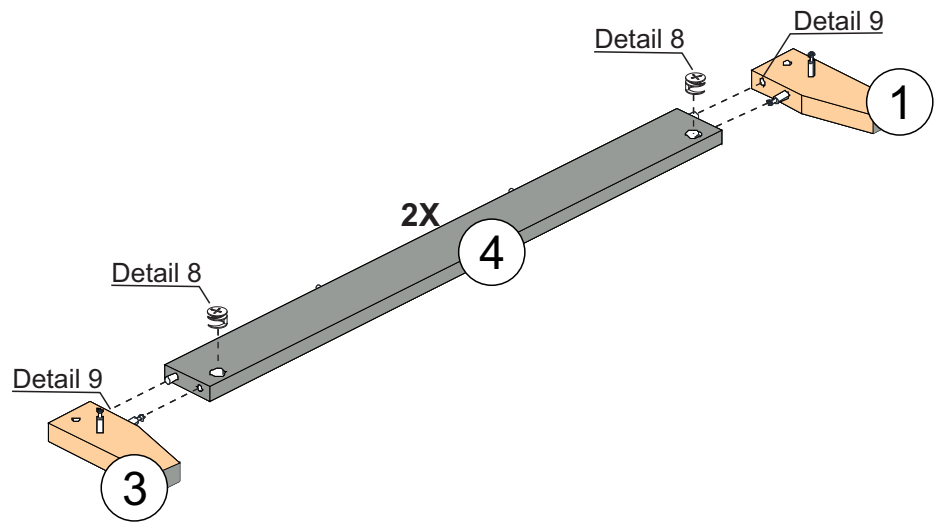
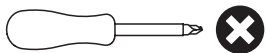

Detail 9

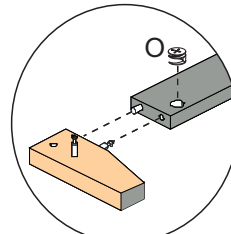

Detail 8

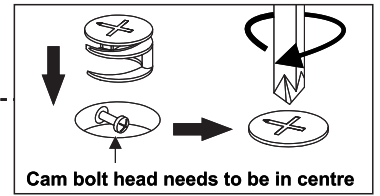



STEP 12

PARTS REQUIRED

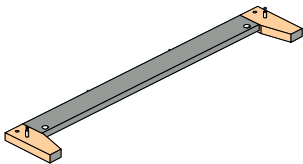
2- SIDE FOOTER	x2
----------------	----



HARDWARE REQUIRED

A		01
O		02

TOOLS REQUIRED

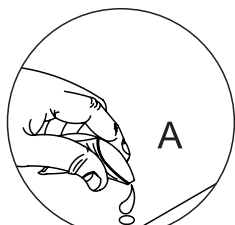
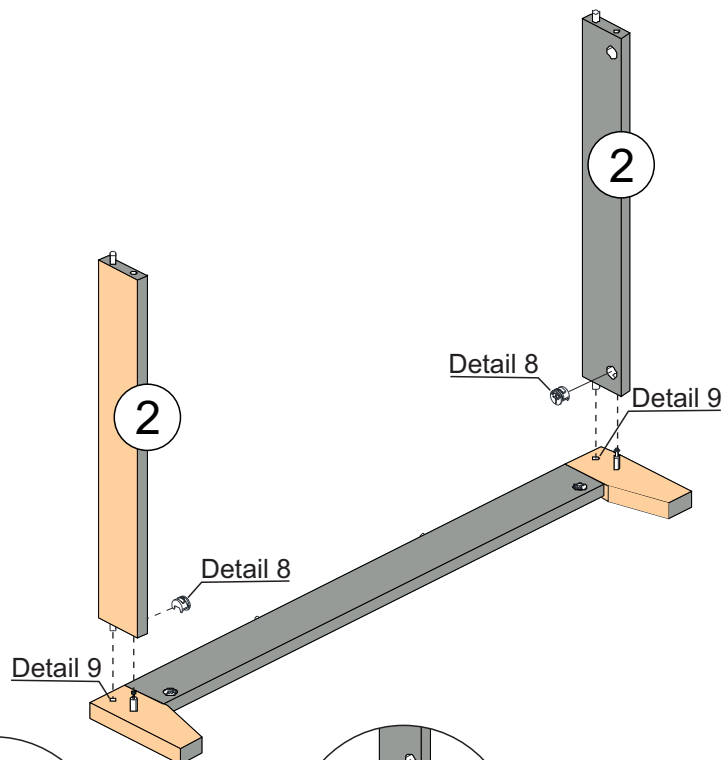

Detail 9

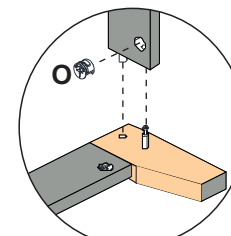

Detail 8

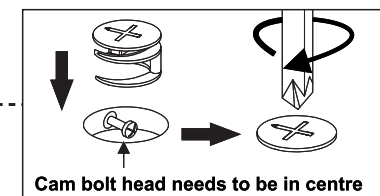

STEP 13

PARTS REQUIRED

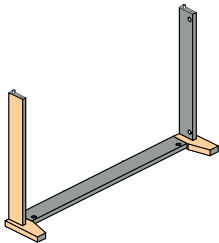

HARDWARE REQUIRED

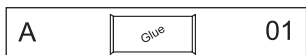

TOOLS REQUIRED

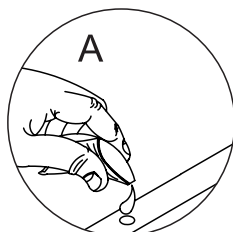
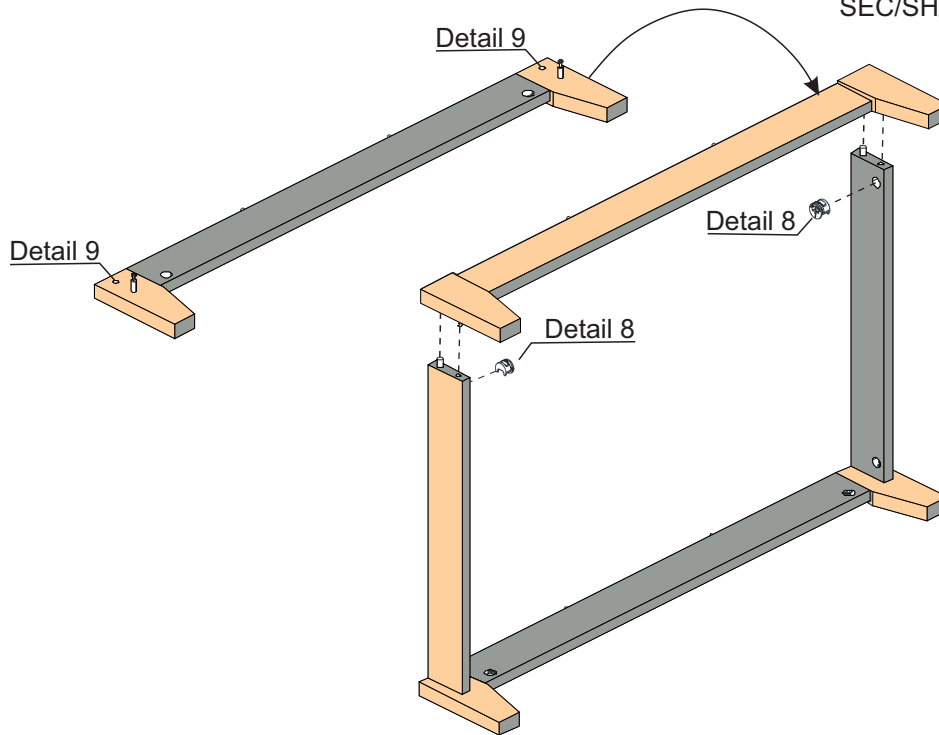
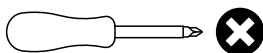

Detail 9

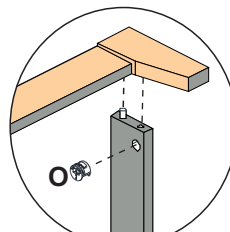

Detail 8

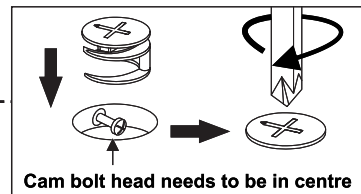

STEP 14

PARTS REQUIRED

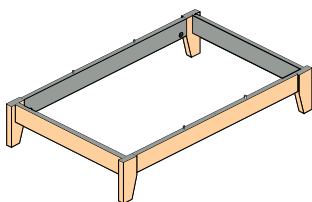

HARDWARE REQUIRED

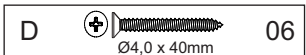
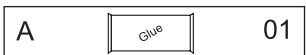

TOOLS REQUIRED

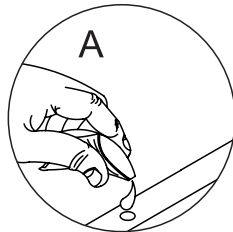
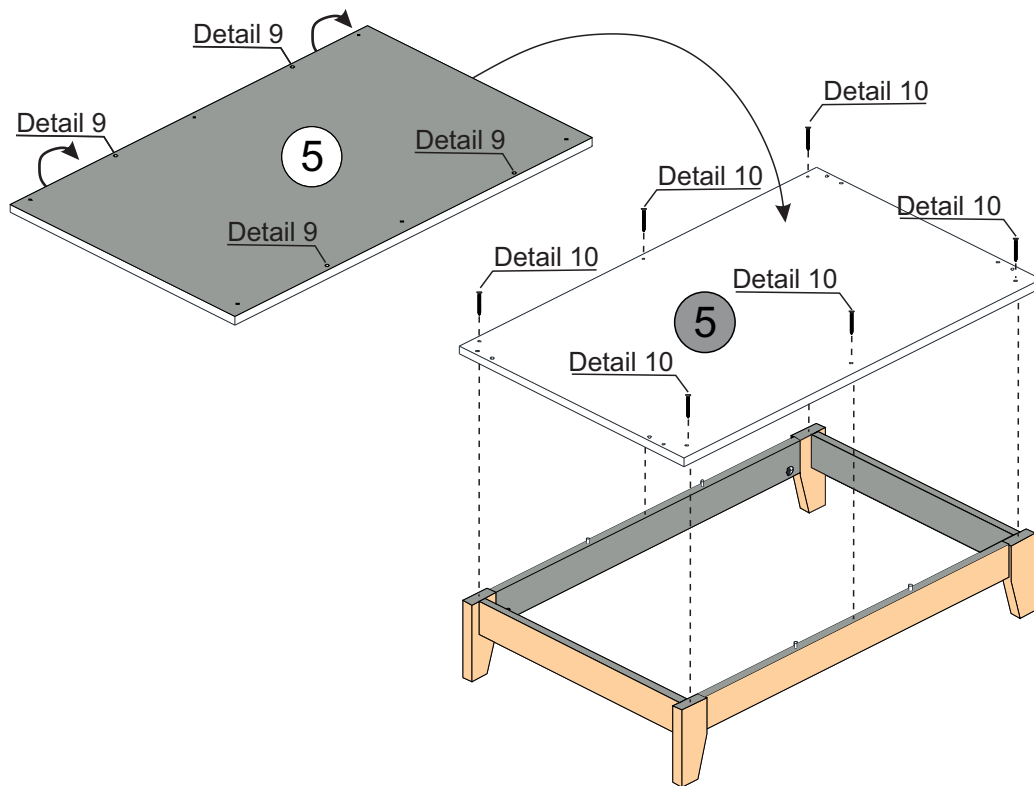
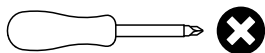

Detail 9

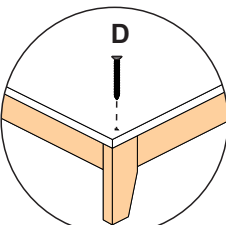

Detail 10

STEP 15

PARTS REQUIRED

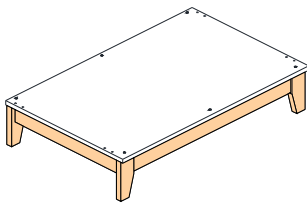

HARDWARE REQUIRED

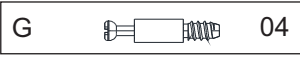

TOOLS REQUIRED

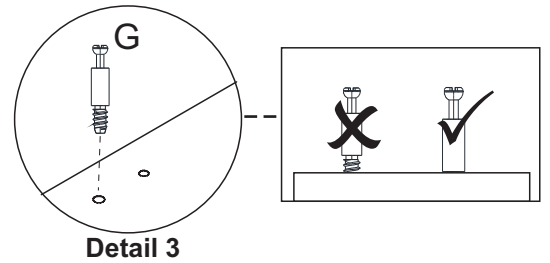
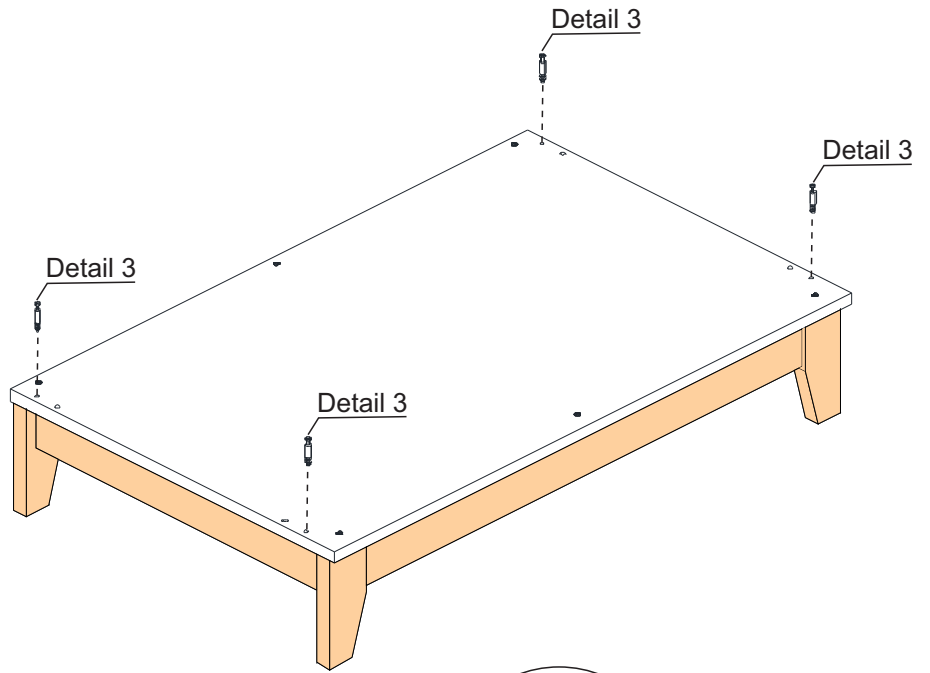
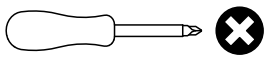

STEP 16

PARTS REQUIRED

6- LEFT SIDE PANEL	x1
7- SHELF	x1

HARDWARE REQUIRED

A		01
F		02

TOOLS REQUIRED

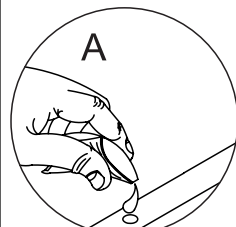
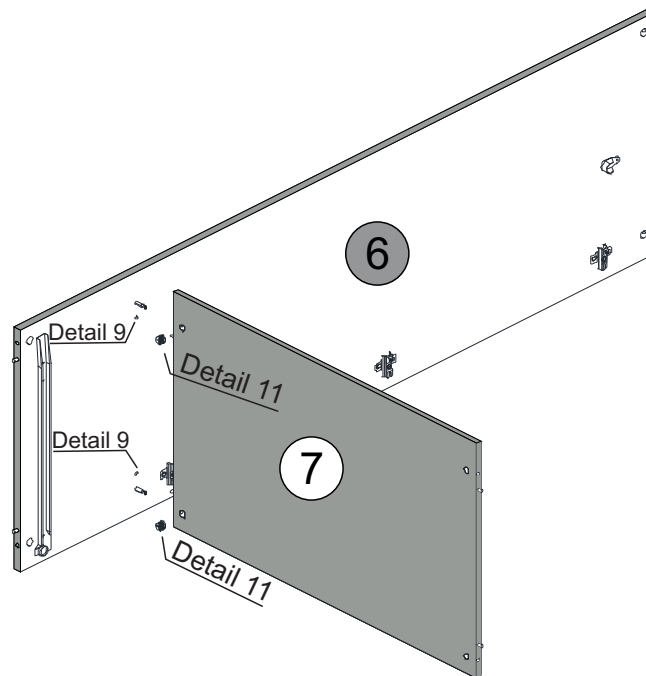
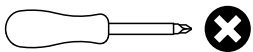

Detail 9

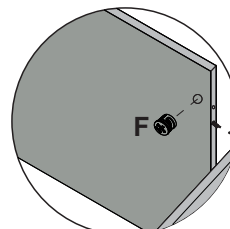

Detail 11

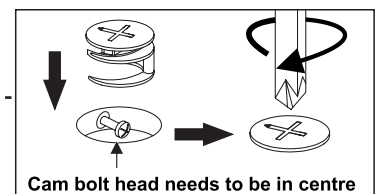

STEP 17

PARTS REQUIRED

8- RIGHT SIDE PANEL x1

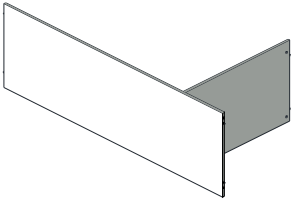

HARDWARE REQUIRED

A  01

F  Ø12mm 02

TOOLS REQUIRED

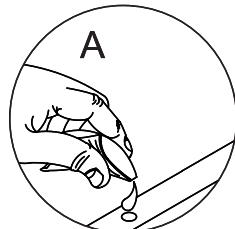
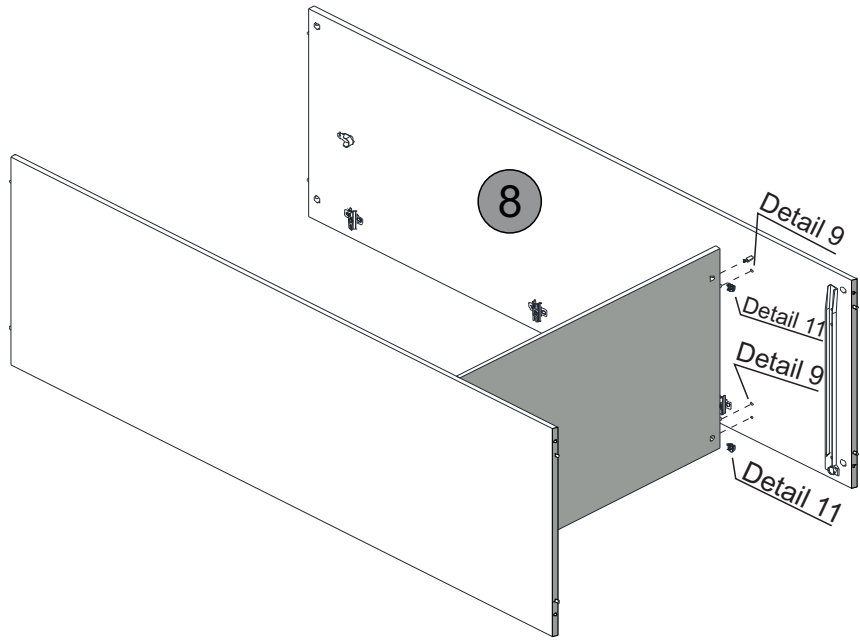
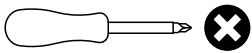

Detail 9

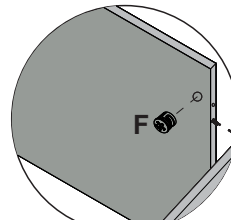

Detail 11

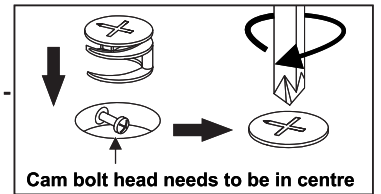

STEP 18

PARTS REQUIRED

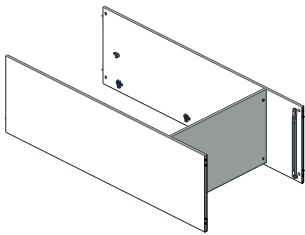

HARDWARE REQUIRED

A  01

O  04

TOOLS REQUIRED

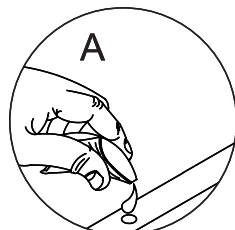
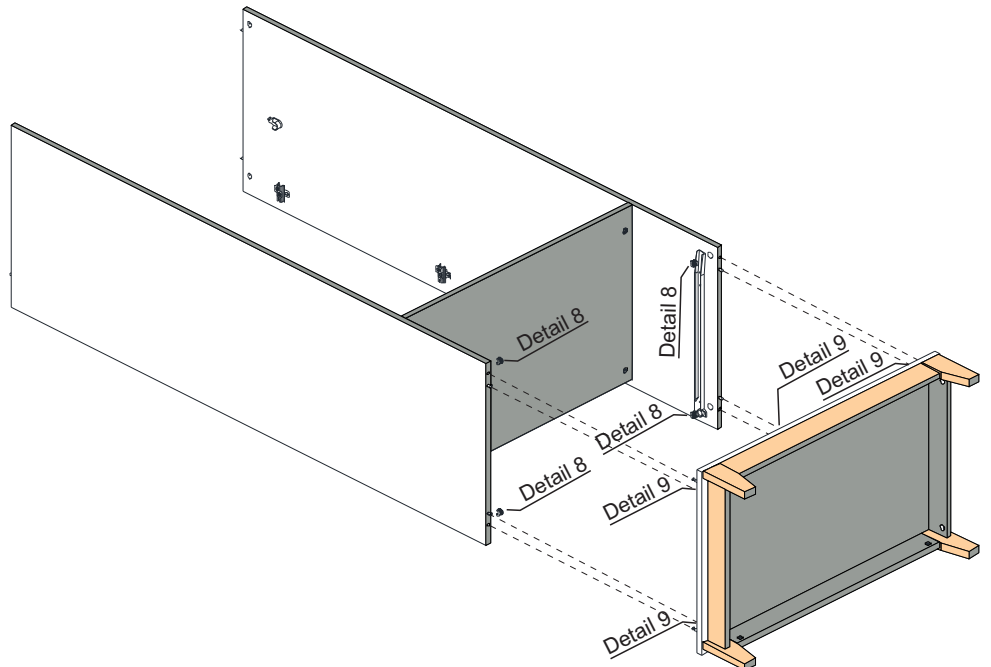
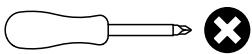

Detail 9

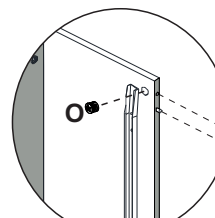

Detail 8

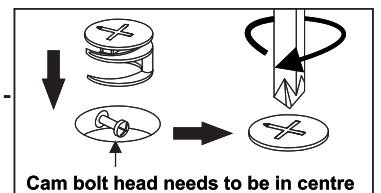

STEP 19

PARTS REQUIRED

9- TOP PANEL x1

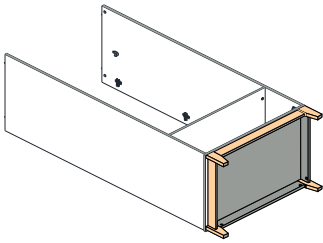

HARDWARE REQUIRED

A  01

O  04

J  04

TOOLS REQUIRED

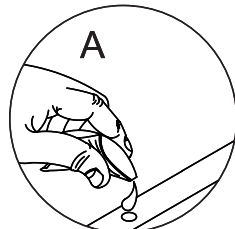
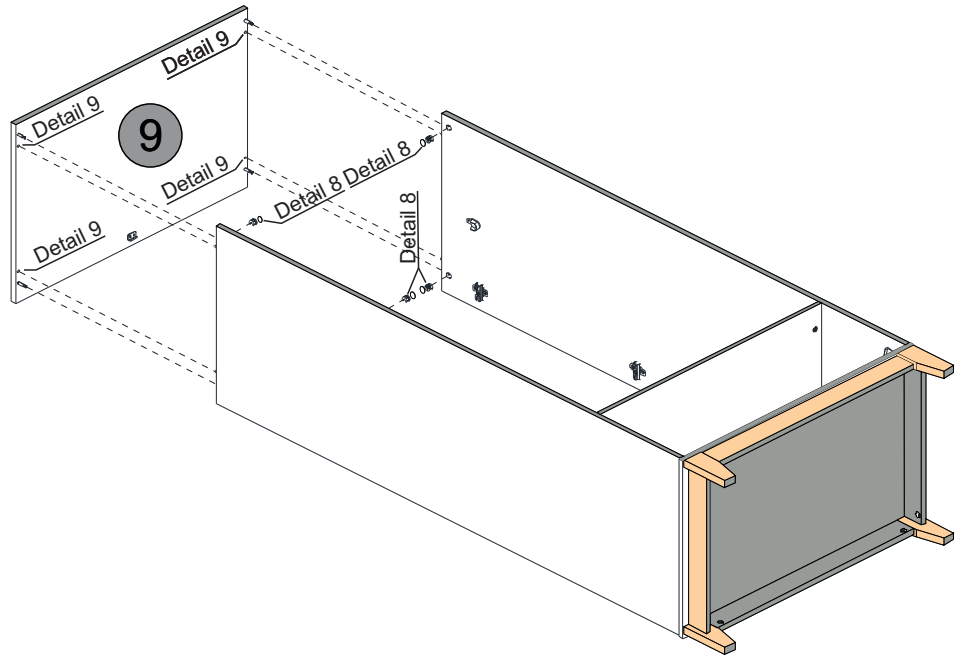
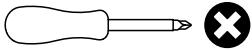

Detail 9

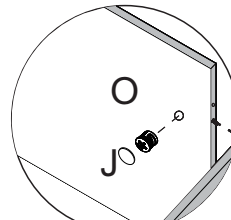

Detail 8

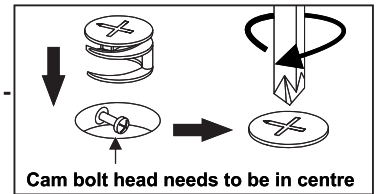

STEP 20

PARTS REQUIRED

10- BACK PANEL x2

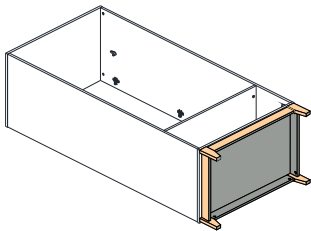

HARDWARE REQUIRED

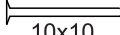
E  10x10 32

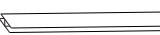
W  01

TOOLS REQUIRED

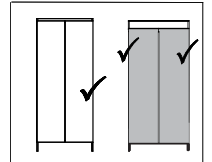
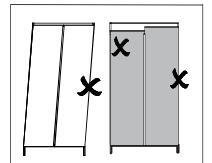
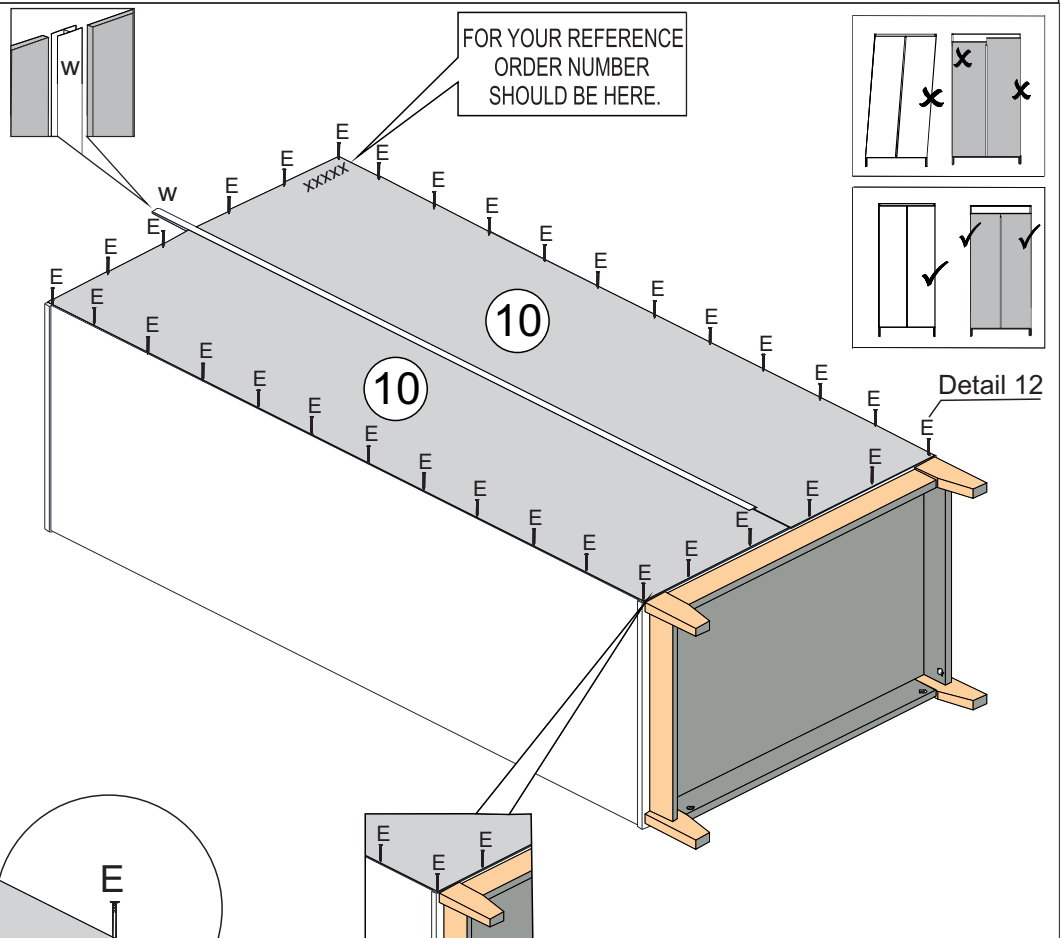
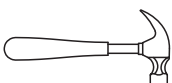

Detail 12

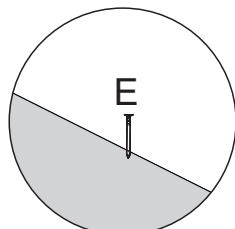

Detail 12

STEP 21

PARTS REQUIRED

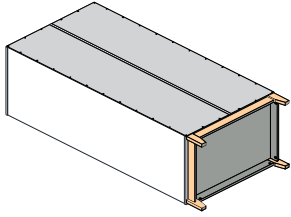

HARDWARE REQUIRED

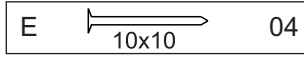

TOOLS REQUIRED

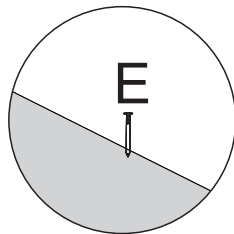
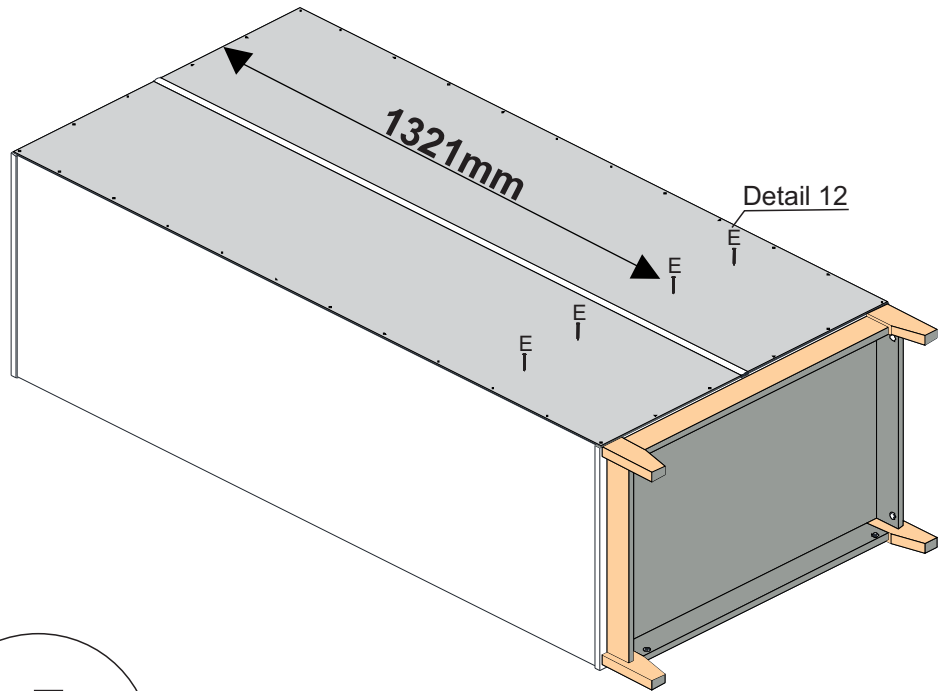
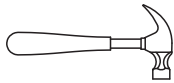

Detail 12

STEP 22

PARTS REQUIRED

- 11- DRAWER SIDES x2
- 12- DRAWER BACK x1
- 14- DRAWER BASE SUPPORT x2

HARDWARE REQUIRED

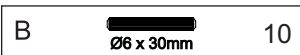
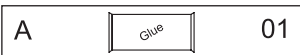

TOOLS REQUIRED

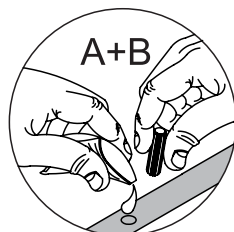
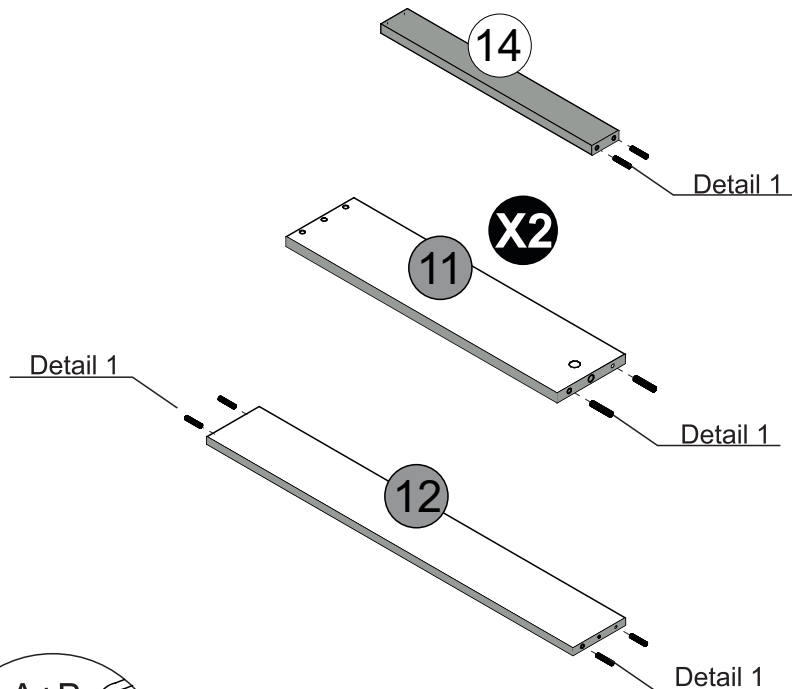
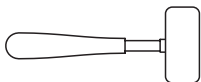

Detail 1

STEP 23

PARTS REQUIRED

15- DRAWER FRONT x1

HARDWARE REQUIRED

G  02

TOOLS REQUIRED

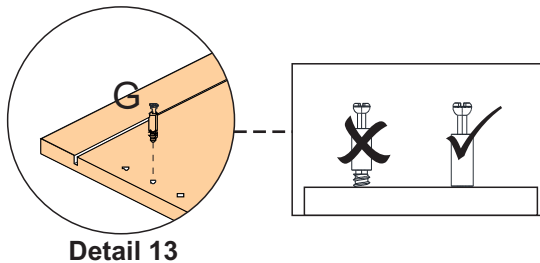
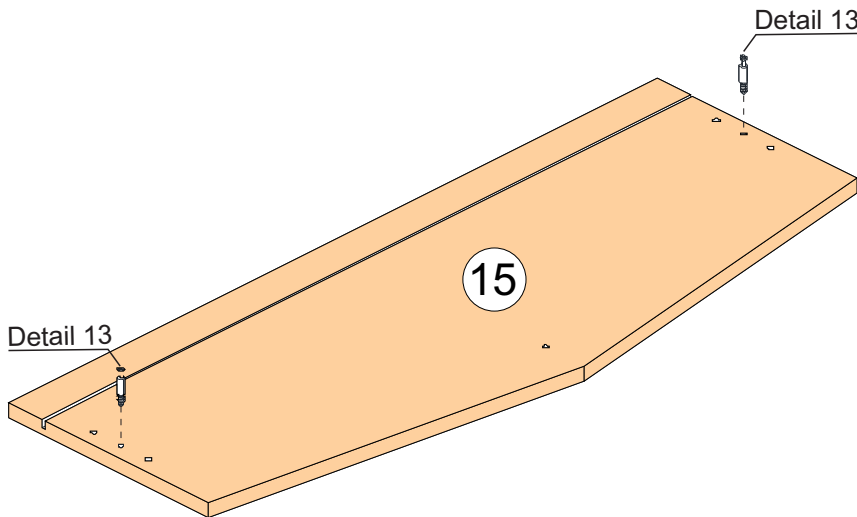

STEP 24

PARTS REQUIRED

11- DRAWER SIDES x2

12- DRAWER BACK x1

HARDWARE REQUIRED

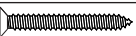
D  Ø4,0 x 40mm 02

TOOLS REQUIRED

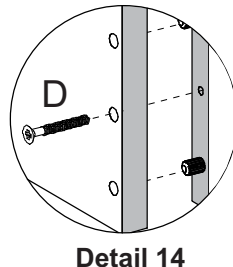
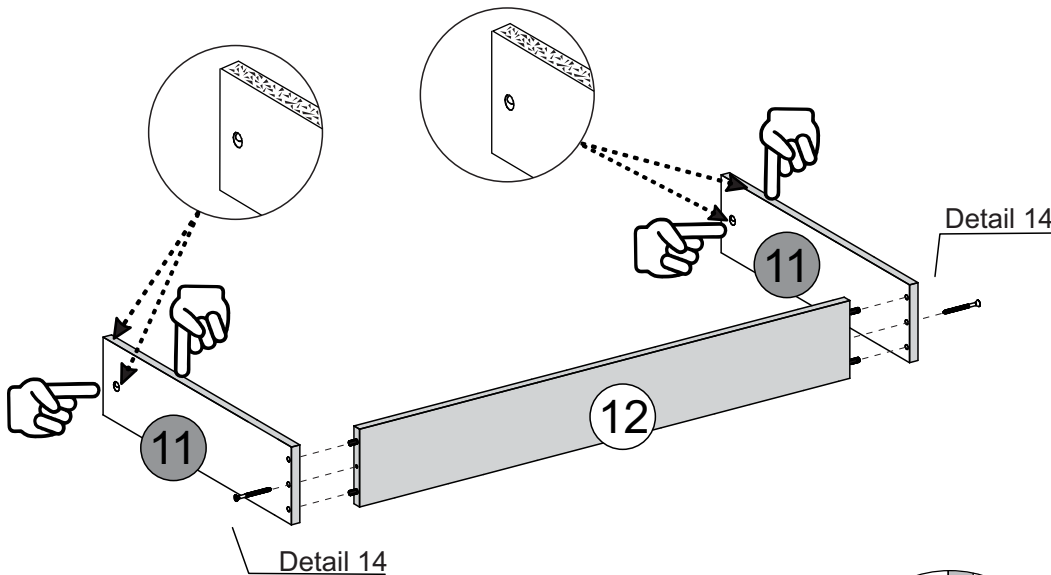
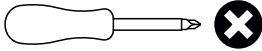

STEP 25

PARTS REQUIRED

15 - DRAWER FRONT x1

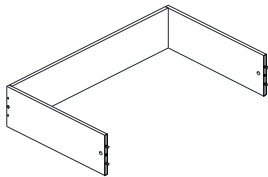

HARDWARE REQUIRED

A 01

F Ø12mm 02

J 02

TOOLS REQUIRED

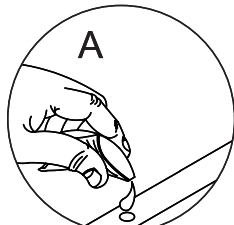
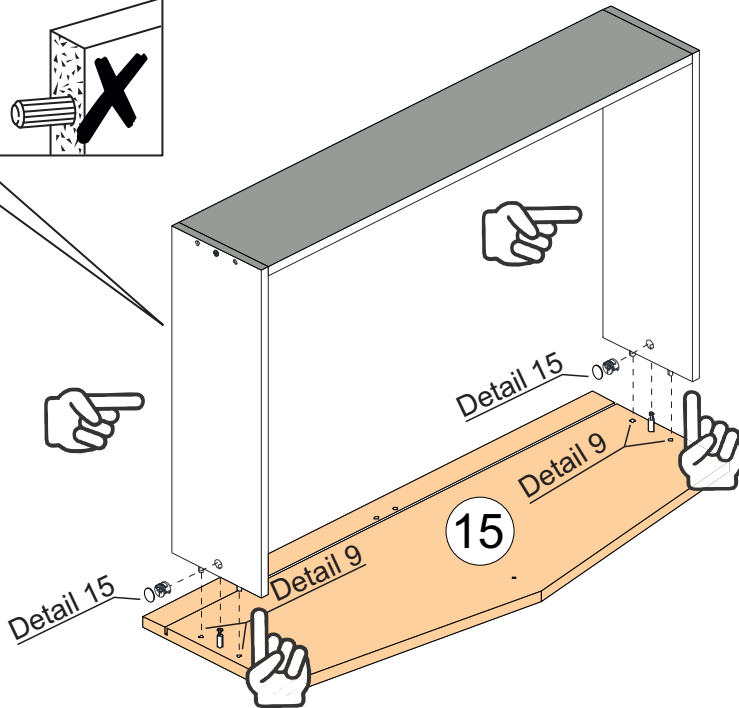
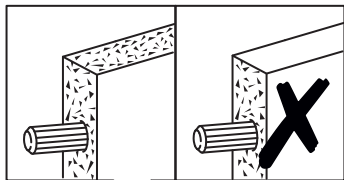

Detail 9

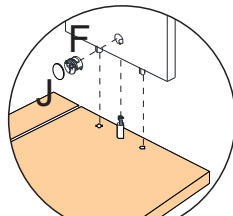

Detail 15

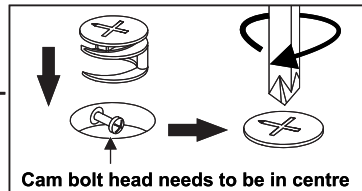

STEP 26

PARTS REQUIRED

13 - DRAWER BASE x1

14 - DRAWER BASE SUPPORT x1

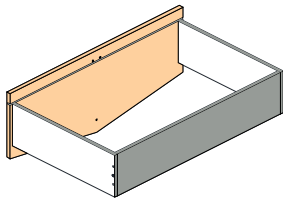

HARDWARE REQUIRED

A 01

E 08

TOOLS REQUIRED

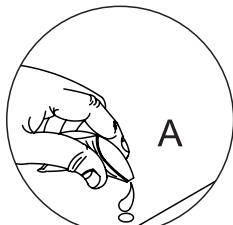
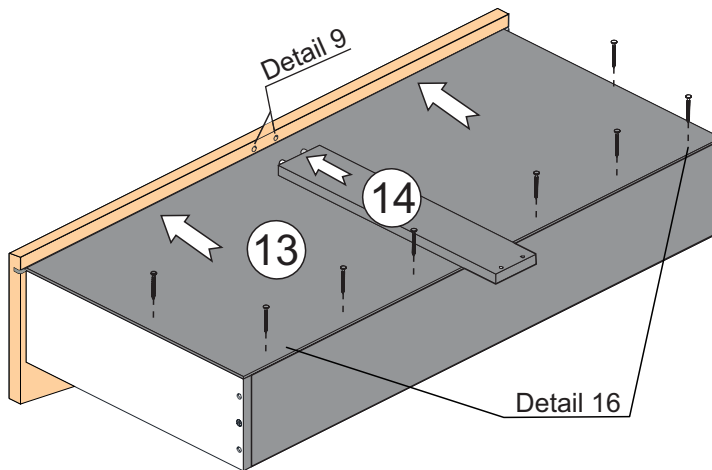
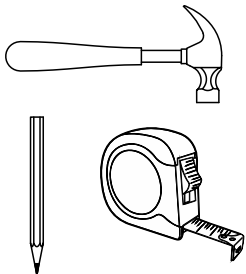

Detail 9

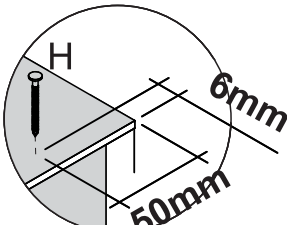

Detail 16

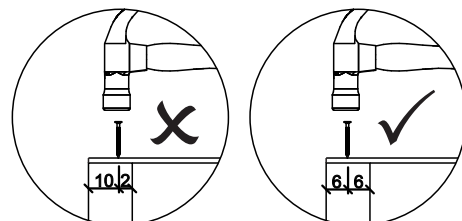
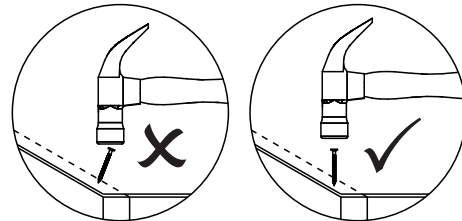

STEP 27

PARTS REQUIRED

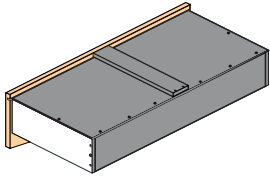

HARDWARE REQUIRED

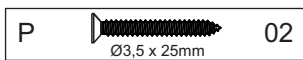
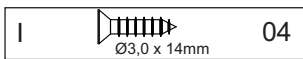
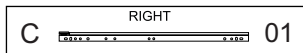
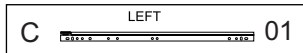

TOOLS REQUIRED

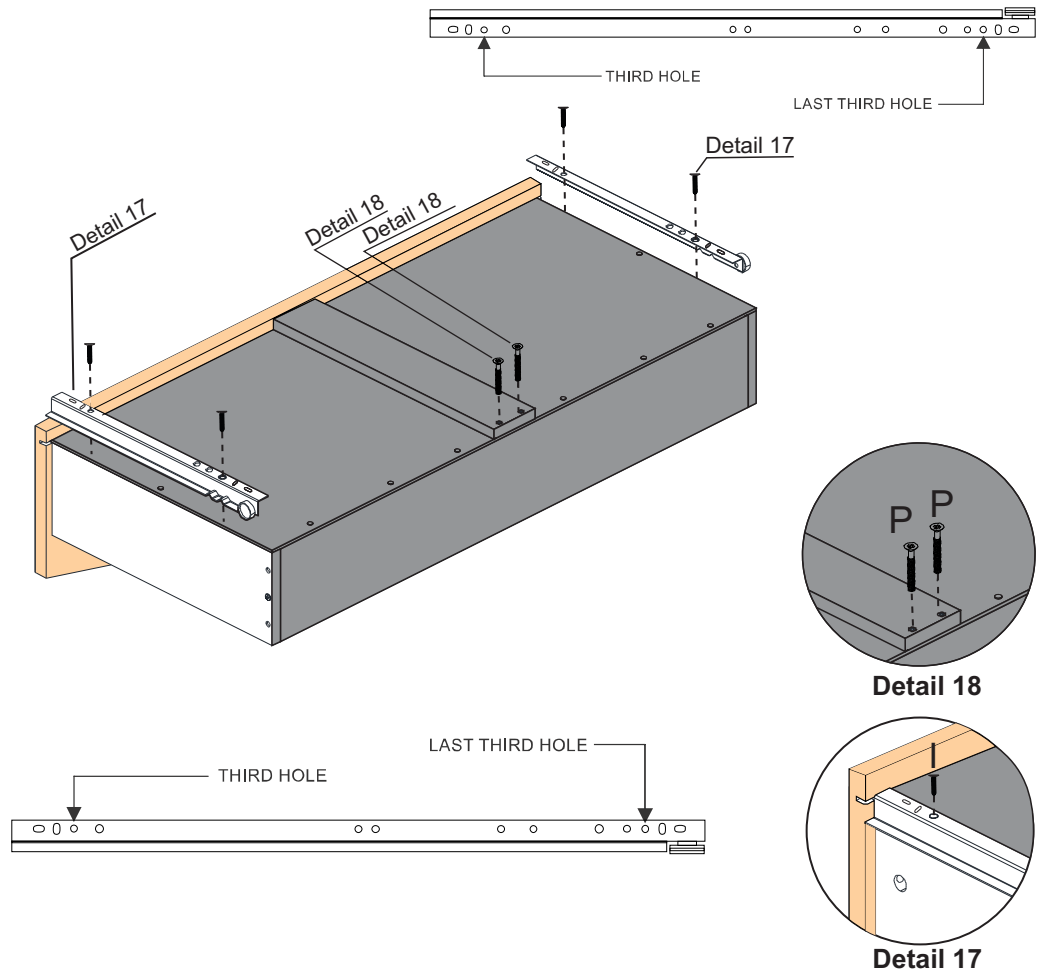
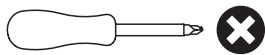

STEP 28

PARTS REQUIRED

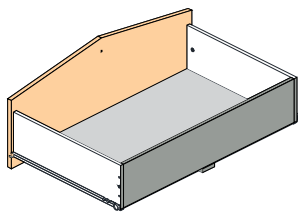

HARDWARE REQUIRED

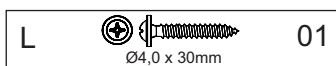
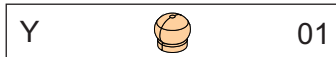

TOOLS REQUIRED

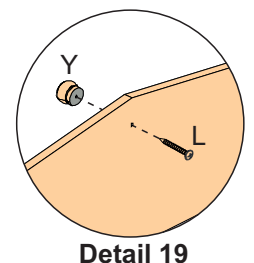
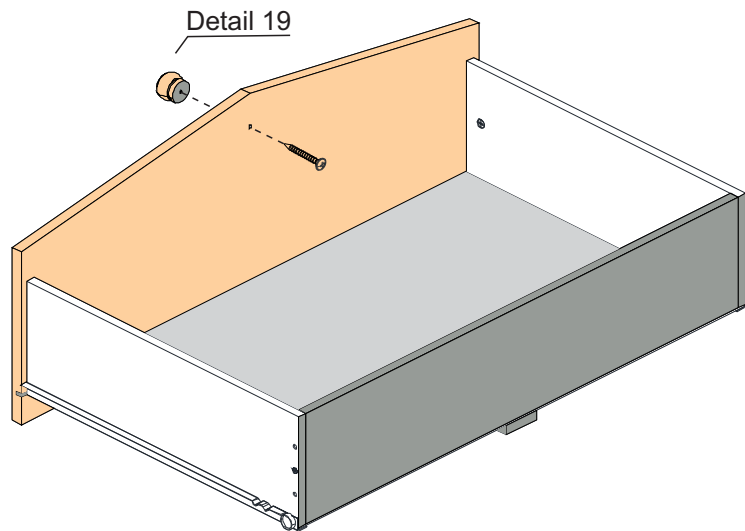
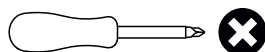

Detail 19

STEP 29

PARTS REQUIRED

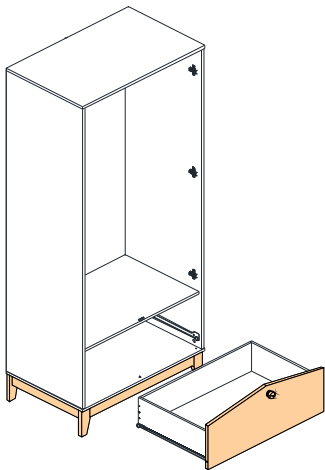

HARDWARE REQUIRED

TOOLS REQUIRED

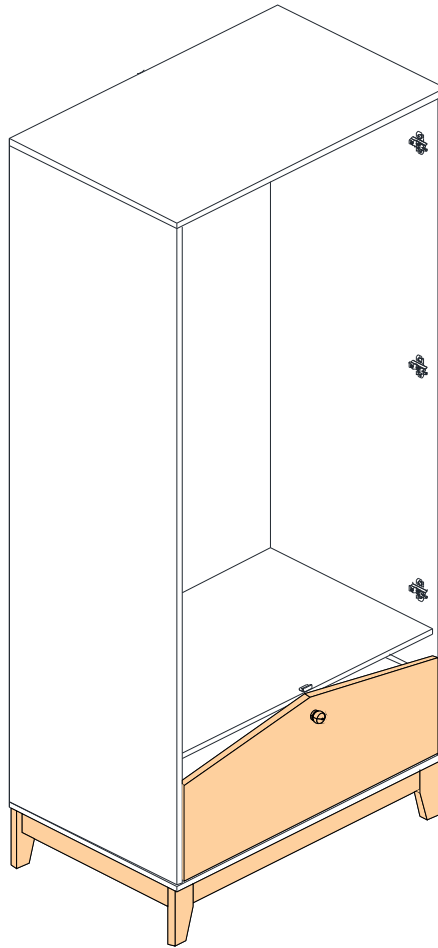

STEP 30

PARTS REQUIRED

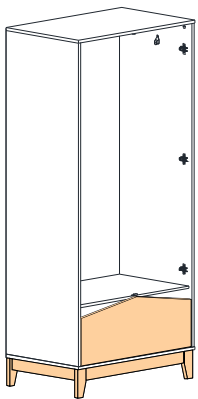

HARDWARE REQUIRED

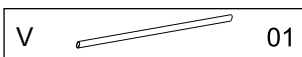

TOOLS REQUIRED

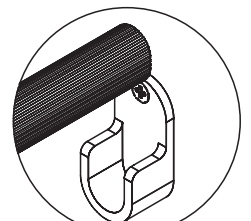
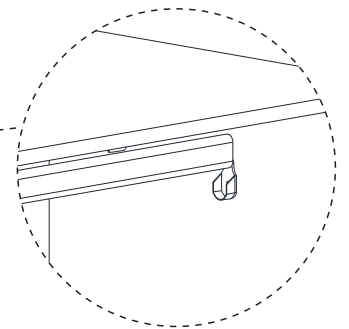
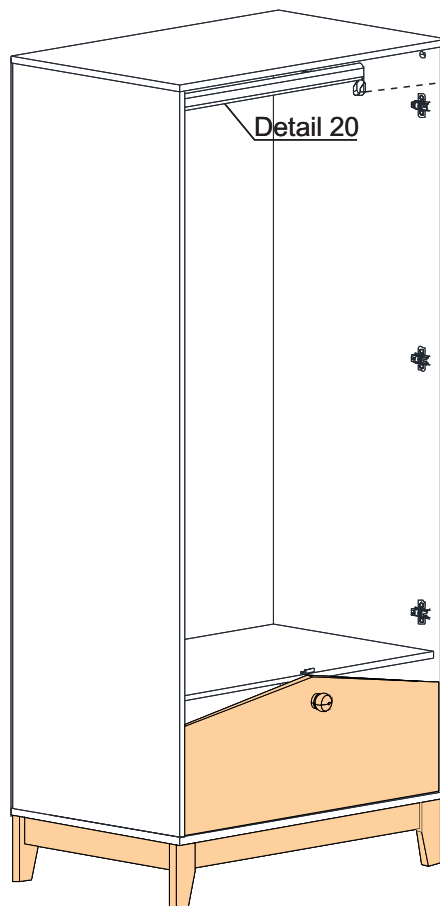



Detail 20

STEP 31

PARTS REQUIRED

16- LEFT DOOR	x1
17- RIGHT DOOR	x1

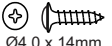
HARDWARE REQUIRED

M	 12 Ø4,0 x 14mm
R	 06

TOOLS REQUIRED

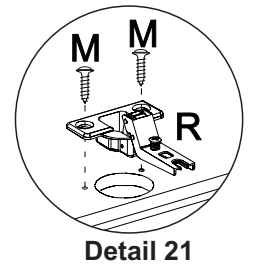
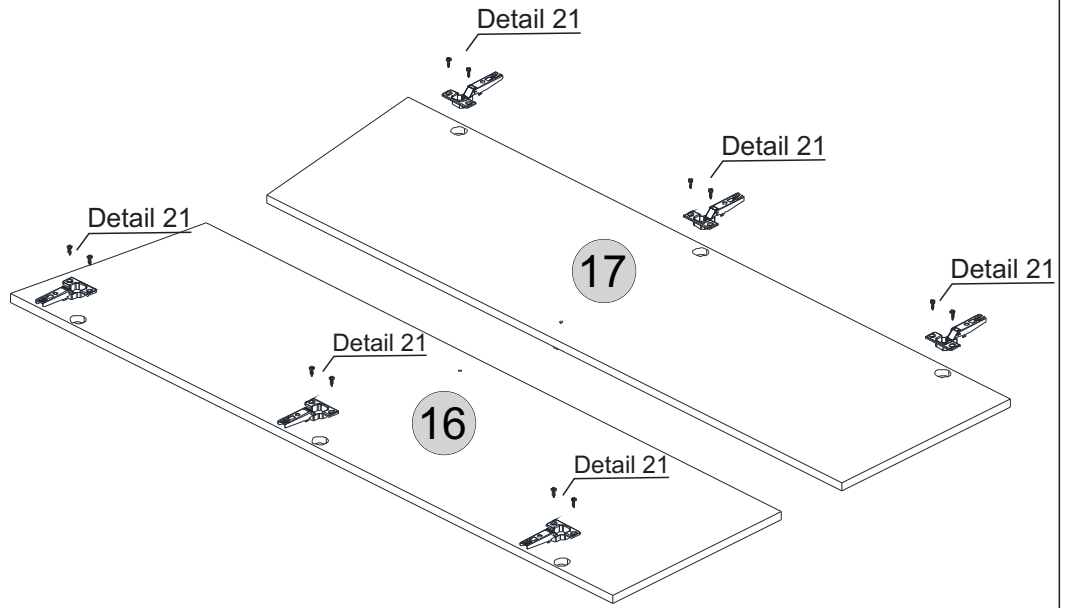
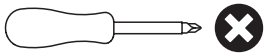



STEP 32

PARTS REQUIRED

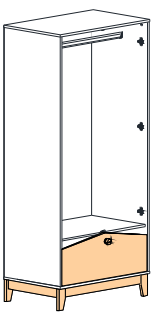
16- LEFT DOOR	x1
17- RIGHT DOOR	x1

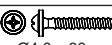

HARDWARE REQUIRED

L	 02 Ø4,0 x 30mm
Y	 02

TOOLS REQUIRED

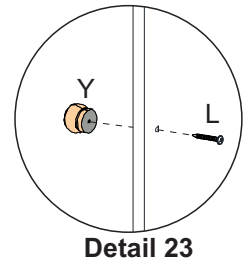
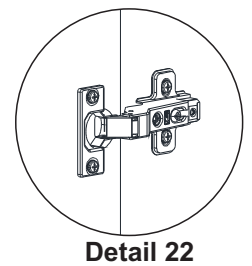
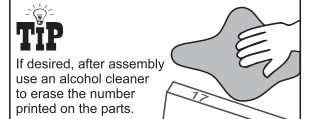
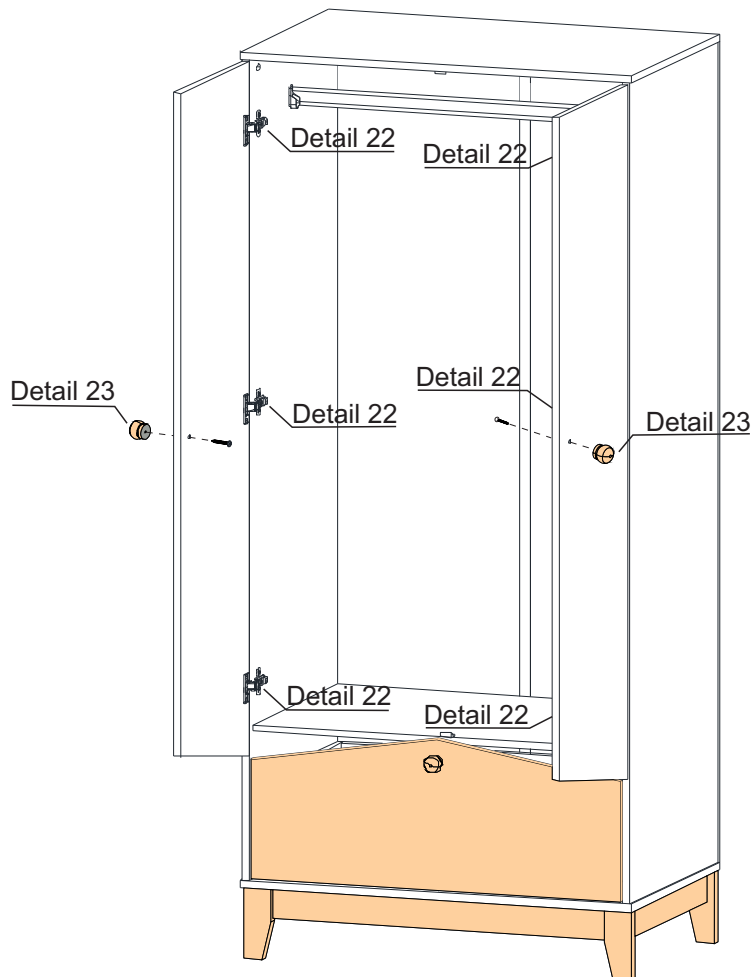
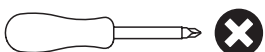

STEP 33

PARTS REQUIRED

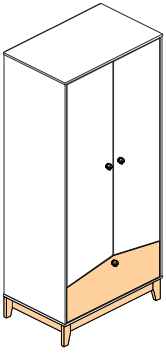

HARDWARE REQUIRED

K  01

TOOLS REQUIRED

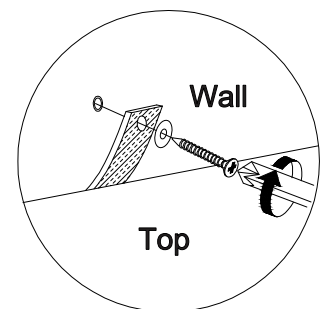
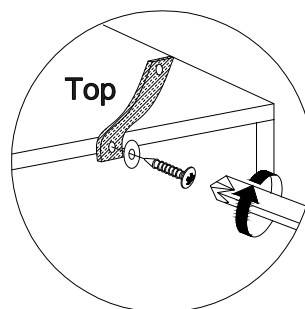
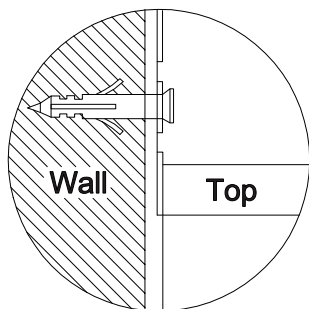
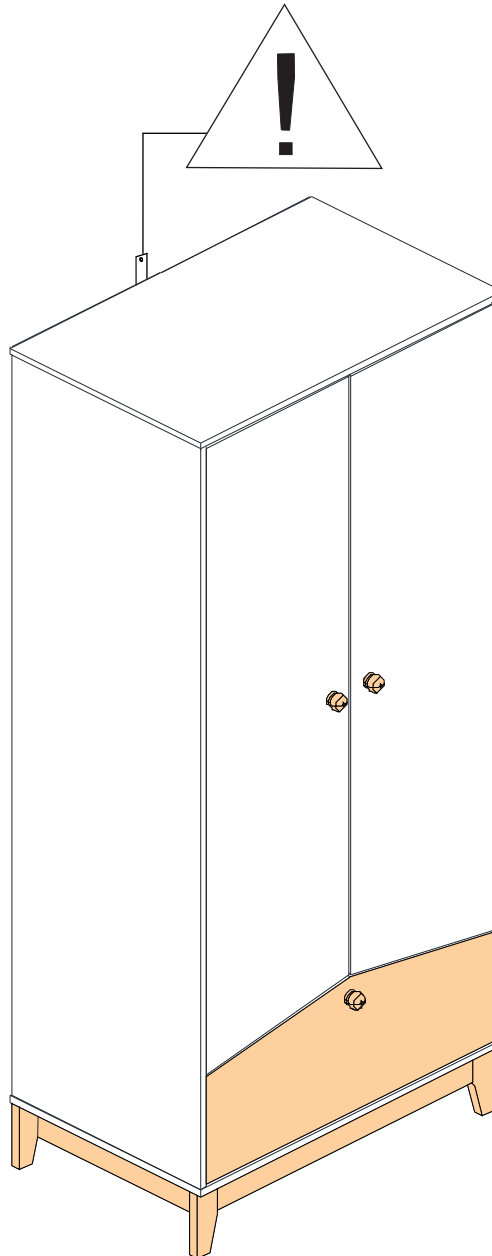
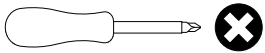

WARNING

Serious or fatal injuries can occur from furniture tipping over. To prevent the furniture from tipping over we recommend that it is permanently fixed to the wall.

Wall fixings are not supplied with this product as different wall materials require different types of fixing devices. Please make sure you use fixings suitable for the walls in your home.

CODY 2+2 DRAWER CHEST ASSEMBLY INSTRUCTIONS WHITE/PINE EFFECT

XXXXXX

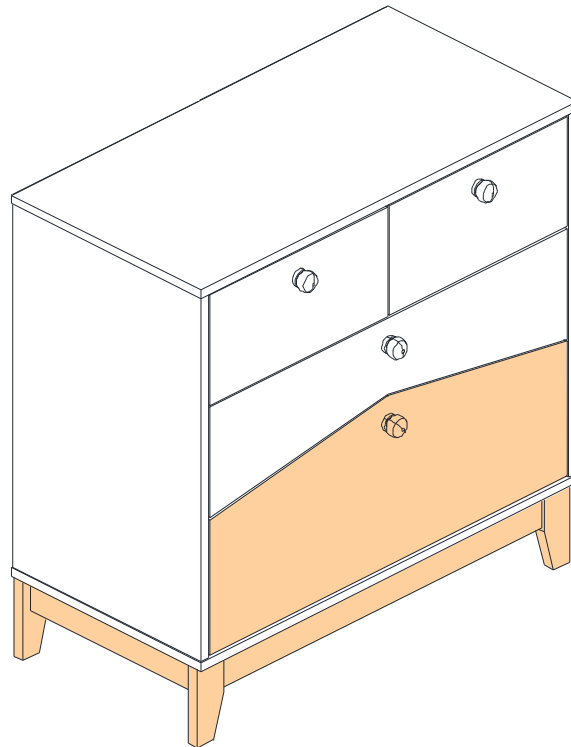

IMPORTANT FOR DOMESTIC USE ONLY PLEASE READ BEFORE YOU CONTINUE FURTHER CARE AND MAINTENANCE

After unpacking this product please keep the original packaging in case it needs to be returned for any reason.

- Please ensure all fittings and parts are present before commencing with assembly.
- Never drag or push products as this could cause damage to the joints making it inferior.
- We strongly recommend that you keep children away from your work area.
- We recommend that you lay a blanket or sheet on the floor to avoid damage to both your floor and the product.
- Assemble this product as close to its final position as possible.
- Do not place this product next to a radiator or in direct sunlight.
- Do not drag or push items across your high gloss furniture as this may cause the surface to scratch
- Wood is a natural product and may expand if subjected to damp and may shrink or crack if subjected to heat. Therefore it is recommended that room temperature is maintained, with no sudden temperature fluctuations.
- Make sure any spillage is wiped off immediately.
- Do not place hot or chilled items directly on to the surface, use a place mat or marking will occur.
- For general cleaning use a soft cotton or micro fibre cloth, and do not use detergents of any kind.
- From time to time it may be necessary to tighten fittings, regular inspections should be carried out.
- Do not place on a wet or damp floor as staining may occur to your floor.



* Use of power tools to assemble this product will invalidate any claim and could damage this product making it unsafe!!!
* Please assemble on a clean soft surface to avoid damage.



* Please check contents and read the instructions before commencing assembly.
* Assemble this product following the enclosed instructions carefully.
* Please take care to avoid damaging parts during assembly.

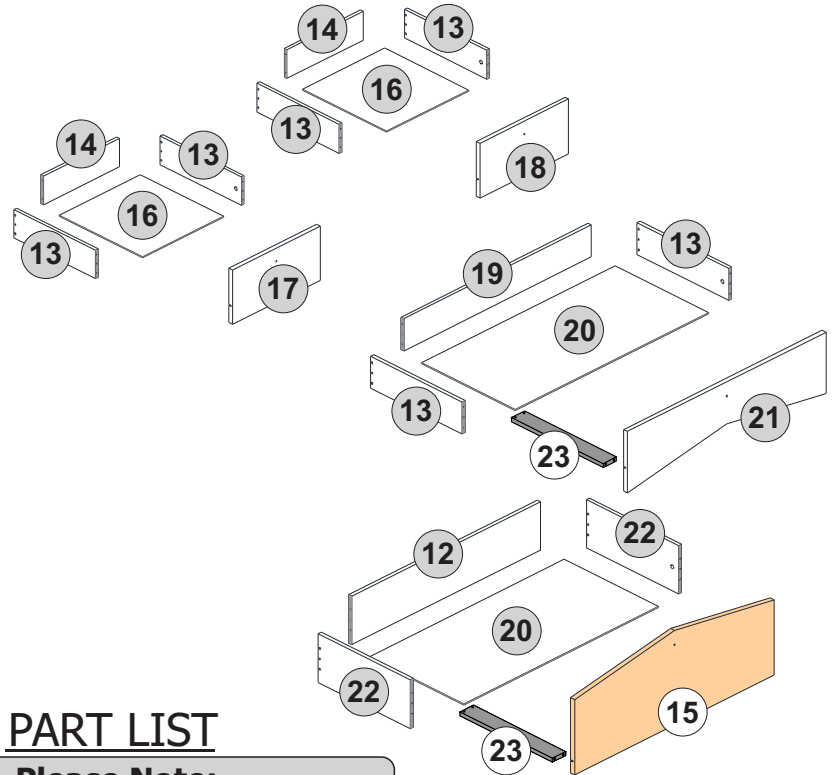
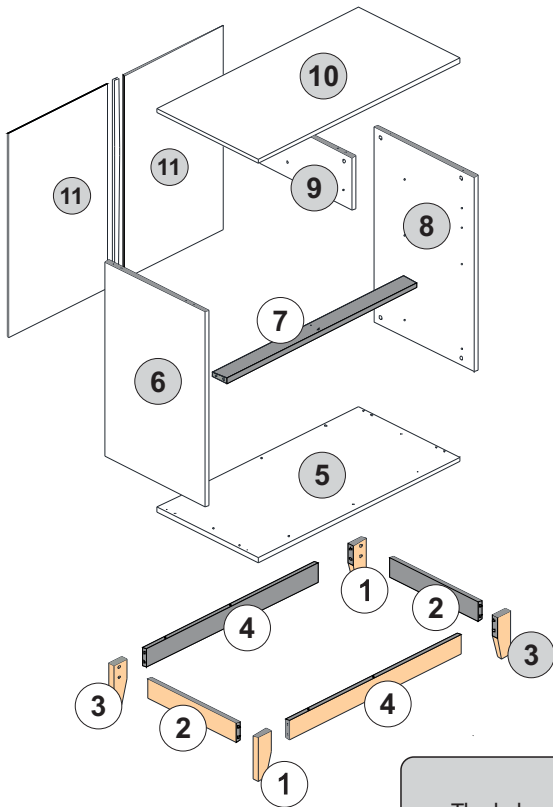















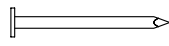

PART LIST

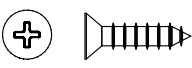
Please Note:

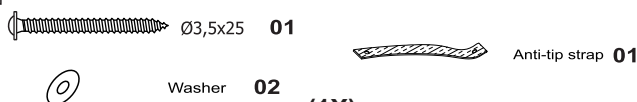
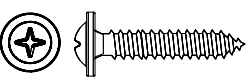
The below parts have all been stamped with the part number/color to help identify them during assembly.

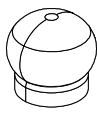
Part Number	Part Code	Part Description	Quantity	Carton
1	S100-102-162-DV1-01	Left Leg	2	1/1
2	S100-102-162-DV1-02	Leg Support Left & Right	2	1/1
3	S100-102-162-DV1-03	Right Leg	2	1/1
4	S100-102-162-DV1-04	Leg Support Front & Back	2	1/1
5	S100-102-162-DV1-05	Base Panel	1	1/1
6	S100-102-162-DV1-06	Left Side Panel	1	1/1
7	S100-102-162-DV1-07	Centre Support	1	1/1
8	S100-102-162-DV1-08	Right Side panel	1	1/1
9	S100-102-162-DV1-09	Dividing Panel	1	1/1
10	S100-102-162-DV1-10	Top Panel	1	1/1
11	S100-102-162-DV1-11	Back Panel	2	1/1
12	S100-102-162-DV1-12	Drawer Back (Large)	1	1/1
13	S100-102-162-DV1-13	Drawer Sides	6	1/1
14	S100-102-162-DV1-14	Drawer Back (Small)	2	1/1
15	S100-102-162-DV1-15	Drawer Front Pine (Large)	1	1/1
16	S100-102-162-DV1-16	Drawer Base	2	1/1
17	S100-102-162-DV1-17	Drawer Front (Left)	1	1/1
18	S100-102-162-DV1-18	Drawer Front (Right)	1	1/1
19	S100-102-162-DV1-19	Drawer Back (Medium)	1	1/1
20	S100-102-162-DV1-20	Drawer Base(Large)	2	1/1
21	S100-102-162-DV1-21	Centre Drawer Front	1	1/1
22	S100-102-162-DV1-22	Drawer Sides (Large)	2	1/1
23	S100-102-162-DV1-23	Drawer Base Support	2	1/1

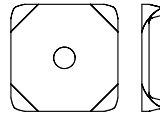
FITTINGS LIST

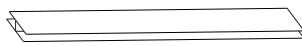
<p>A</p>  <p style="text-align: center;">Glue (3x)</p>	<p>B</p>  <p style="text-align: center;">2/+ Dowel Ø6,0 x 30mm (53x)</p>	<p>C</p>  <p style="text-align: center;">Slide 350mm (4x)</p>	<p>D</p>  <p style="text-align: center;">1/+ Flat Head Screw Ø4,0 x 40mm (14x)</p>
<p>E</p>  <p style="text-align: center;">5/+ Nail 10 x 10 (52x)</p>	<p>F</p>  <p style="text-align: center;">1/+ Cam Nut 12mm (8x)</p>	<p>G</p>  <p style="text-align: center;">1/+ Cam Bolt (28x)</p>	<p>H</p>  <p style="text-align: center;">1/+ Screw Ø 6x8 (16x)</p>
<p>I</p>  <p style="text-align: center;">1/+ Flat Head Screw Ø3,0 x 14mm (16x)</p>	<p>J</p>  <p style="text-align: center;">2/+ Hole Plugs (8x)</p>	<p>K</p>  <p style="text-align: center;">Washer 02 (1X) Ø3,5x25 01 Anti-tip strap 01</p>	
<p>L</p>  <p style="text-align: center;">1/+ Flan Head Screw Ø4,0 x 30mm (4x)</p>	<p>M</p>  <p style="text-align: center;">2/+ Dowel Ø8,0 x 30mm (8x)</p>	<p>N</p>  <p style="text-align: center;">1/+ Cam Nut 15mm (20x)</p>	<p>O</p>  <p style="text-align: center;">Handle(4x)</p>
<p>P</p>  <p style="text-align: center;">1/+ Flat Head Screw Ø3,5 x 25mm (4x)</p>	<p>Q</p>  <p style="text-align: center;">1/+ Back Panel Bracket (4x)</p>	<p>R</p>  <p style="text-align: center;">Flat Head Screw Ø4,0 x 50mm (1x)</p>	<p>S</p>  <p style="text-align: center;">Plastic profile 456mm (1x)</p>

TOOLS REQUIRED

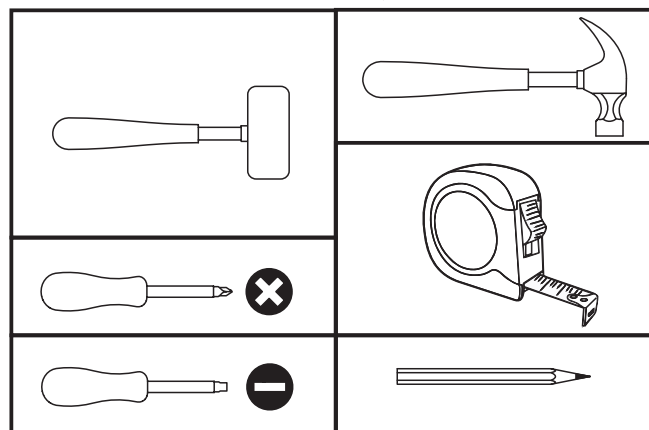

TIPS FOR FITTINGS CAM-LOCKS

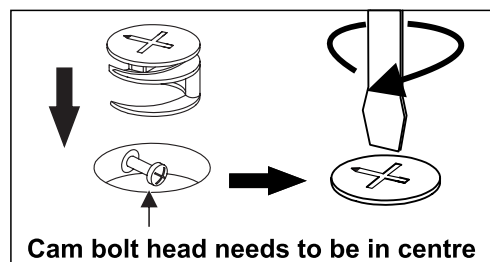
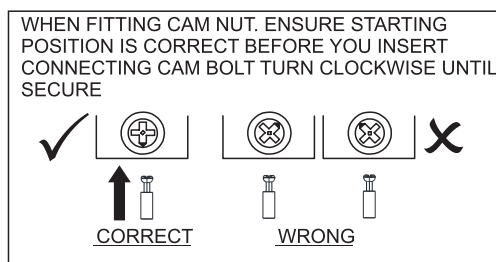

CAMBOLT

Tighten until shoulder in flush with panel. Do not overtighten or undertighten (see example beside)

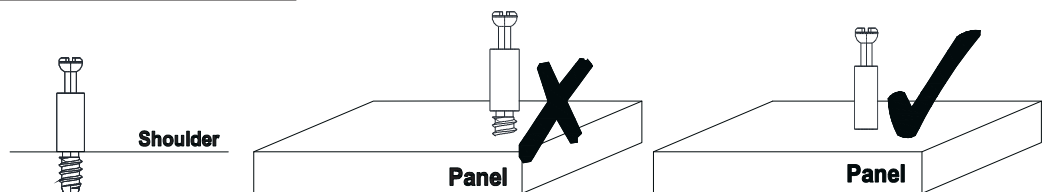

STEP 1

PARTS REQUIRED

1 - LEFT LEG x2

3 - RIGHT LEG x2

HARDWARE REQUIRED

G  08

TOOLS REQUIRED

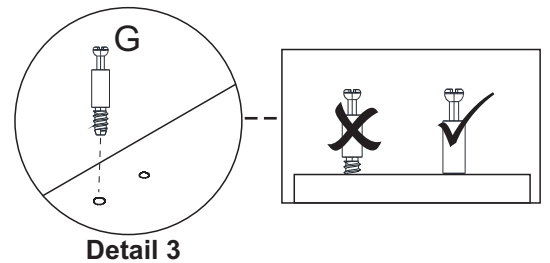
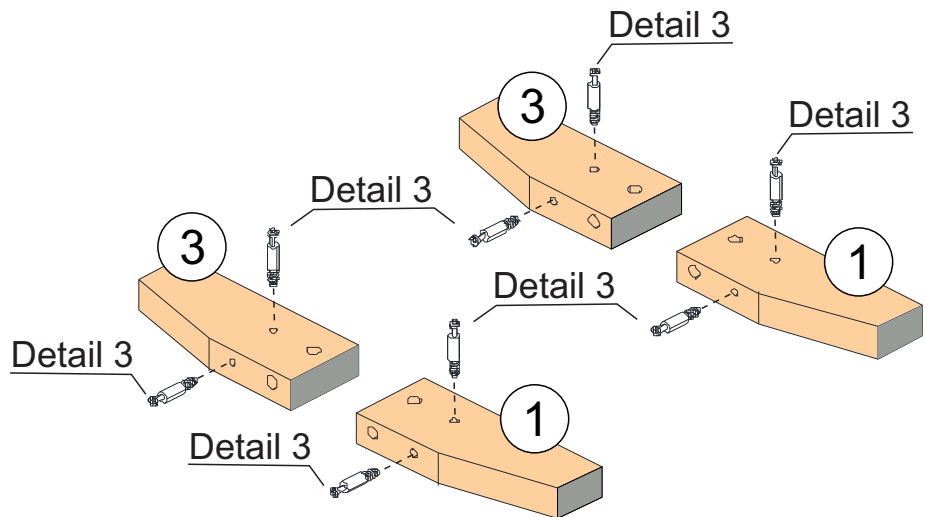
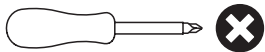

STEP 2

PARTS REQUIRED

2- LEG SUPPORT LEFT+RIGHT x2

4- LEG SUPPORT FRONT+BACK x2

HARDWARE REQUIRED

A  01

B  Ø6 x 30mm 04

M  Ø8 x 30mm 08

TOOLS REQUIRED

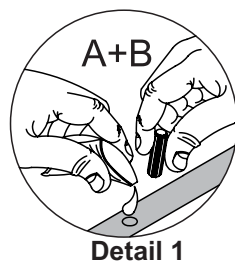
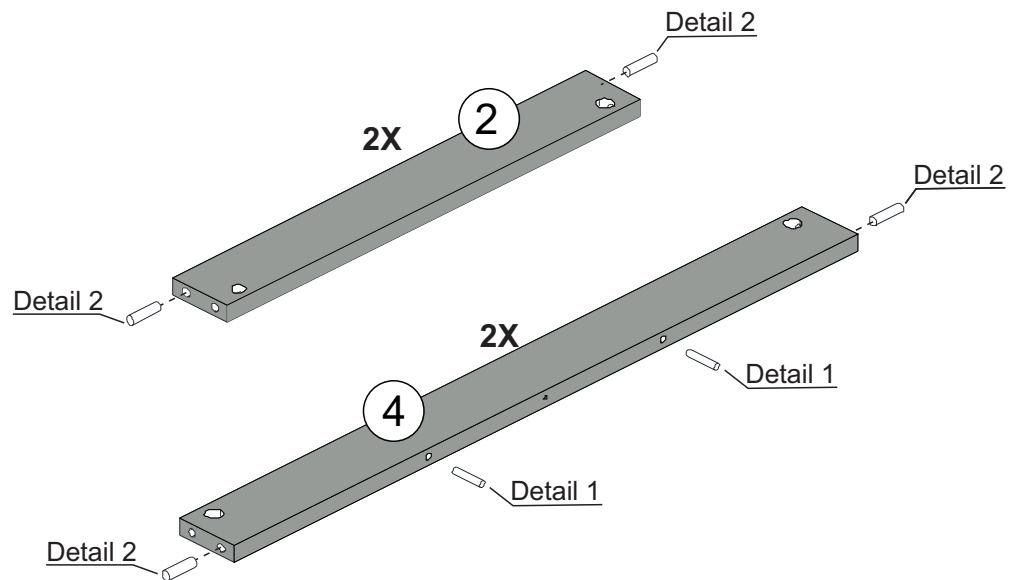
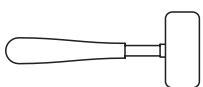

STEP 3

PARTS REQUIRED

7- CENTRE SUPPORT x1

9- DIVIDING PANEL x1

HARDWARE REQUIRED

A  01

B  Ø6 x 30mm 05

TOOLS REQUIRED

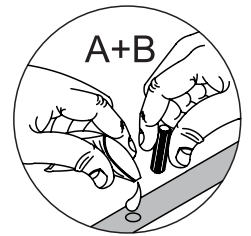
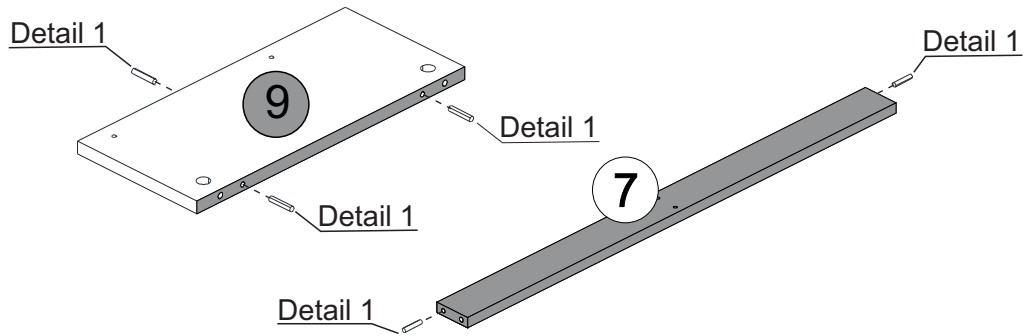
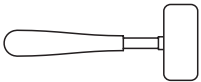

Detail 1

STEP 4

PARTS REQUIRED

9- DIVIDING PANEL x1

HARDWARE REQUIRED

H  Ø6 x 8mm 02

C  Right 350mm 01

TOOLS REQUIRED

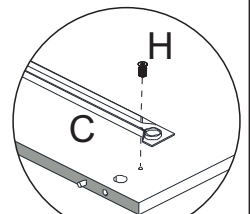
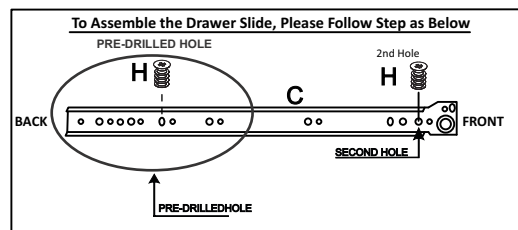
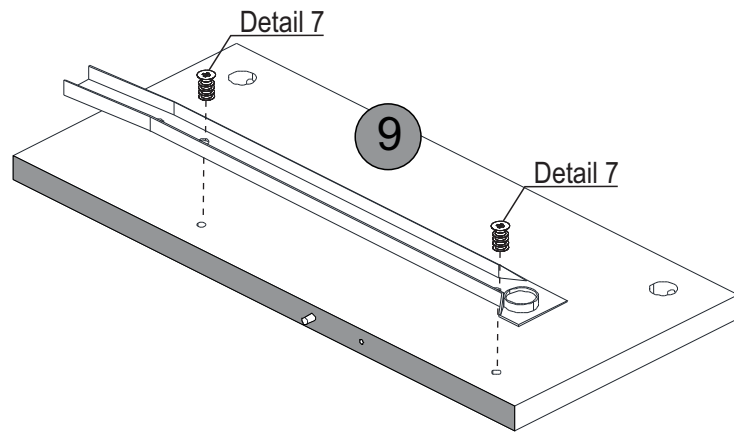

Detail 7

STEP 5

PARTS REQUIRED

9- DIVIDING PANEL x1

HARDWARE REQUIRED

C  Left 01
350mm

H  02
Ø6 x 8mm

TOOLS REQUIRED

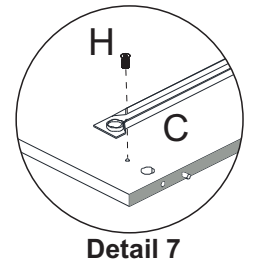
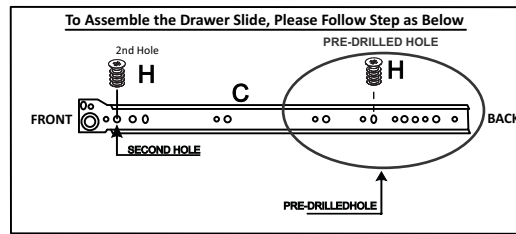
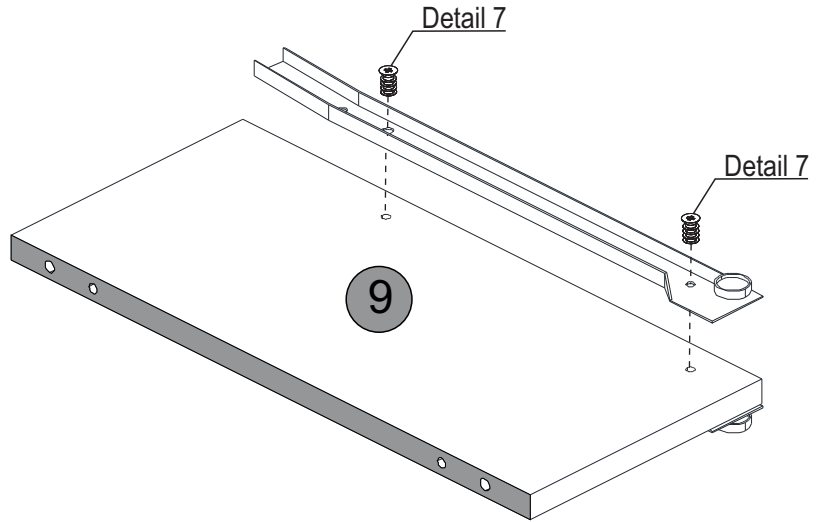

STEP 6

PARTS REQUIRED

10-TOP PANEL x1

HARDWARE REQUIRED

G  06

TOOLS REQUIRED

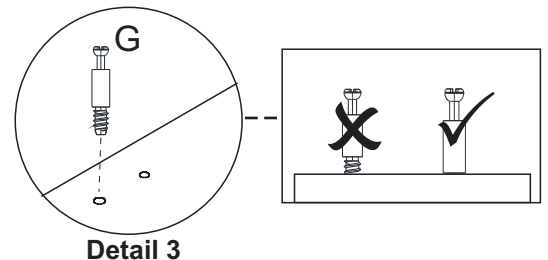
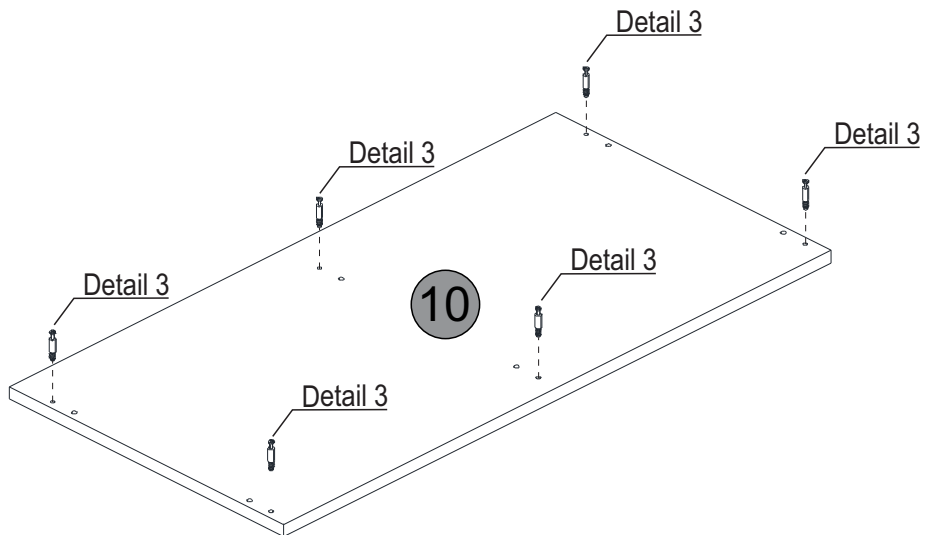

STEP 7

PARTS REQUIRED

6- LEFT SIDE PANEL x1

HARDWARE REQUIRED

A  01

B  04
Ø6 x 30mm

G  01

TOOLS REQUIRED

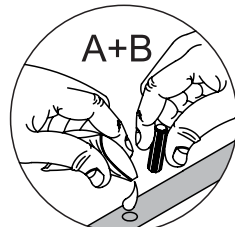
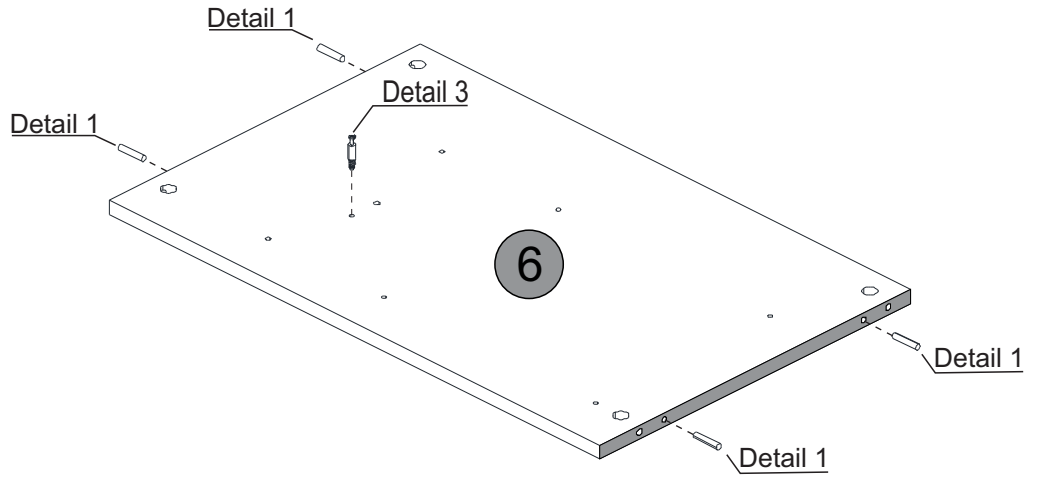
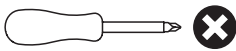
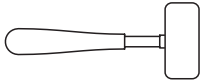

Detail 1

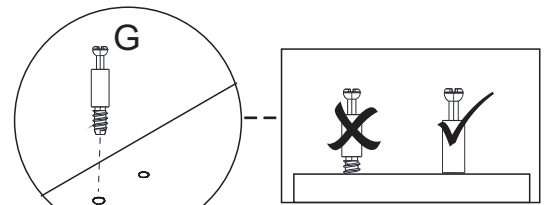

Detail 3

STEP 8

PARTS REQUIRED

6- LEFT SIDE PANEL x1

HARDWARE REQUIRED

C  03
Left
350mm

H  06
Ø6 x 8mm

TOOLS REQUIRED

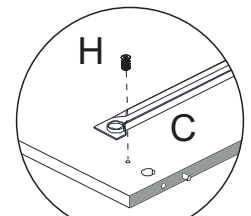
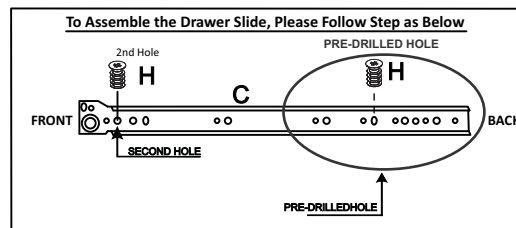
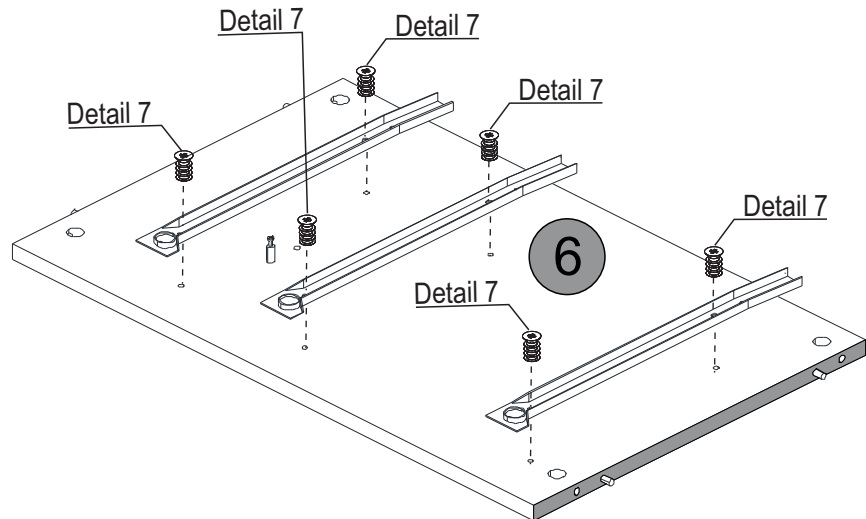

Detail 7

STEP 9

PARTS REQUIRED

8- RIGHT SIDE PANEL x1

HARDWARE REQUIRED

A  01

B  04

G  01

TOOLS REQUIRED

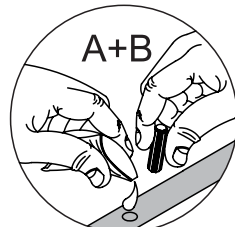
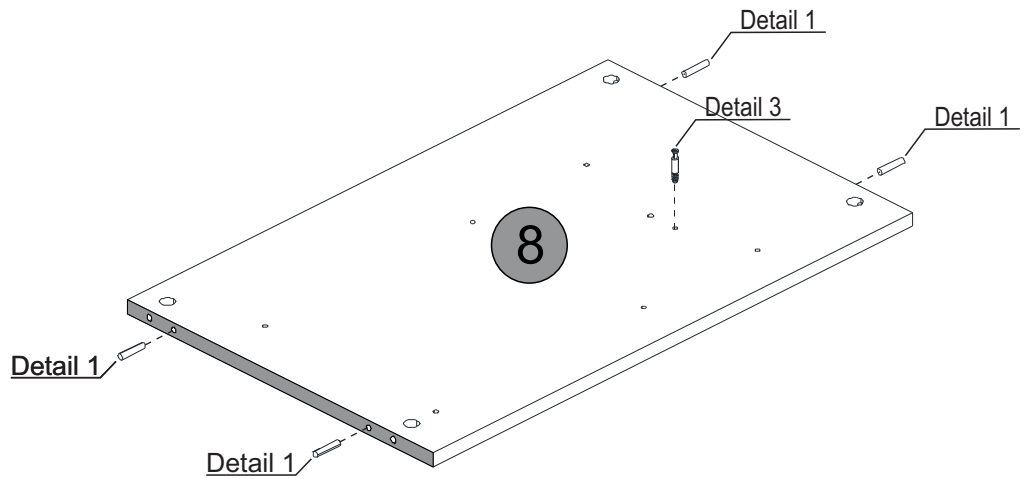
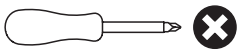
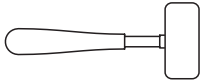

Detail 1

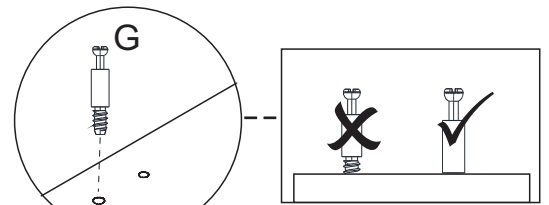

Detail 3

STEP 10

PARTS REQUIRED

8 - RIGHT SIDE PANEL x1

HARDWARE REQUIRED

C  03

H  06

TOOLS REQUIRED

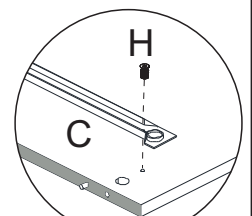
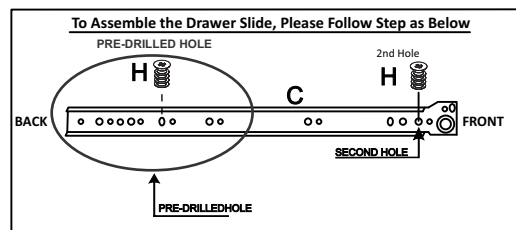
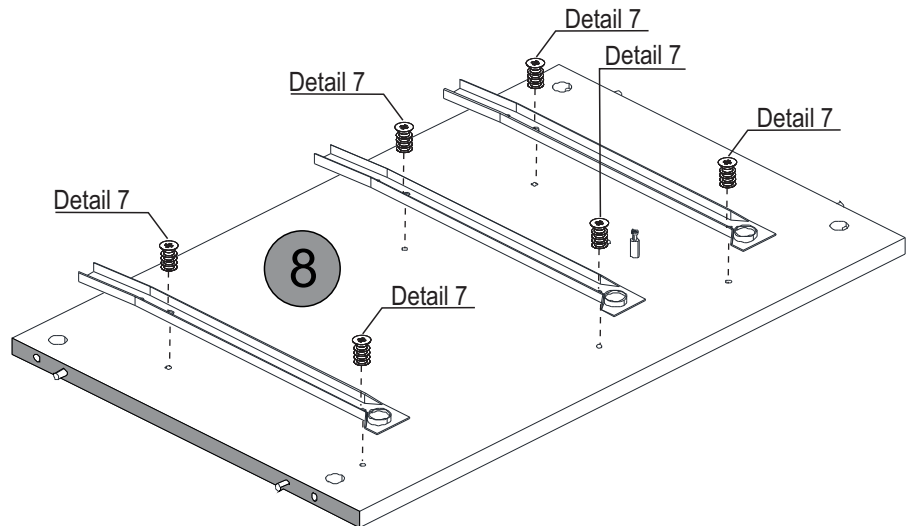



Detail 7

STEP 11

PARTS REQUIRED

1- LEFT LEG	x2
3- RIGHT LEG	x2
4- LEG SUPPORT FRONT & BACK	x2

HARDWARE REQUIRED

A		01
N		04

TOOLS REQUIRED

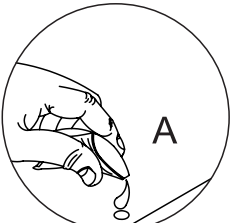
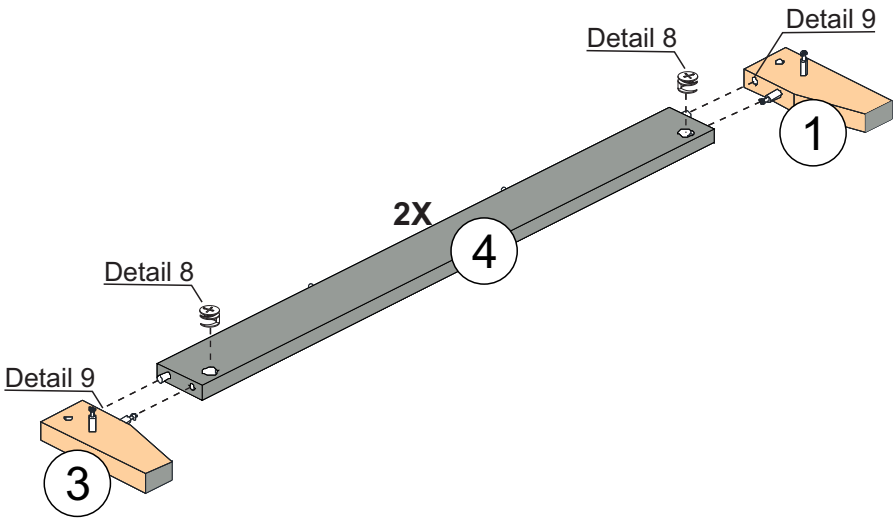
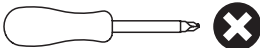

Detail 9

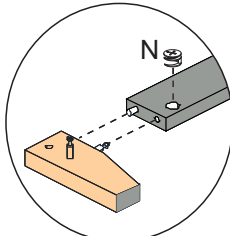

Detail 8

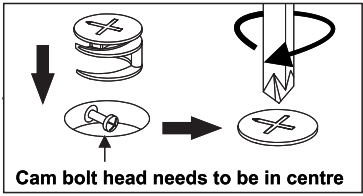



STEP 12

PARTS REQUIRED

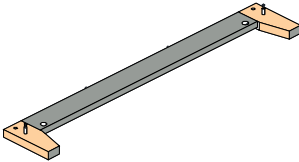
2- LEG SUPPORT LEFT & RIGHT	x2
-----------------------------	----



HARDWARE REQUIRED

A		01
N		02

TOOLS REQUIRED

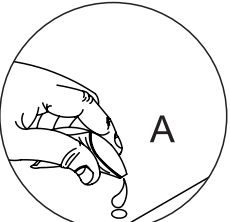
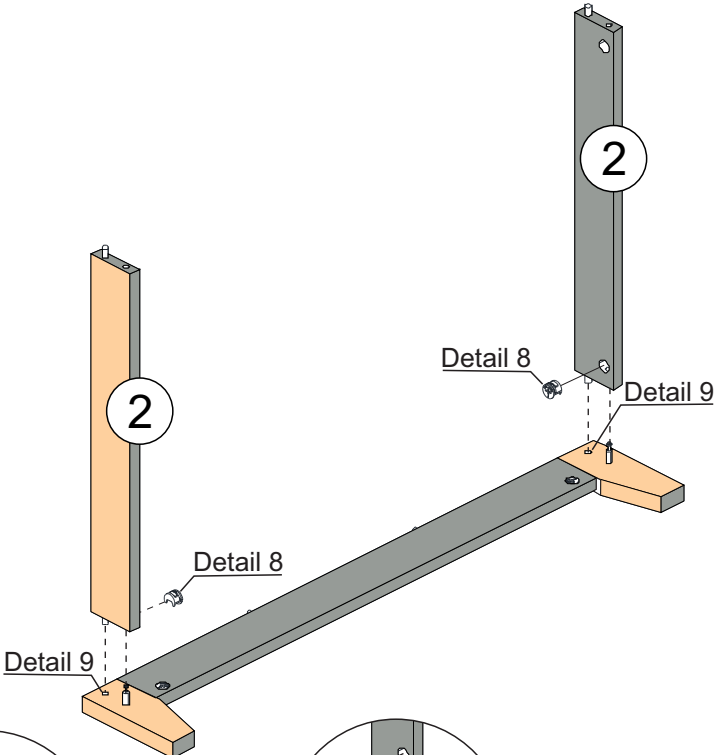
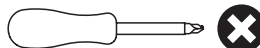

Detail 9

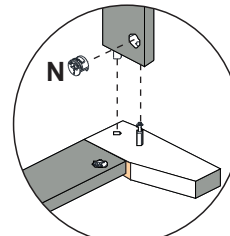

Detail 8

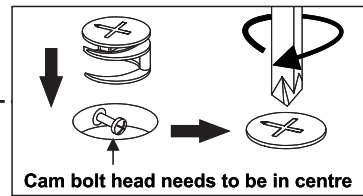

STEP 13

PARTS REQUIRED

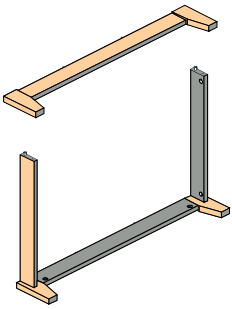

HARDWARE REQUIRED

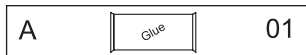

TOOLS REQUIRED

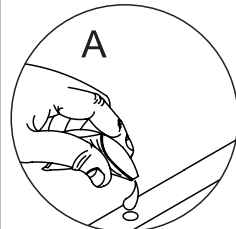
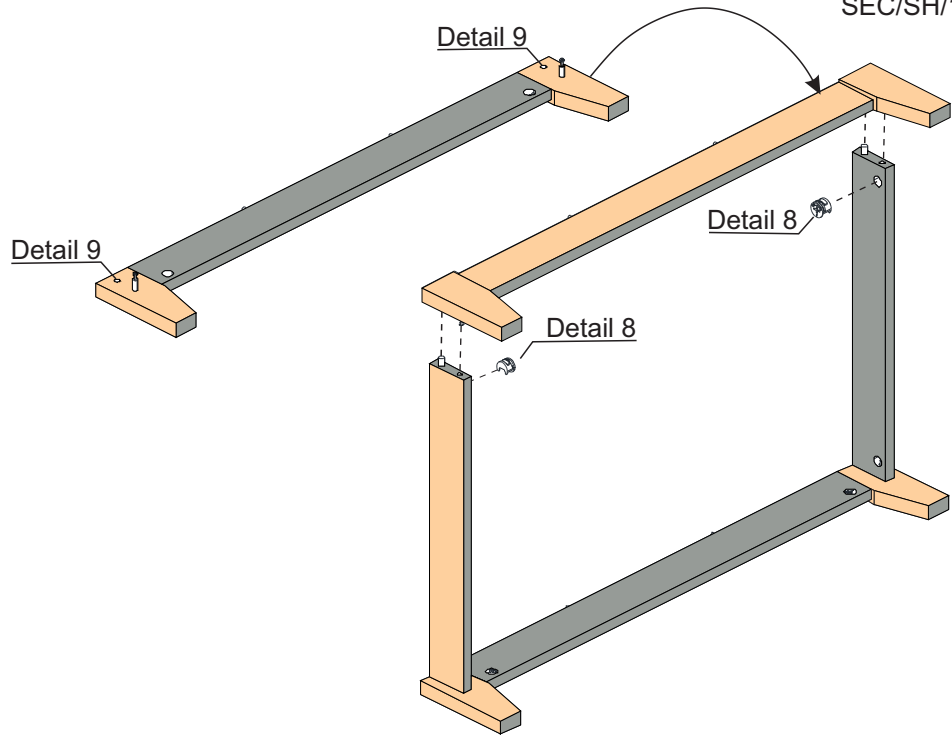
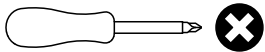

Detail 9

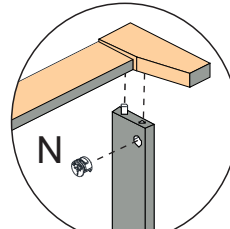

Detail 8

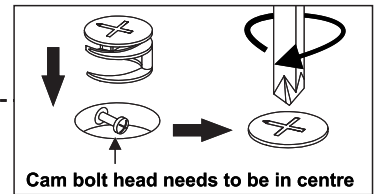

STEP 14

PARTS REQUIRED

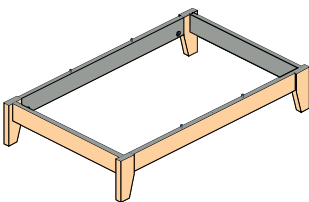

HARDWARE REQUIRED

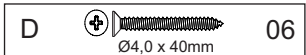
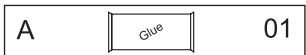

TOOLS REQUIRED

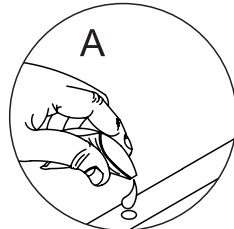
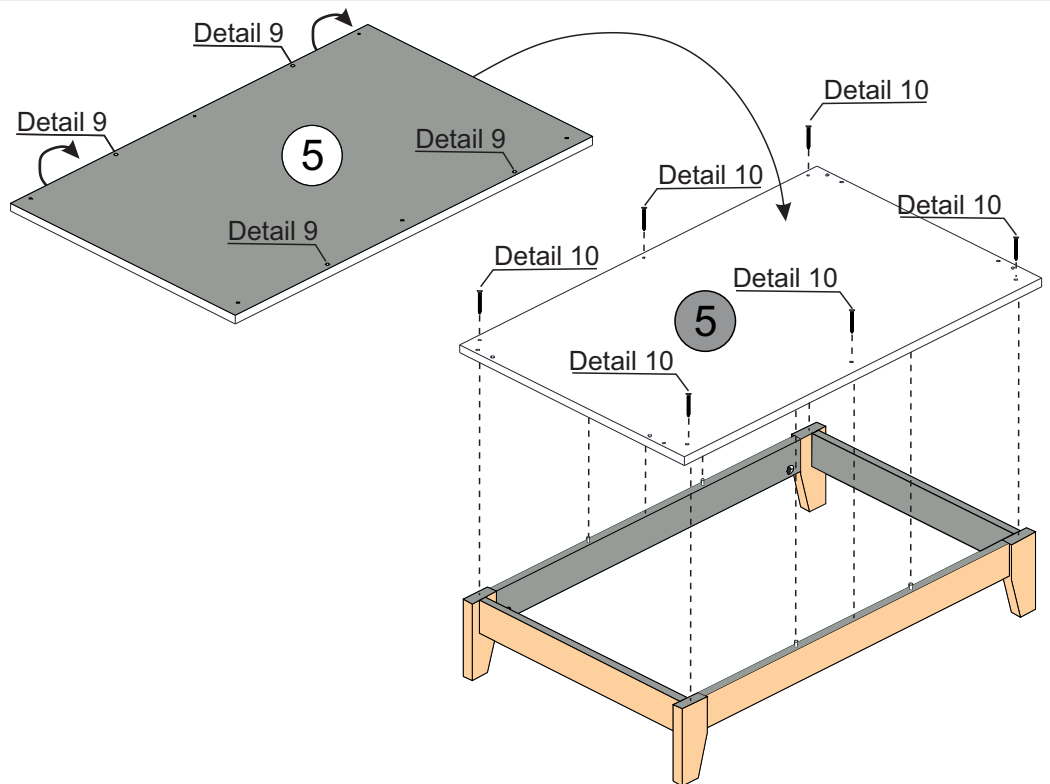
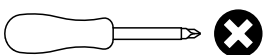

Detail 9

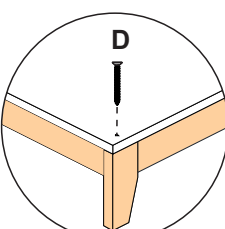

Detail 10

STEP 15

PARTS REQUIRED

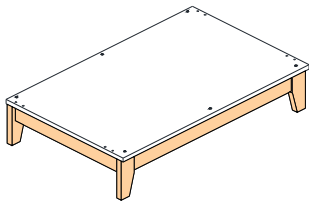

HARDWARE REQUIRED



TOOLS REQUIRED

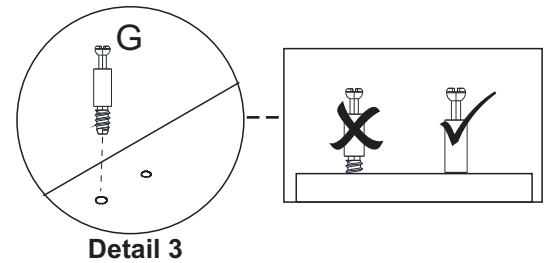
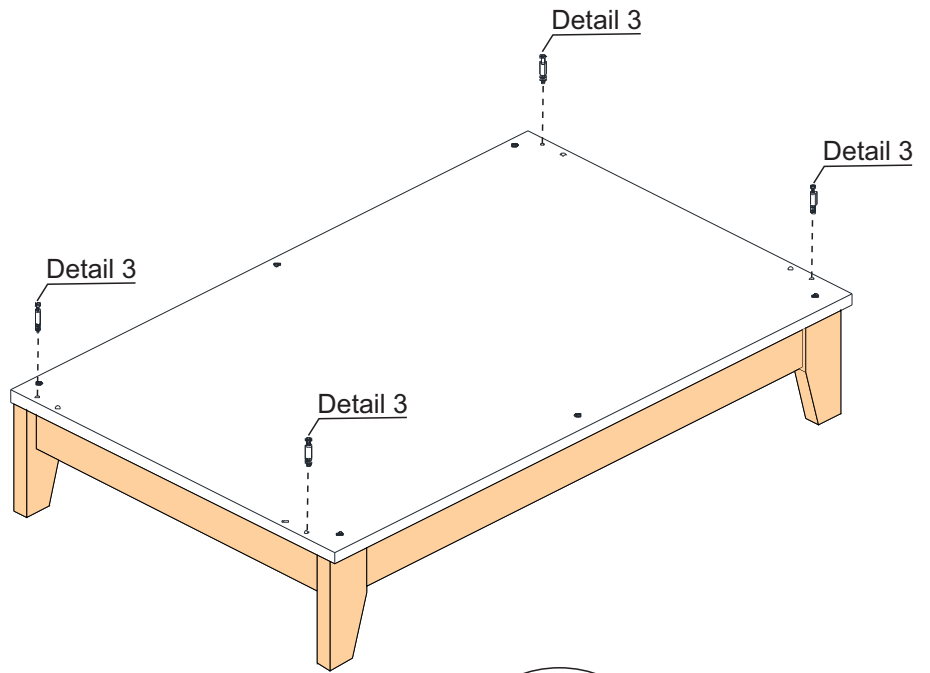
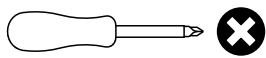

Detail 3

STEP 16

PARTS REQUIRED

6- LEFT SIDE PANEL	x1
--------------------	----

7- CENTRE SUPPORT	x1
-------------------	----

8- RIGHT SIDE PANEL	x1
---------------------	----

HARDWARE REQUIRED

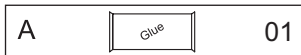

TOOLS REQUIRED

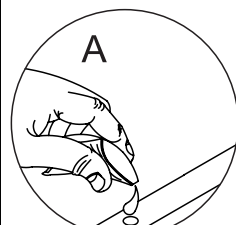
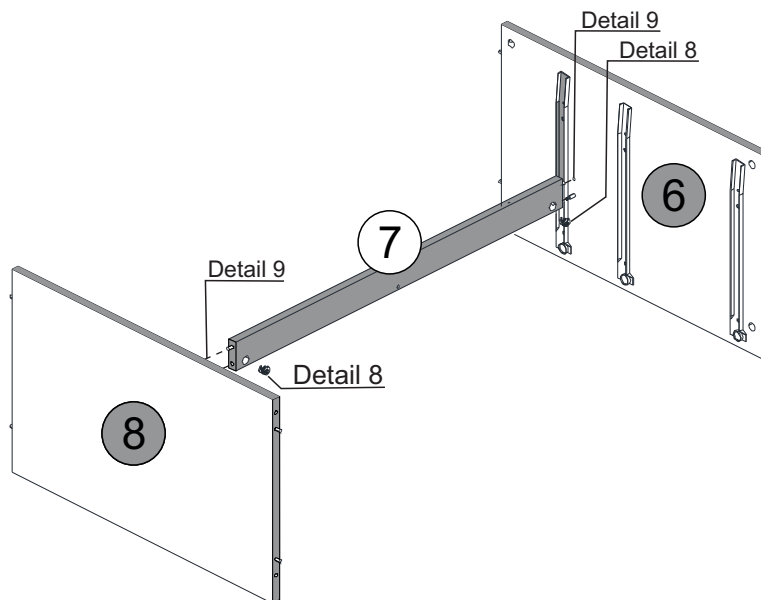
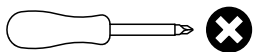

Detail 9

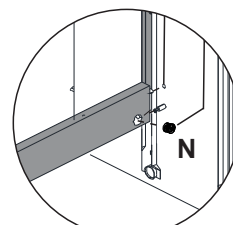

Detail 8

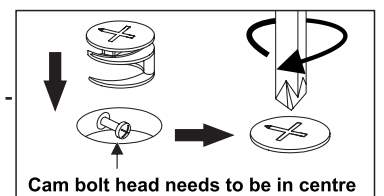



STEP 17

PARTS REQUIRED

9- DIVIDING PANEL	x1
10- TOP PANEL	x1

HARDWARE REQUIRED

A		01
N		02

TOOLS REQUIRED

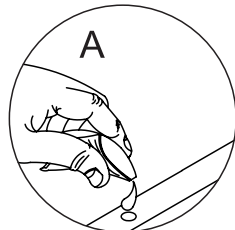
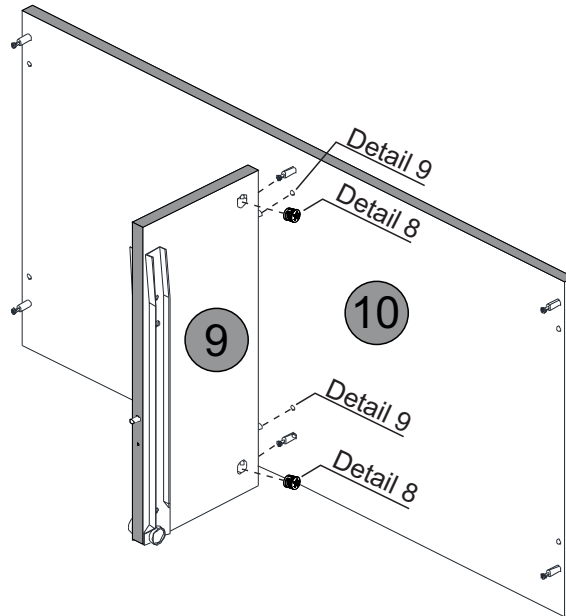
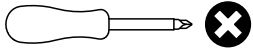

Detail 9

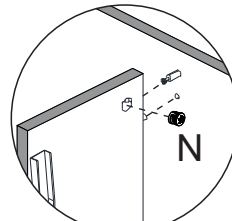

Detail 8

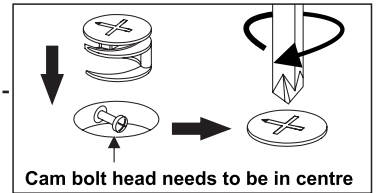

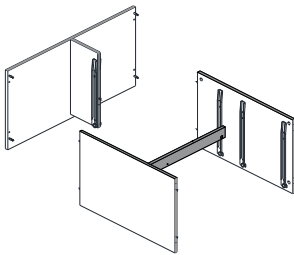

STEP 18

PARTS REQUIRED



HARDWARE REQUIRED

A		01
N		04
R	 Ø4,0 x 50mm	01

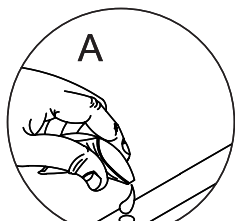
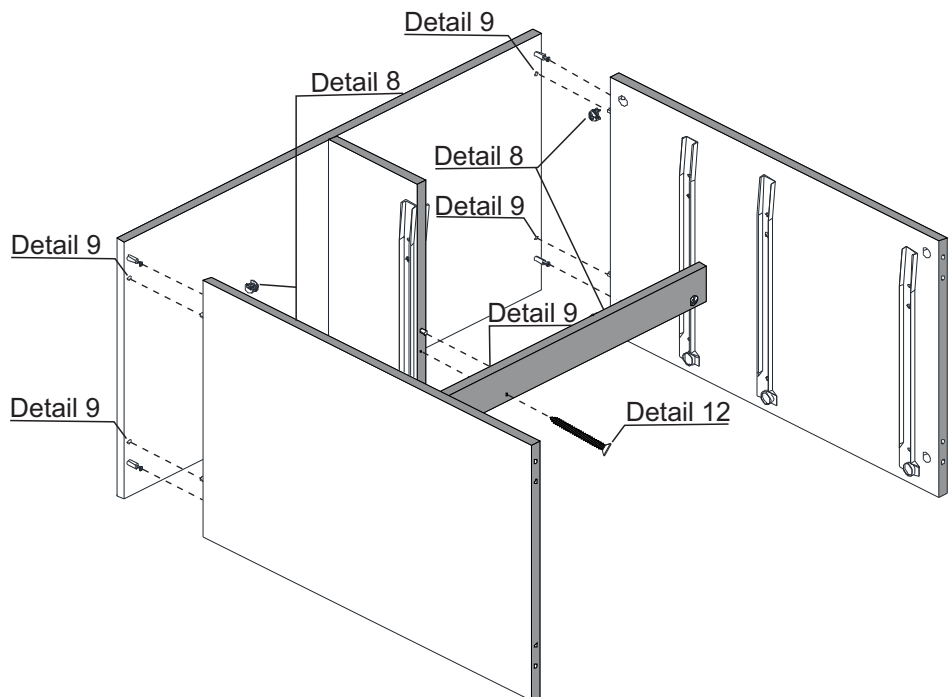

Detail 9

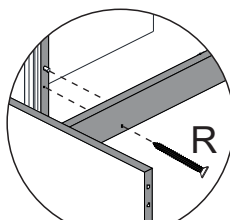

Detail 12

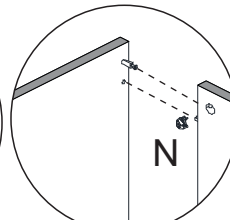

Detail 8

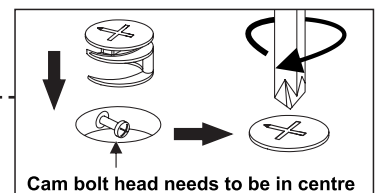

STEP 19

PARTS REQUIRED

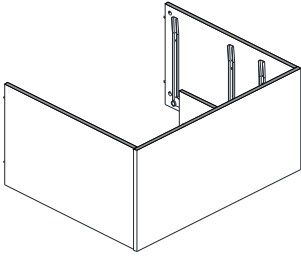

HARDWARE REQUIRED

A		01
N		04

TOOLS REQUIRED

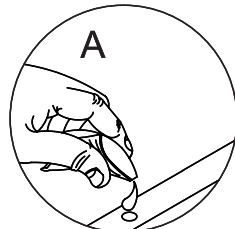
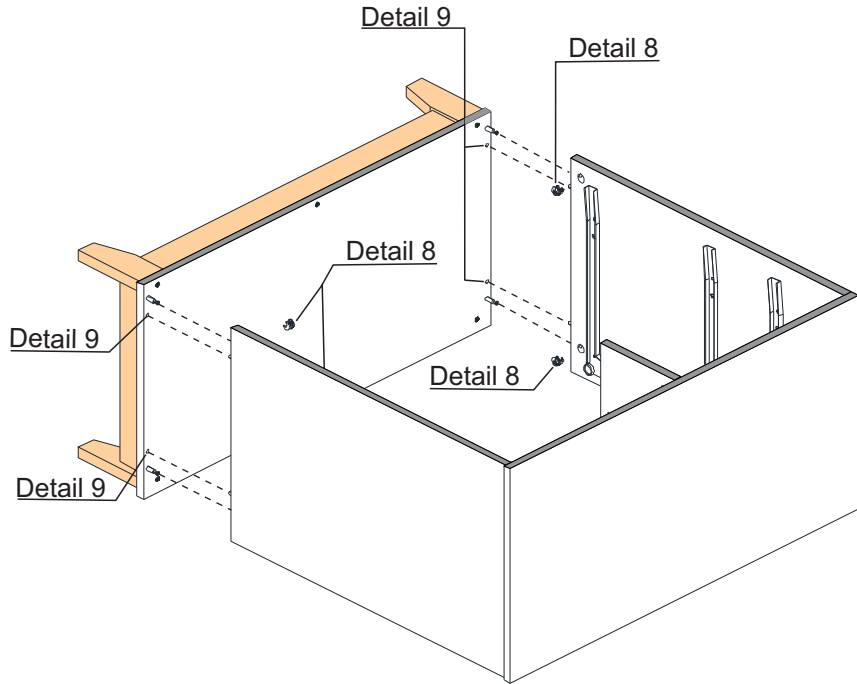
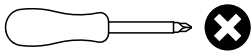

Detail 9

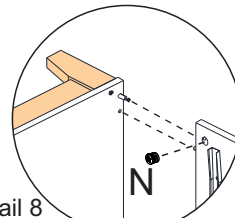

Detail 8

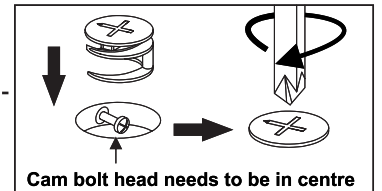

STEP 20

PARTS REQUIRED

11- BACK PANEL	x2
----------------	----

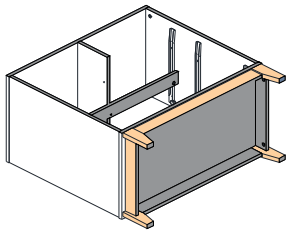

HARDWARE REQUIRED

E		24
Q		04
S		01

TOOLS REQUIRED

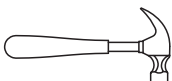

FOR YOUR REFERENCE
ORDER NUMBER
SHOULD BE HERE.

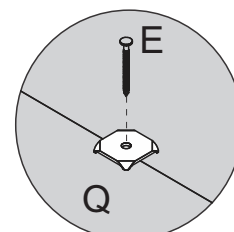
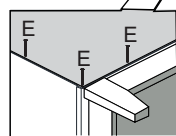
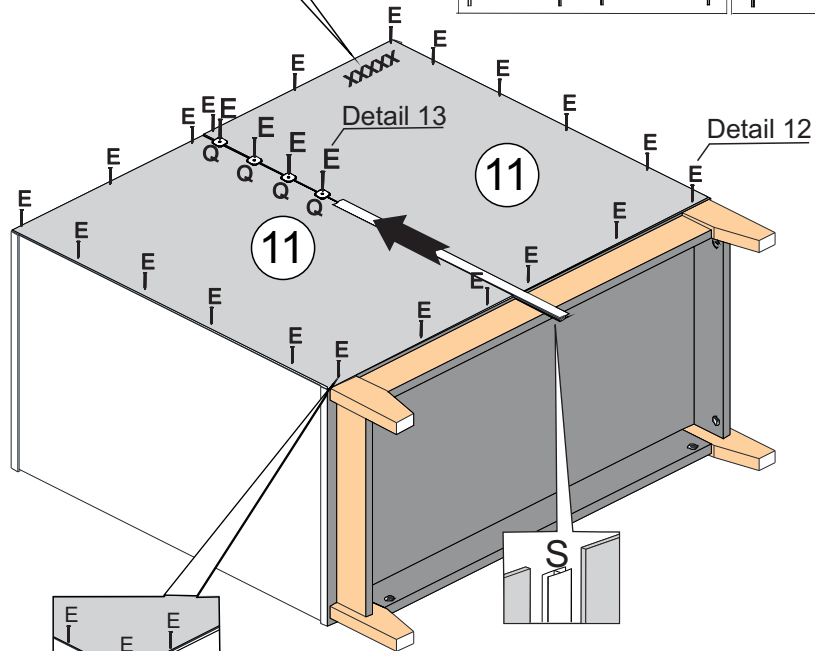
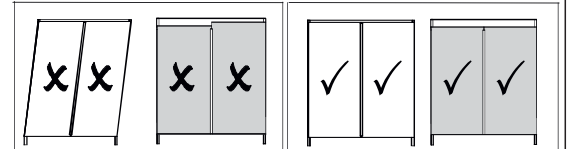

Detail 13

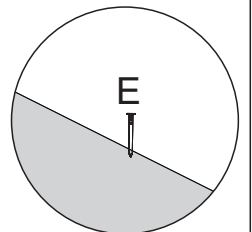

Detail 12

STEP 21

PARTS REQUIRED

- 12- DRAWER BACK(LARGE) x1
- 13- DRAWER SIDES x6
- 14- DRAWER BACK(SMALL) x2
- 19- DRAWER BACK(MEDIUM) x1
- 22- DRAWER SIDES(LARGE) x2
- 23- DRAWER BASE SUPPORT x2

HARDWARE REQUIRED

- A  01
- B  Ø6 x 30mm 36

TOOLS REQUIRED

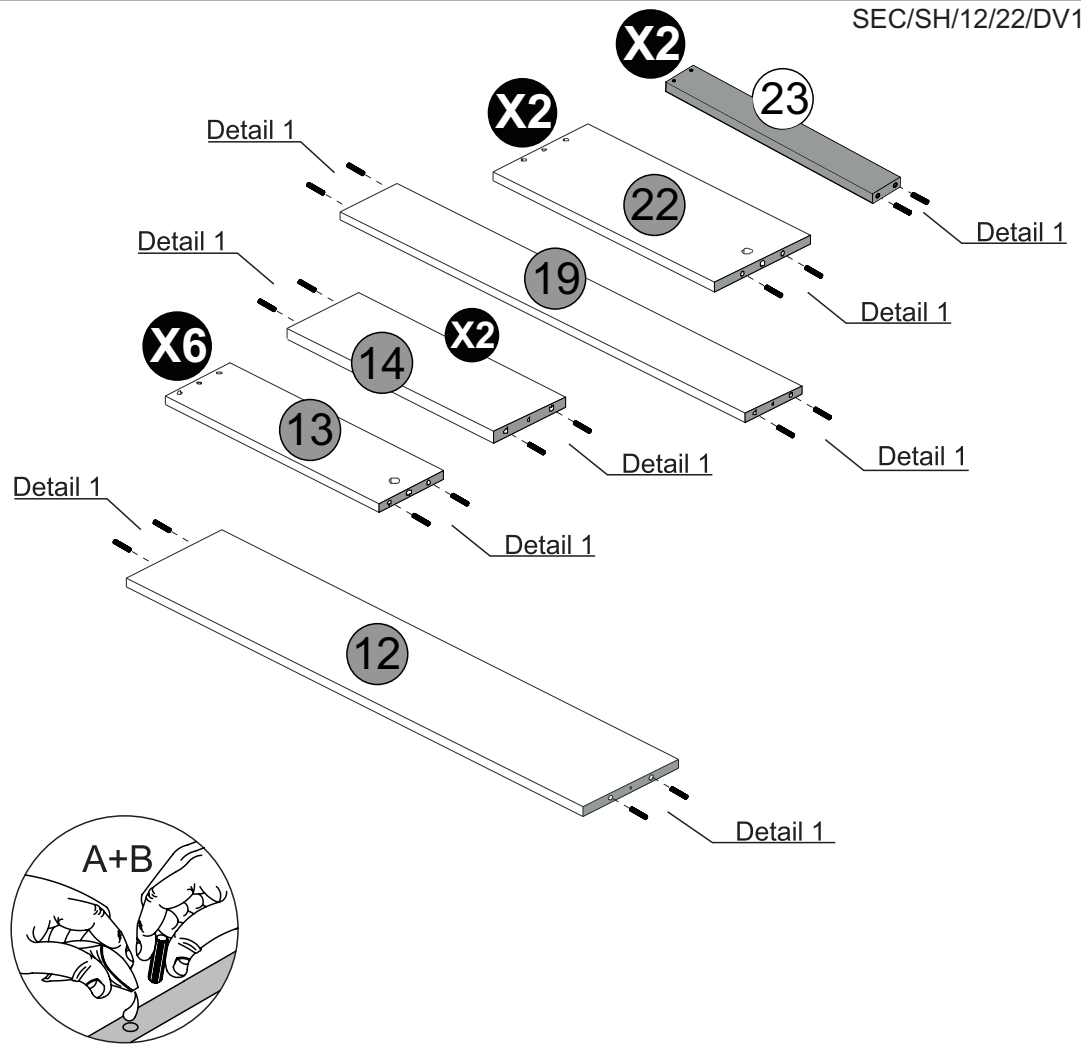
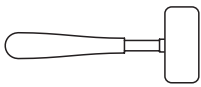

STEP 22

PARTS REQUIRED

- 15- DRAWER FRONT PINE LARGE x1
- 17- DRAWER FRONT(LEFT) x1
- 18- DRAWER FRONT(RIGHT) x1
- 21- CENTRE DRAWER FRONT x1

HARDWARE REQUIRED

- G  08

TOOLS REQUIRED

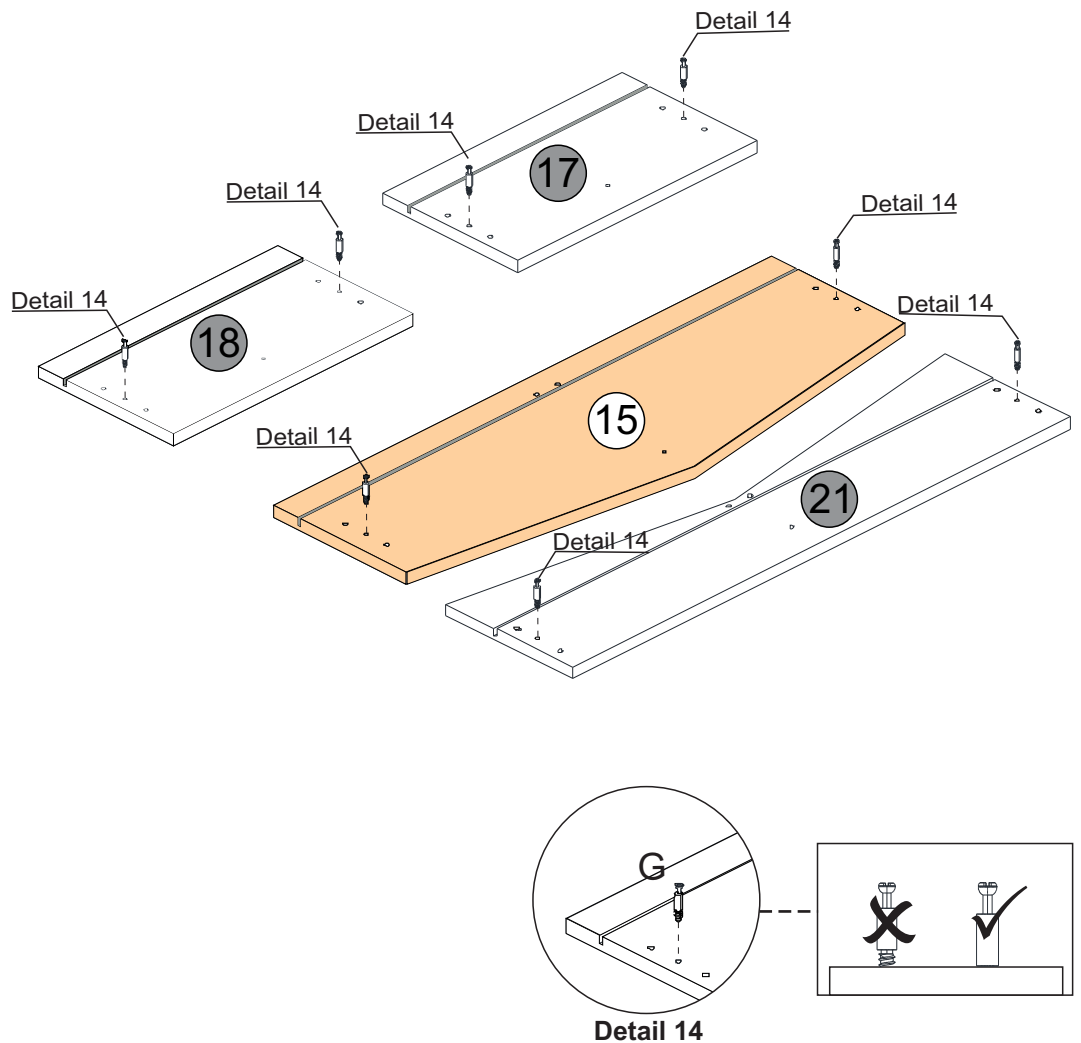

STEP 23

PARTS REQUIRED

13- DRAWER SIDES x4

14- DRAWER BACK(SMALL) x2

HARDWARE REQUIRED

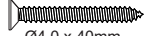
D  04
Ø4,0 x 40mm

TOOLS REQUIRED

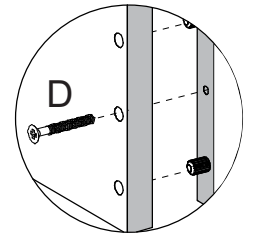
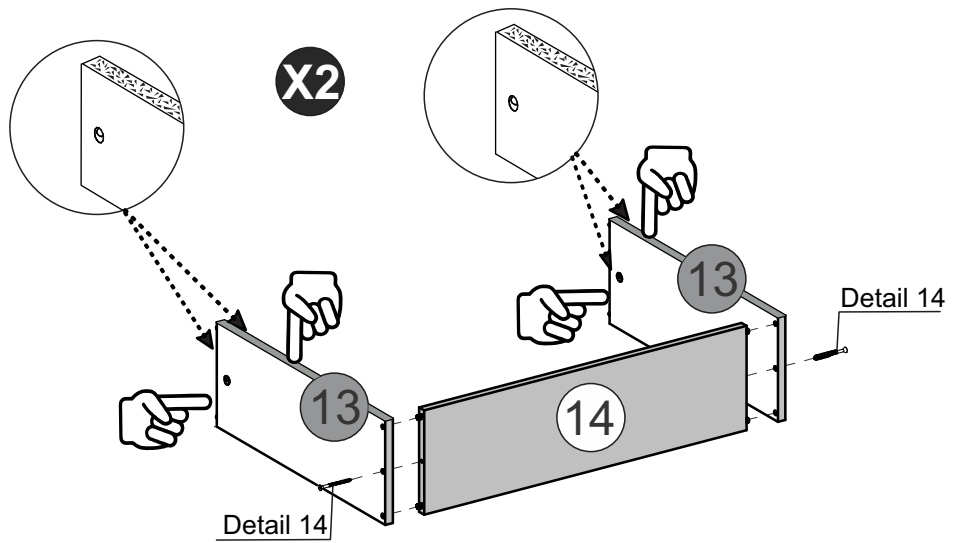
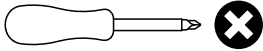

Detail 14

STEP 24

PARTS REQUIRED

17 - DRAWER FRONT(LEFT) x1

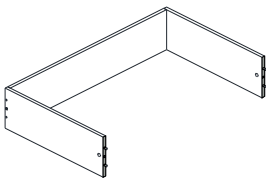

HARDWARE REQUIRED

A  01

F  Ø12mm 02

J  02

TOOLS REQUIRED

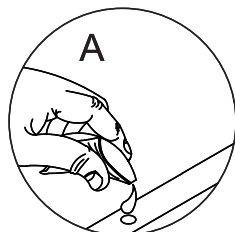
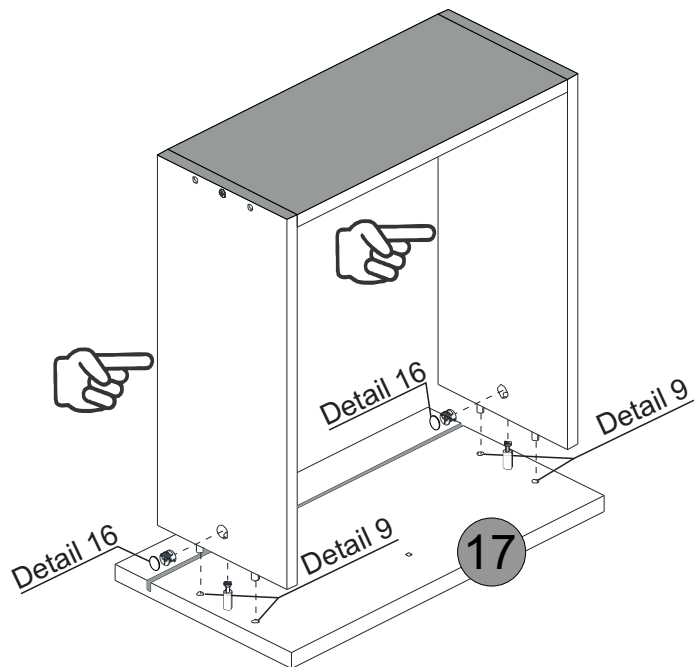
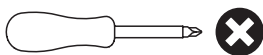

Detail 9

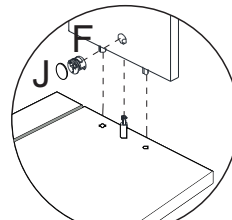

Detail 16

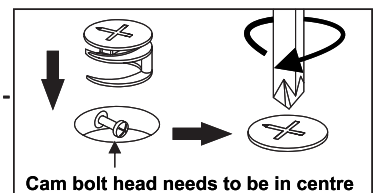

STEP 25

PARTS REQUIRED

18 - DRAWER FRONT(RIGHT) x1

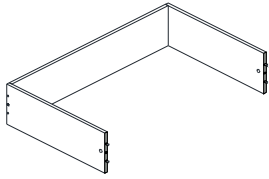

HARDWARE REQUIRED

A  01

F  Ø12mm 02

J  02

TOOLS REQUIRED

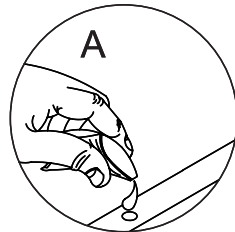
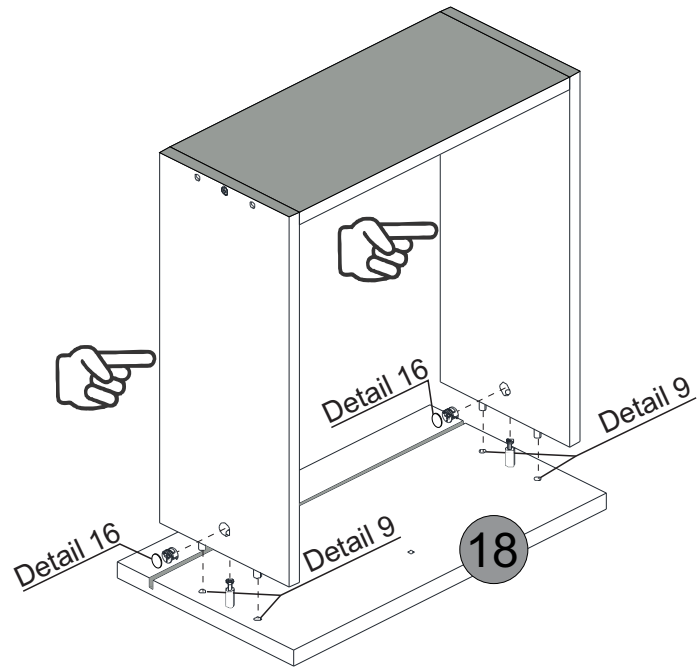
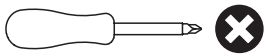

Detail 9

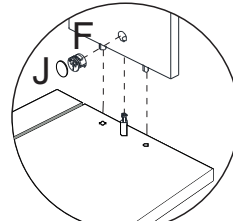

Detail 16

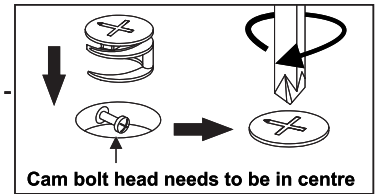

Cam bolt head needs to be in centre

STEP 26

PARTS REQUIRED

16 - DRAWER BASE x2

X2

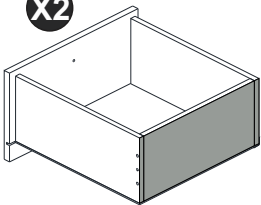

HARDWARE REQUIRED

E  10

TOOLS REQUIRED

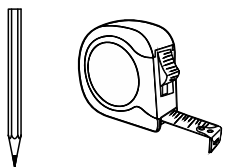
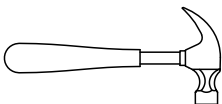

X2

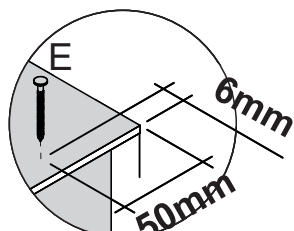
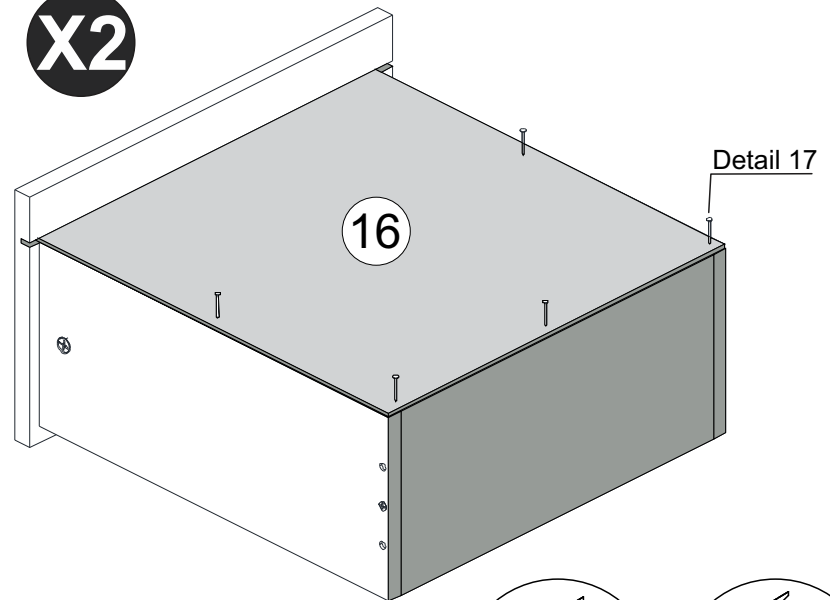

Detail 17

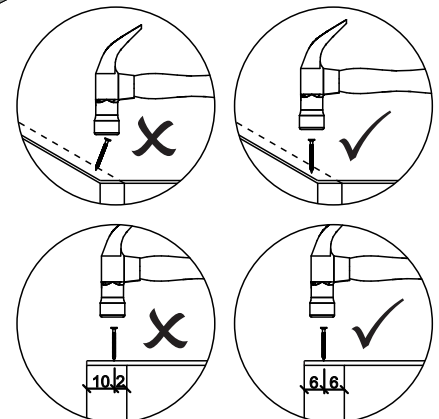

STEP 27

PARTS REQUIRED

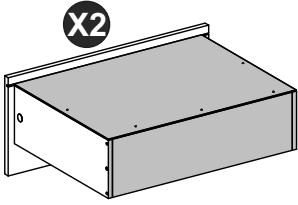

HARDWARE REQUIRED

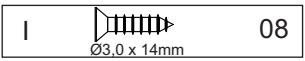

TOOLS REQUIRED

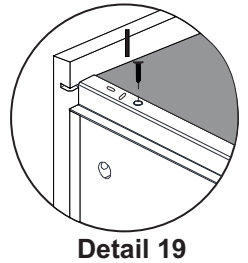
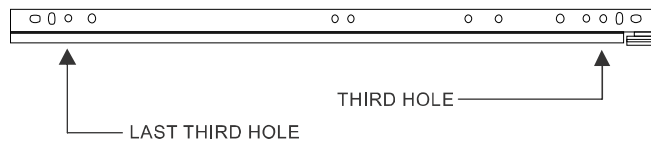
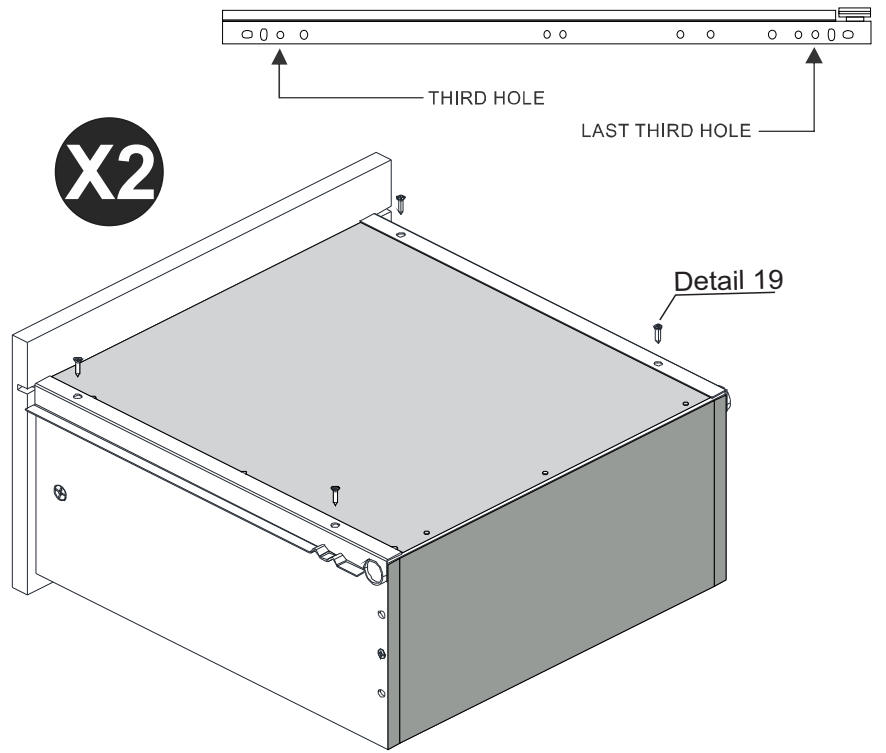
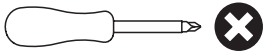

STEP 28

PARTS REQUIRED

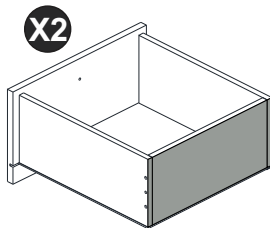

HARDWARE REQUIRED

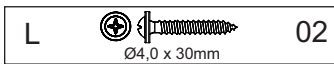

TOOLS REQUIRED

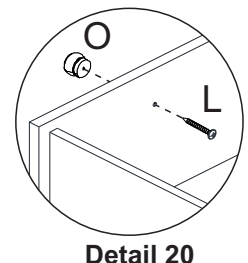
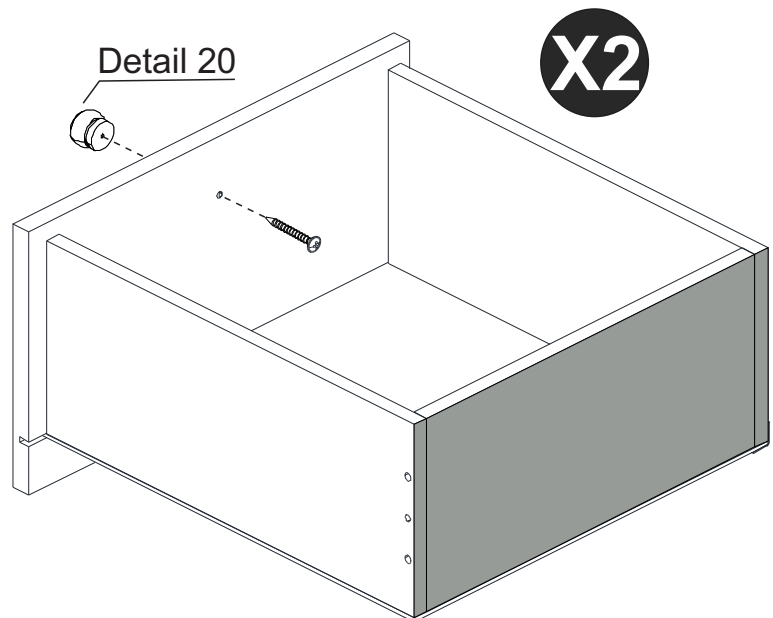
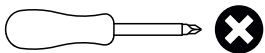

STEP 29

PARTS REQUIRED

13- DRAWER SIDES x2

19- DRAWER BACK(MEDIUM) x1

HARDWARE REQUIRED

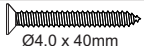
D  02
Ø4,0 x 40mm

TOOLS REQUIRED

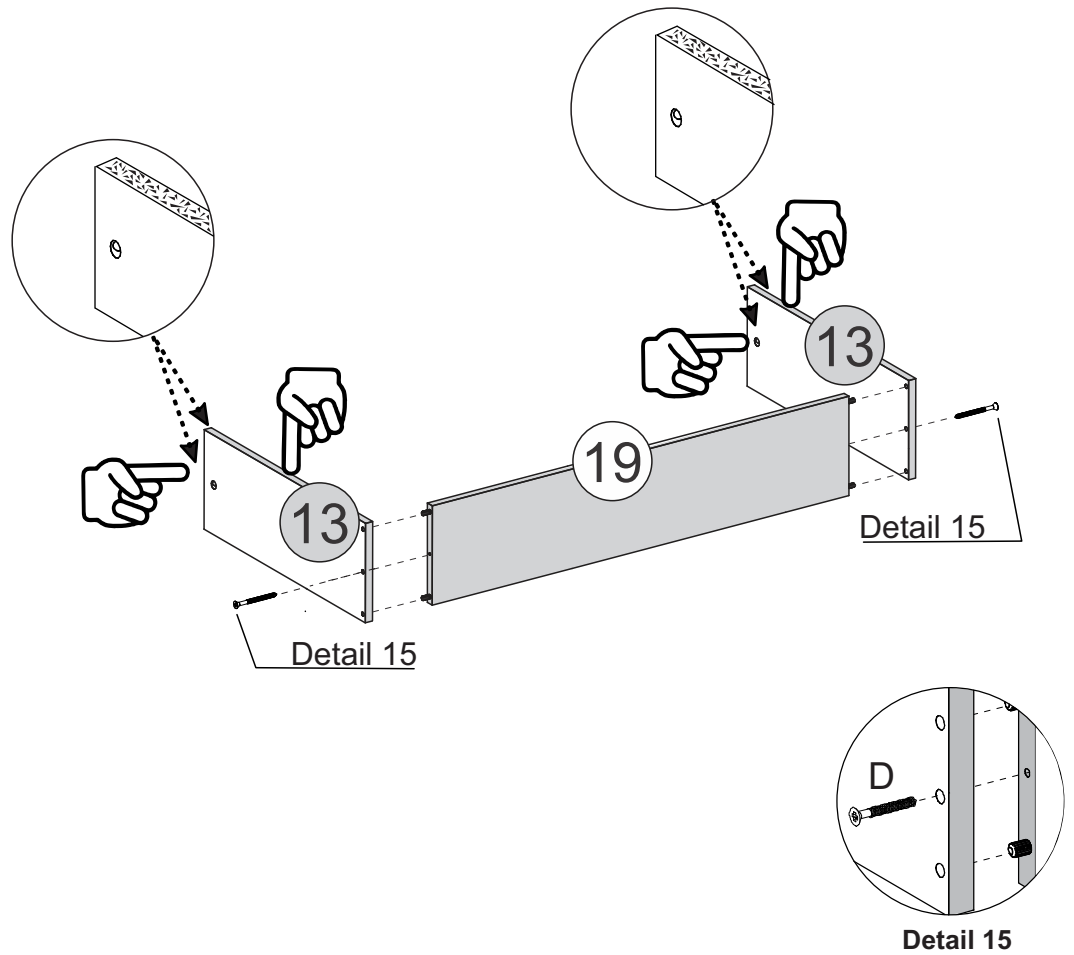
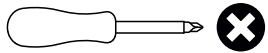

STEP 30

PARTS REQUIRED

21 - CENTRE DRAWER FRONT x1

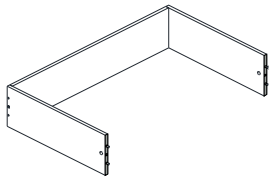

HARDWARE REQUIRED

A  01

F  Ø12mm 02

J  02

TOOLS REQUIRED

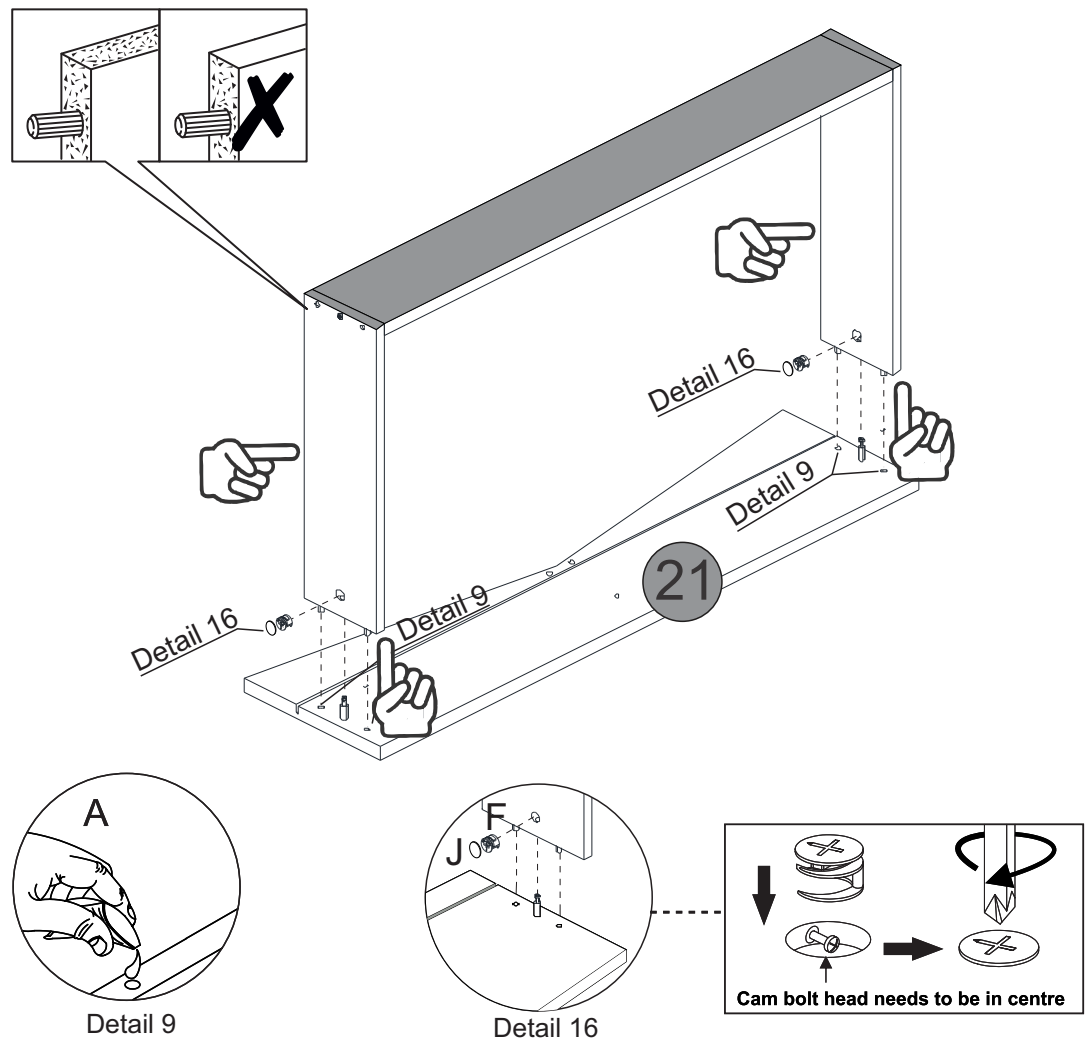
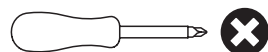

STEP 31

PARTS REQUIRED

20- DRAWER BASE(LARGE) x1

23- DRAWER BASE SUPPORT x1

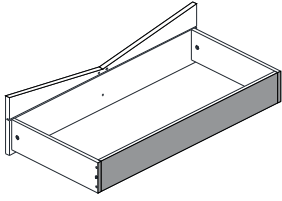

HARDWARE REQUIRED

A  01

E  08

TOOLS REQUIRED

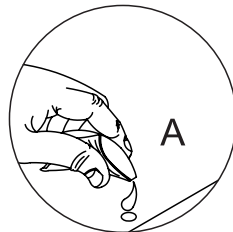
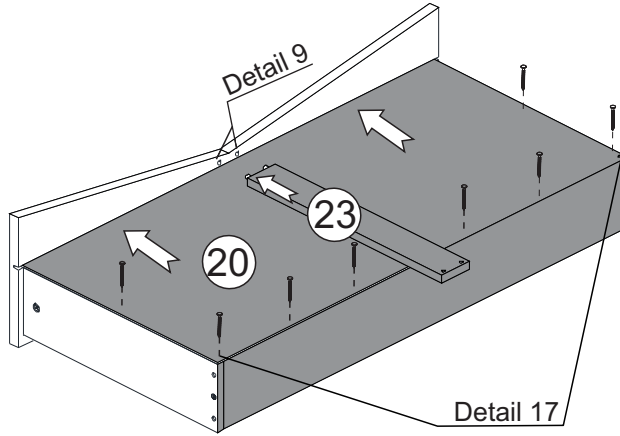
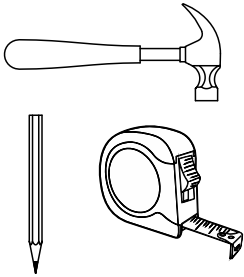

Detail 9

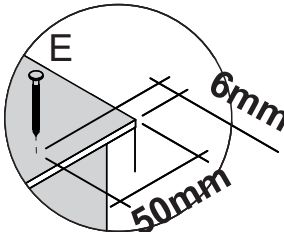

Detail 17

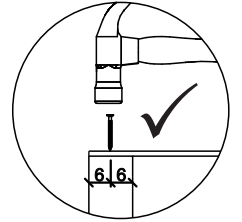
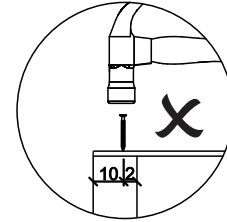
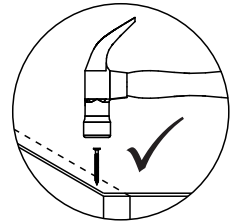
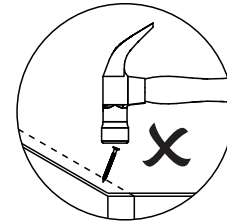

STEP 32

PARTS REQUIRED

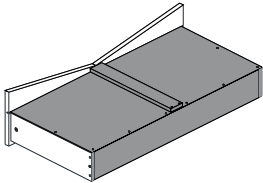

HARDWARE REQUIRED

C LEFT  01

C RIGHT  01

I  04
Ø3,0 x 14mm

P  02
Ø3,5 x 25mm

TOOLS REQUIRED

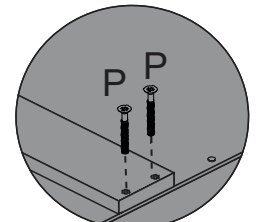
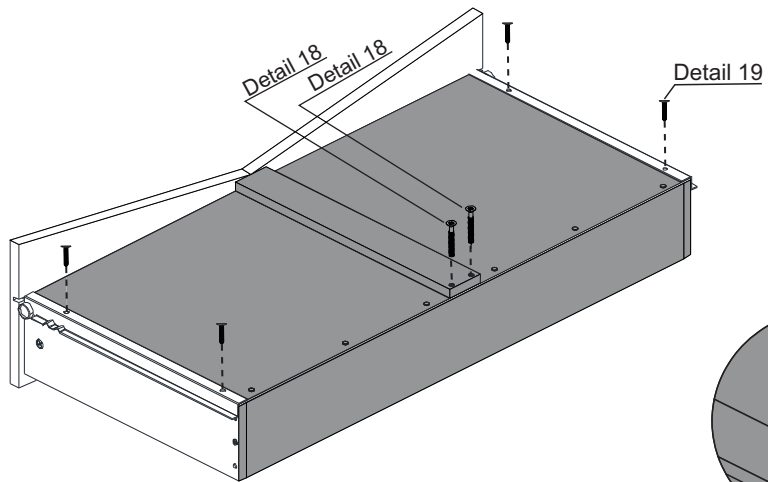
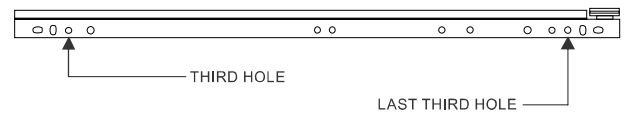
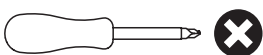

Detail 18

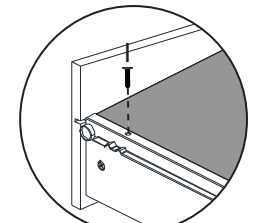

Detail 19

STEP 33

PARTS REQUIRED

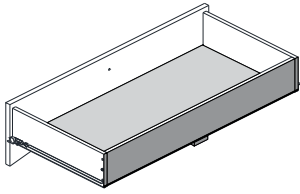

HARDWARE REQUIRED

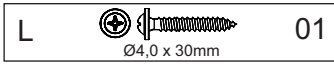
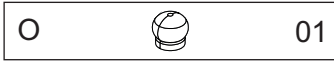

TOOLS REQUIRED

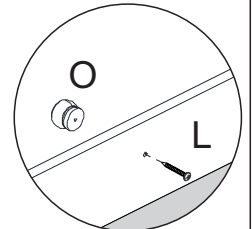
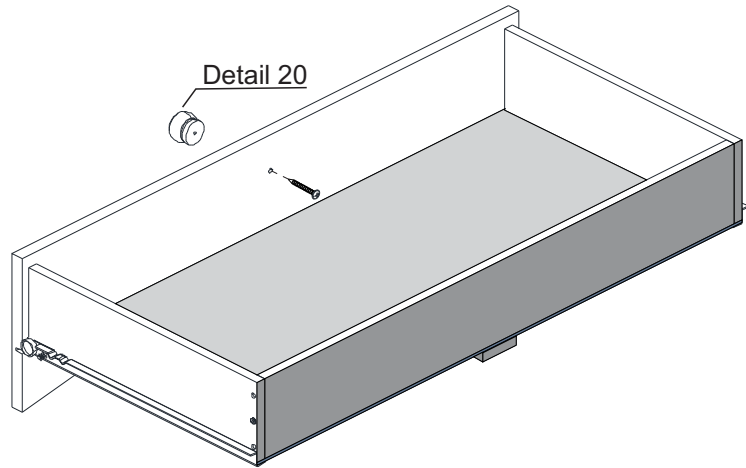
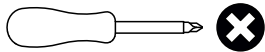

Detail 20

STEP 34

PARTS REQUIRED

22- DRAWER SIDES(LARGE) x2

12- DRAWER BACK(LARGE) x1

HARDWARE REQUIRED

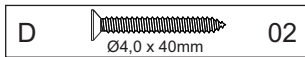

TOOLS REQUIRED

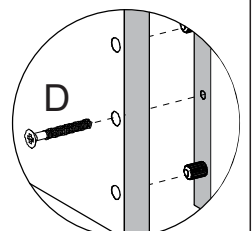
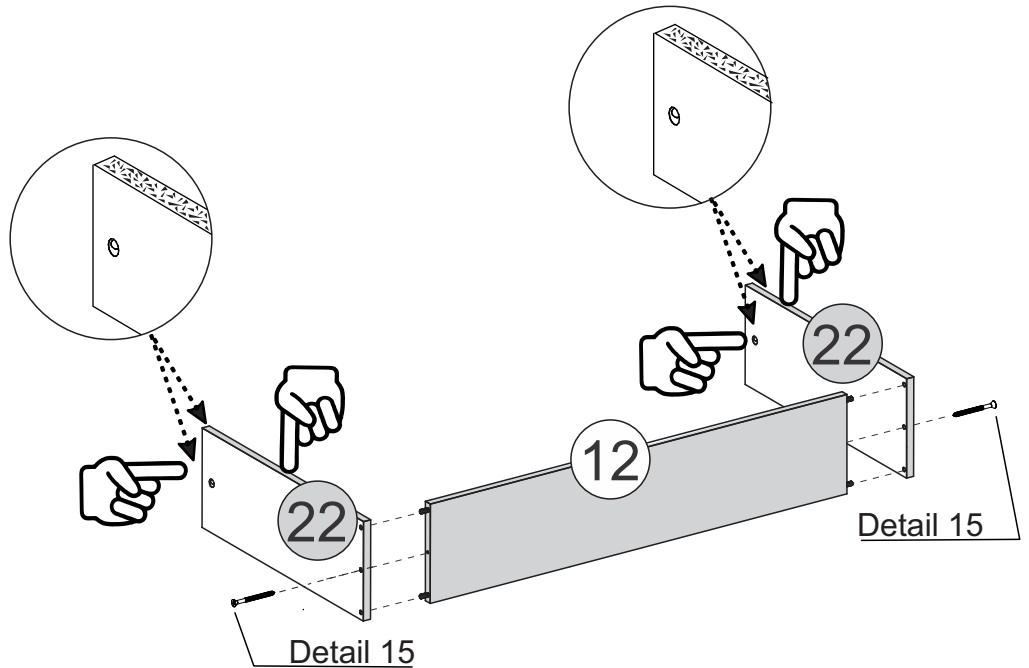
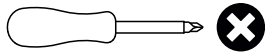

Detail 15

STEP 35

PARTS REQUIRED

15 - DRAWER FRONT PINE(LARGE) x1

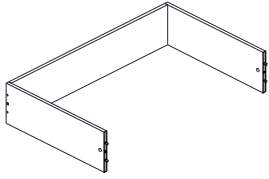

HARDWARE REQUIRED

A 01

F Ø12mm 02

J 02

TOOLS REQUIRED

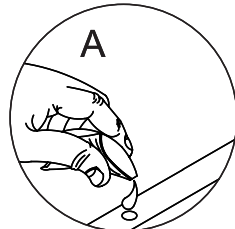
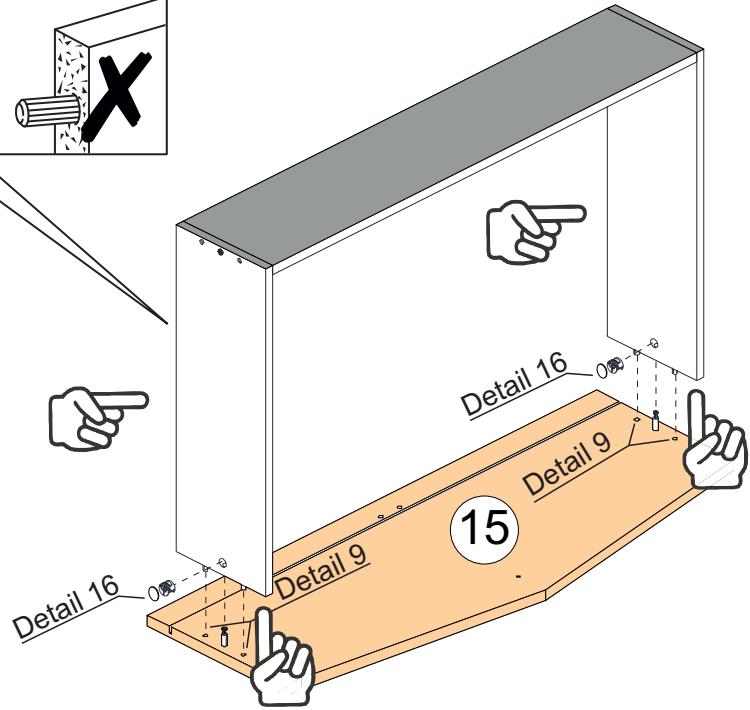
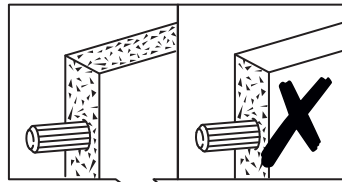
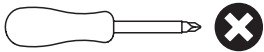

Detail 9

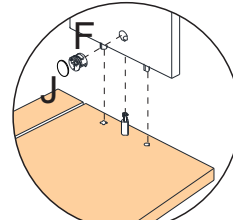

Detail 16

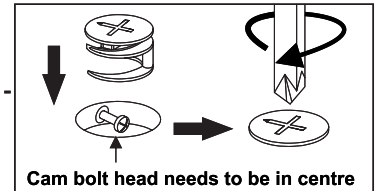

STEP 36

PARTS REQUIRED

20- DRAWER BASE(LARGE) x1

23- DRAWER BASE SUPPORT x1

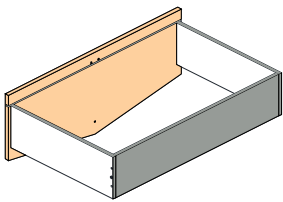

HARDWARE REQUIRED

A 01

E 08

TOOLS REQUIRED

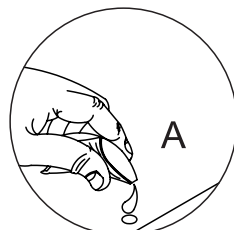
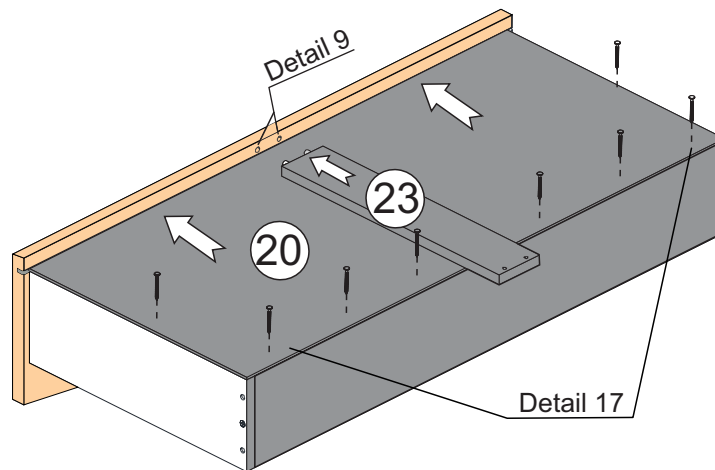
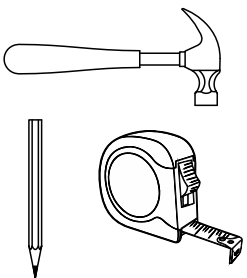

Detail 9

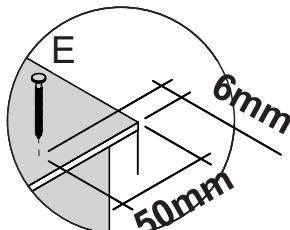

Detail 17

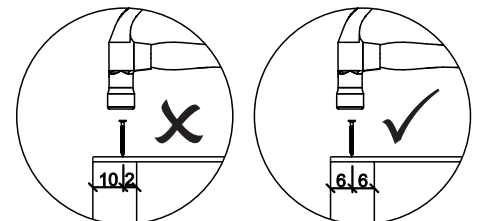
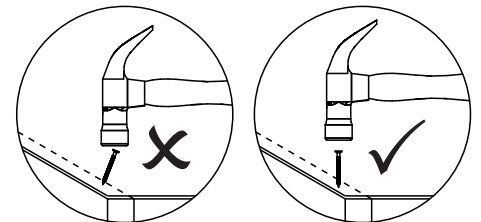

STEP 37

PARTS REQUIRED

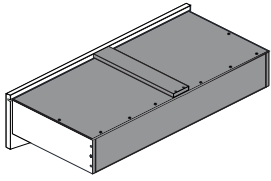

HARDWARE REQUIRED

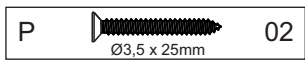
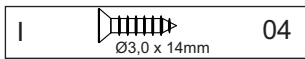

TOOLS REQUIRED

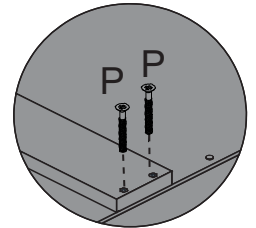
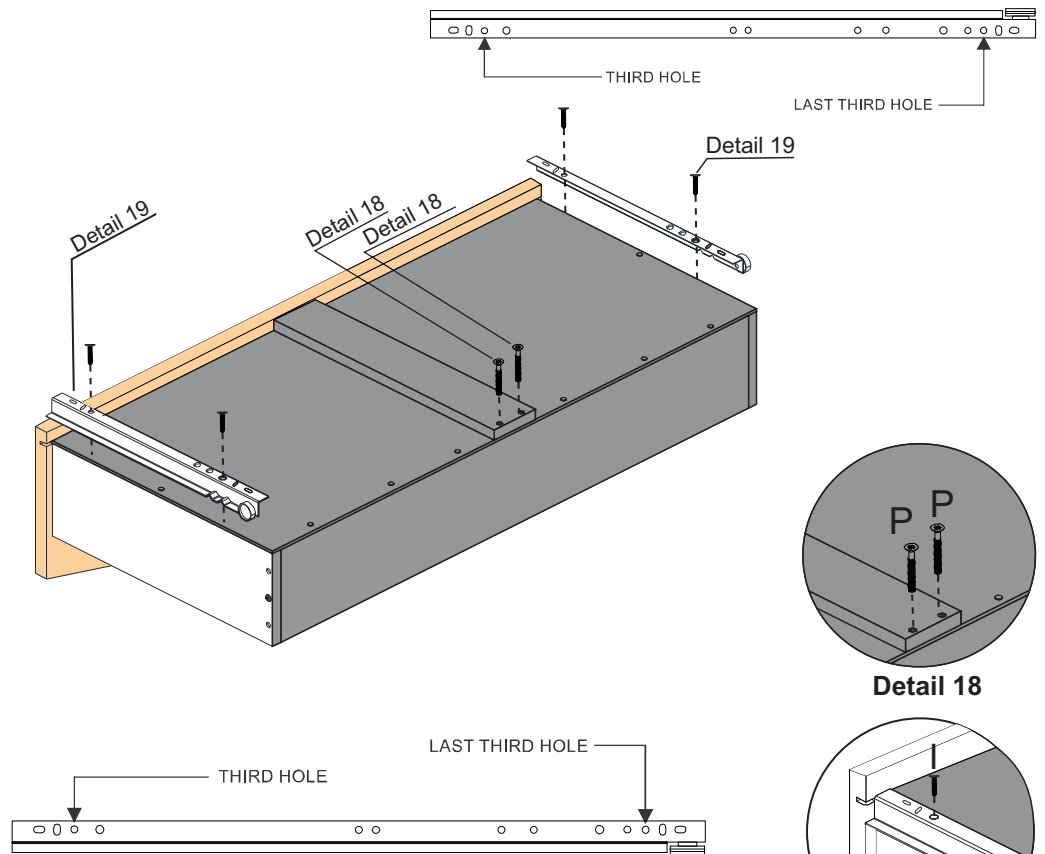
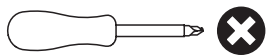

Detail 18

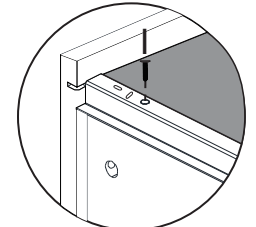

Detail 19

STEP 38

PARTS REQUIRED

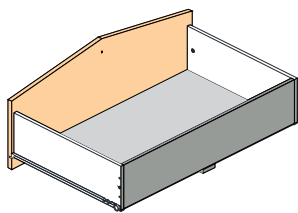

HARDWARE REQUIRED

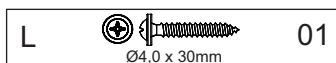
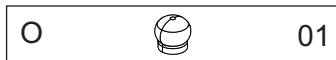

TOOLS REQUIRED

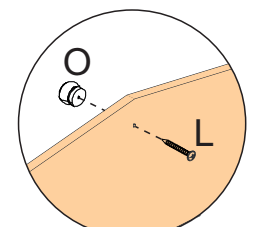
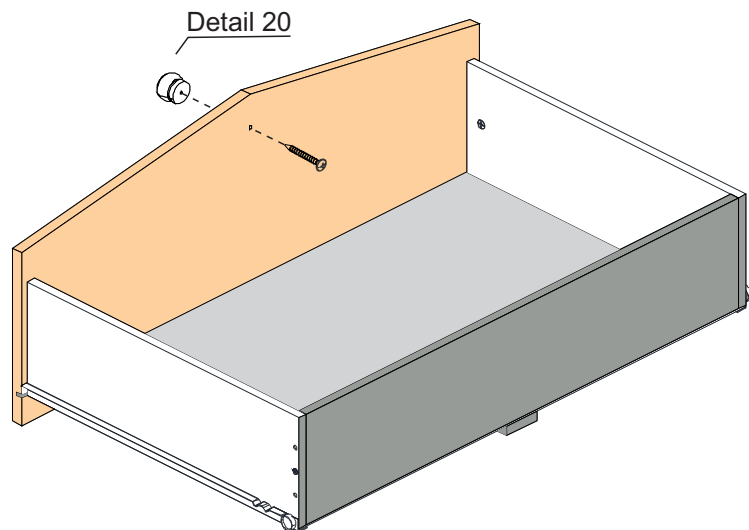
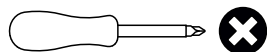

Detail 20

STEP 39

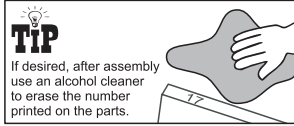

PARTS REQUIRED

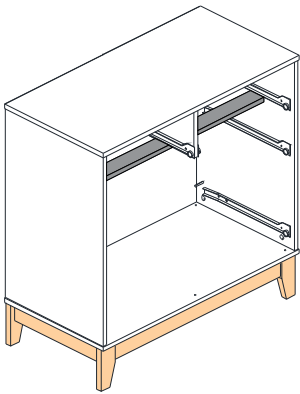

HARDWARE REQUIRED

TOOLS REQUIRED

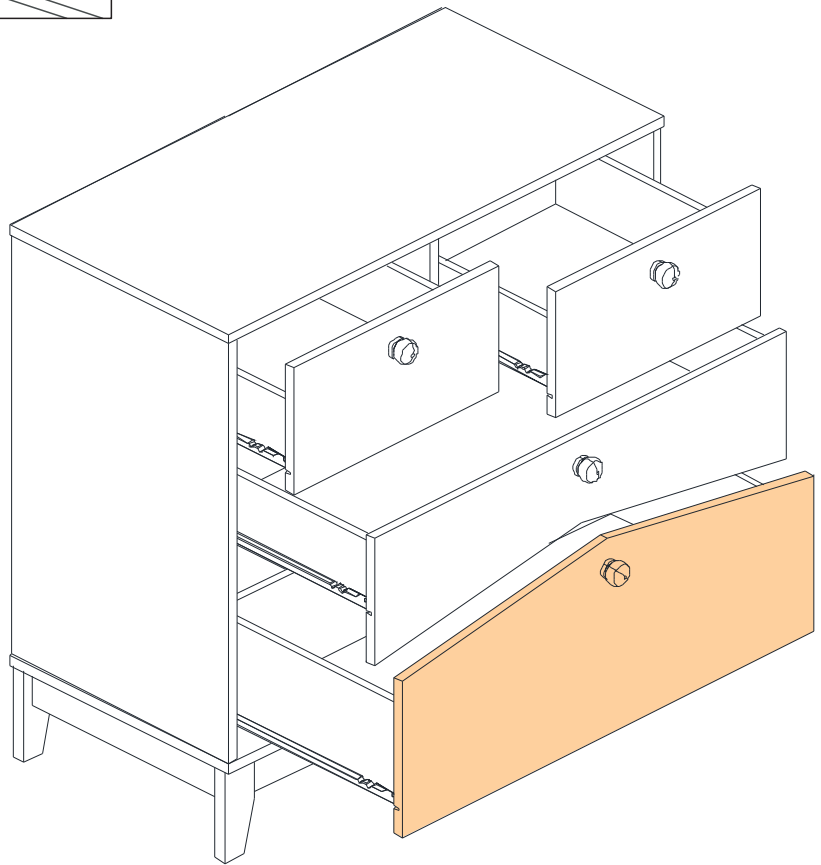

STEP 40

PARTS REQUIRED

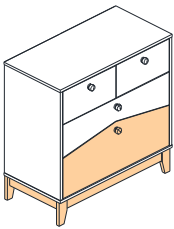

HARDWARE REQUIRED

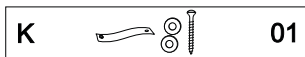

TOOLS REQUIRED

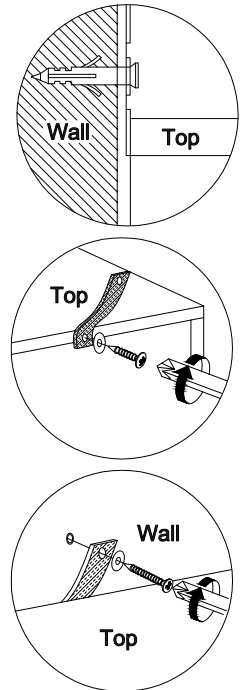
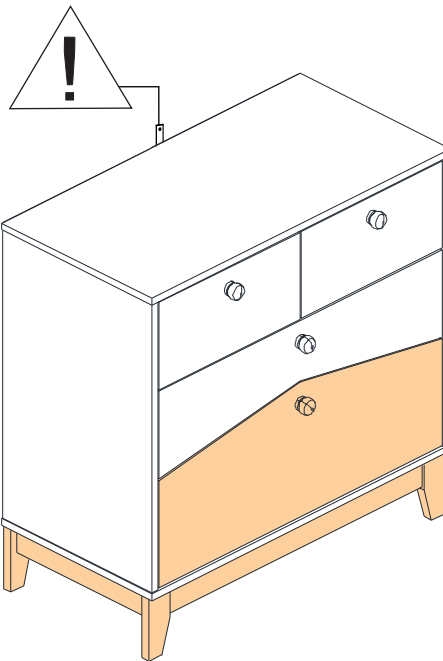
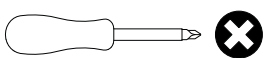

WARNING

Serious or fatal injuries can occur from furniture tipping over. To prevent the furniture from tipping over we recommend that it is permanently fixed to the wall.

Wall fixings are not supplied with this product as different wall materials require different types of fixing devices. Please make sure you use fixings suitable for the walls in your home.

CODY 2 DRAWER BEDSIDE ASSEMBLY INSTRUCTIONS WHITE/PINE EFFECT

XXXXXX

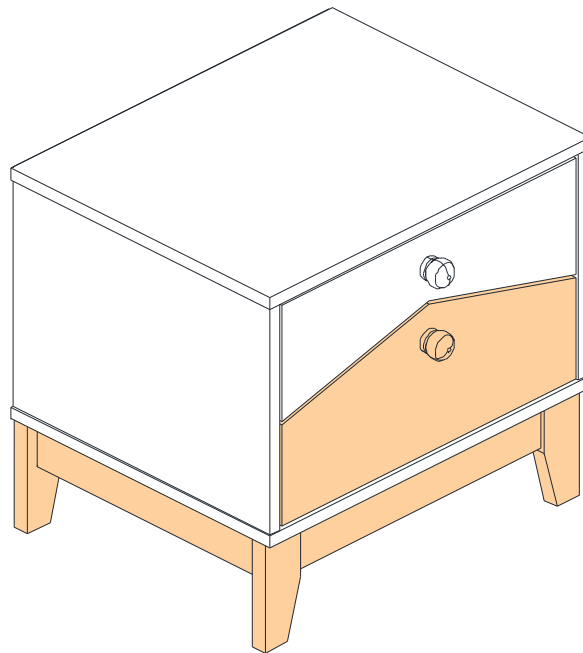

IMPORTANT FOR DOMESTIC USE ONLY PLEASE READ BEFORE YOU CONTINUE FURTHER CARE AND MAINTENANCE

After unpacking this product please keep the original packaging in case it needs to be returned for any reason.

- Please ensure all fittings and parts are present before commencing with assembly.
- Never drag or push products as this could cause damage to the joints making it inferior.
- We strongly recommend that you keep children away from your work area.
- We recommend that you lay a blanket or sheet on the floor to avoid damage to both your floor and the product.
- Assemble this product as close to its final position as possible.
- Do not place this product next to a radiator or in direct sunlight.
- Do not drag or push items across your high gloss furniture as this may cause the surface to scratch
- Wood is a natural product and may expand if subjected to damp and may shrink or crack if subjected to heat. Therefore it is recommended that room temperature is maintained, with no sudden temperature fluctuations.
- Make sure any spillage is wiped off immediately.
- Do not place hot or chilled items directly on to the surface, use a place mat or marking will occur.
- For general cleaning use a soft cotton or micro fibre cloth, and do not use detergents of any kind.
- From time to time it may be necessary to tighten fittings, regular inspections should be carried out.
- Do not place on a wet or damp floor as staining may occur to your floor.



* Use of power tools to assemble this product will invalidate any claim and could damage this product making it unsafe!!!
* Please assemble on a clean soft surface to avoid damage.



* Please check contents and read the instructions before commencing assembly.
* Assemble this product following the enclosed instructions carefully.
* Please take care to avoid damaging parts during assembly.

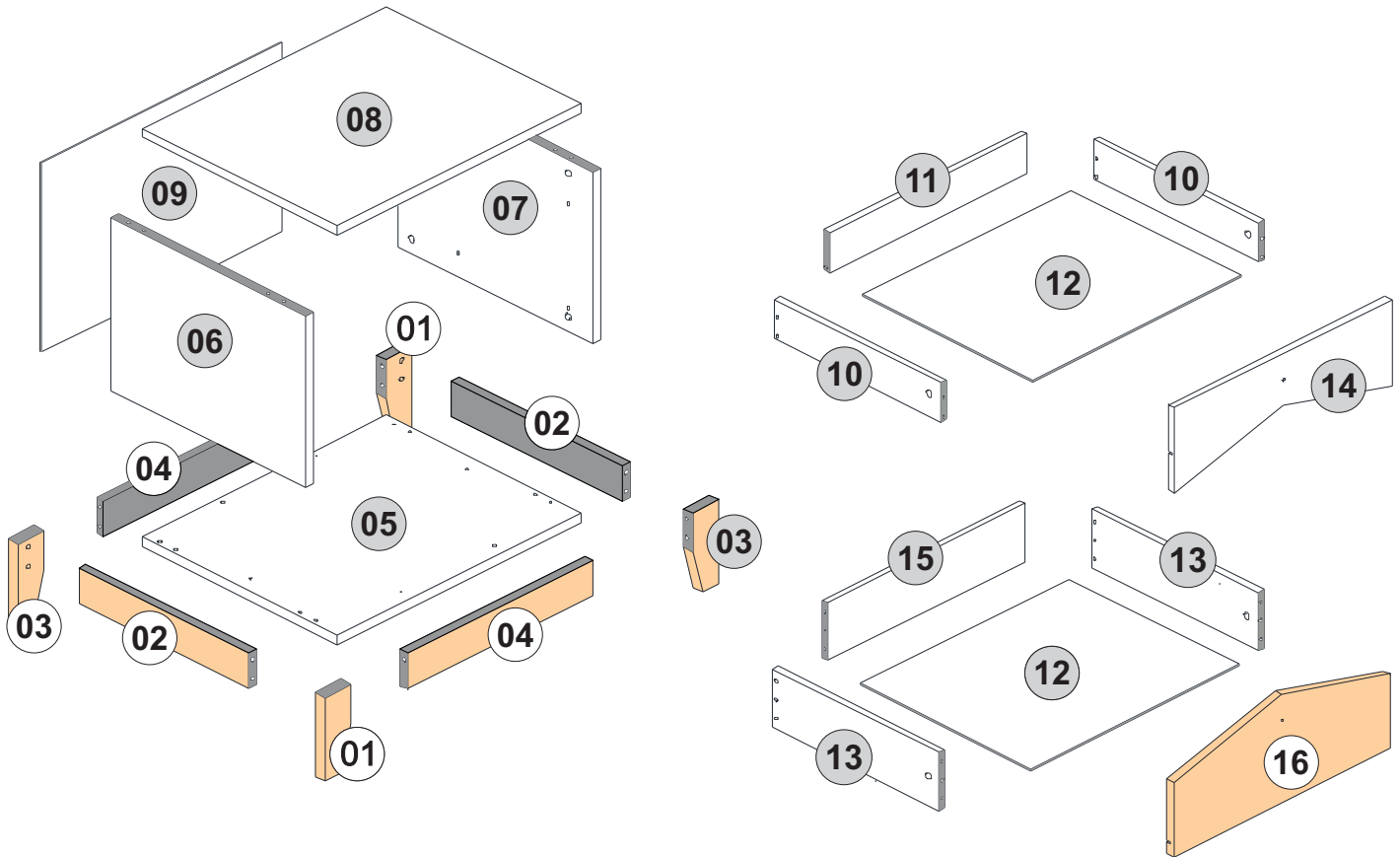











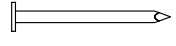

PART LIST

Please Note:

The below parts have all been stamped with the part number/color to help identify them during assembly.

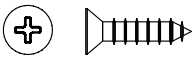
Part Number	Part Code	Part Description	Quantity	Carton
1	S100-103-090-DV1-01	Left Leg	2	1/1
2	S100-103-090-DV1-02	Leg Support Left & Right	2	1/1
3	S100-103-090-DV1-03	Right Leg	2	1/1
4	S100-103-090-DV1-04	Leg Support Front & Back	2	1/1
5	S100-103-090-DV1-05	Base Panel	1	1/1
6	S100-103-090-DV1-06	Left Side Panel	1	1/1
7	S100-103-090-DV1-07	Right Side panel	1	1/1
8	S100-103-090-DV1-08	Top Panel	1	1/1
9	S100-103-090-DV1-09	Back Panel	1	1/1
10	S100-103-090-DV1-10	Drawer Side (Small)	2	1/1
11	S100-103-090-DV1-11	Drawer Back (Small)	1	1/1
12	S100-103-090-DV1-12	Drawer Base	2	1/1
13	S100-103-090-DV1-13	Drawer Side (Large)	2	1/1
14	S100-103-090-DV1-14	Drawer Front White (Small)	1	1/1
15	S100-103-090-DV1-15	Drawer Back (Large)	1	1/1
16	S100-103-090-DV1-16	Drawer Front Pine (Large)	1	1/1

FITTINGS LIST

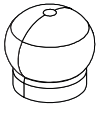
<p>A</p>  <p style="text-align: center;">Glue (2x)</p>	<p>B</p>  <p style="text-align: center;">2/+ Dowel Ø6,0 x 30mm (28x)</p>	<p>C</p>  <p style="text-align: center;">Slide 350mm (2x)</p>	<p>D</p>  <p style="text-align: center;">1/+ Flat Head Screw Ø4,0 x 40mm (8x)</p>
<p>E</p>  <p style="text-align: center;">2/+ Nail 10 x 10 (22x)</p>	<p>F</p>  <p style="text-align: center;">1/+ Cam Nut 12mm (4x)</p>	<p>G</p>  <p style="text-align: center;">1/+ Cam Bolt (20x)</p>	<p>H</p>  <p style="text-align: center;">1/+ Screw Ø 6x8 (8x)</p>
<p>I</p>  <p style="text-align: center;">1/+ Flat Head Screw Ø3,0 x 14mm (8x)</p>	<p>J</p>  <p style="text-align: center;">2/+ Hole Plugs (4x)</p>	<p>K</p>  <p style="text-align: center;">1/+ Flan Head Screw Ø4,0 x 30mm (2x)</p>	<p>L</p>  <p style="text-align: center;">1/+ Cam Nut 15mm (16x)</p>
<p>M</p>  <p style="text-align: center;">2/+ Dowel Ø8,0 x 30mm (8x)</p>	<p>N</p>  <p style="text-align: center;">Handle(2x)</p>		

TOOLS REQUIRED

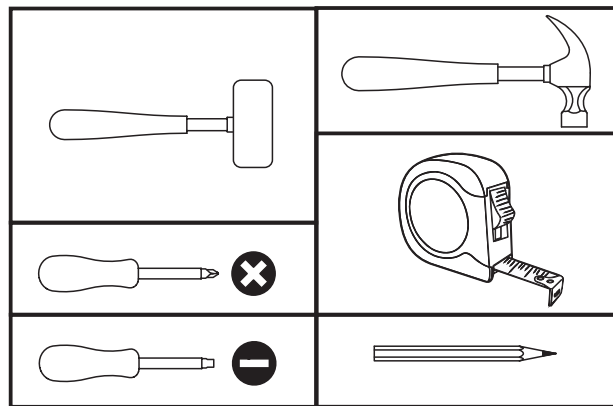

TIPS FOR FITTINGS CAM-LOCKS

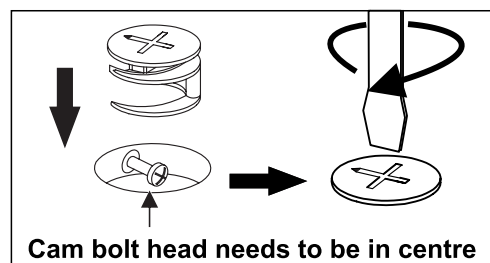
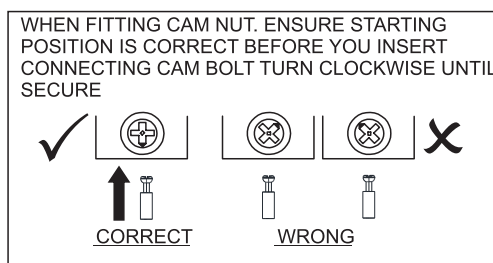

CAMBOLT

Tighten until shoulder in flush with panel. Do not overtighten or undertighten (see example beside)

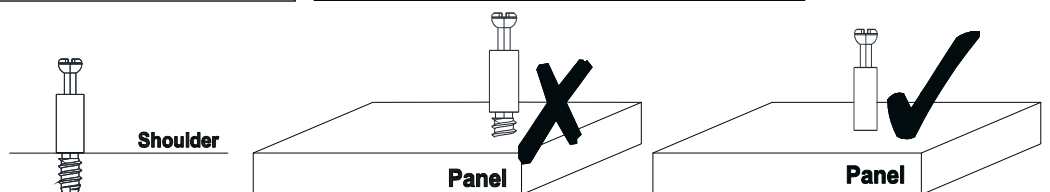

STEP 1

PARTS REQUIRED

1 - LEFT LEG x2

3 - RIGHT LEG x2

HARDWARE REQUIRED

G  08

TOOLS REQUIRED

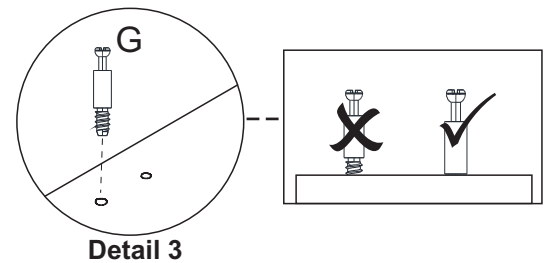
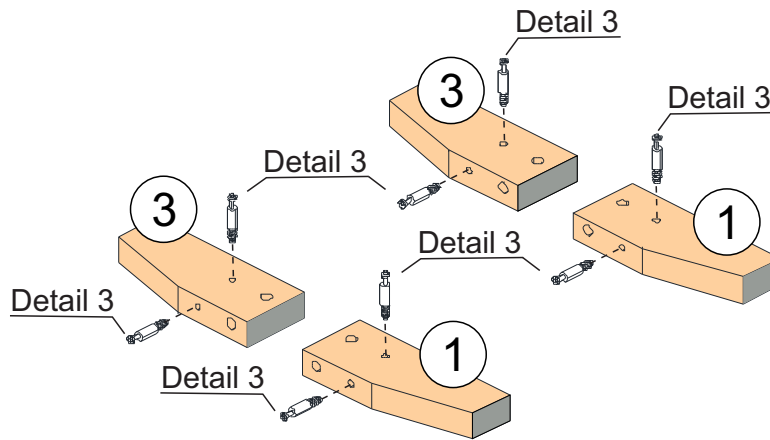
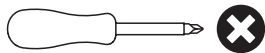

STEP 2

PARTS REQUIRED

2- LEG SUPPORT LEFT&RIGHT x2

4- LEG SUPPORT FRONT&BACK x2

HARDWARE REQUIRED

A  01

B  Ø6 x 30mm 04

M  Ø8 x 30mm 08

TOOLS REQUIRED

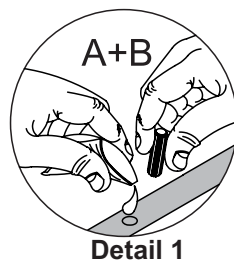
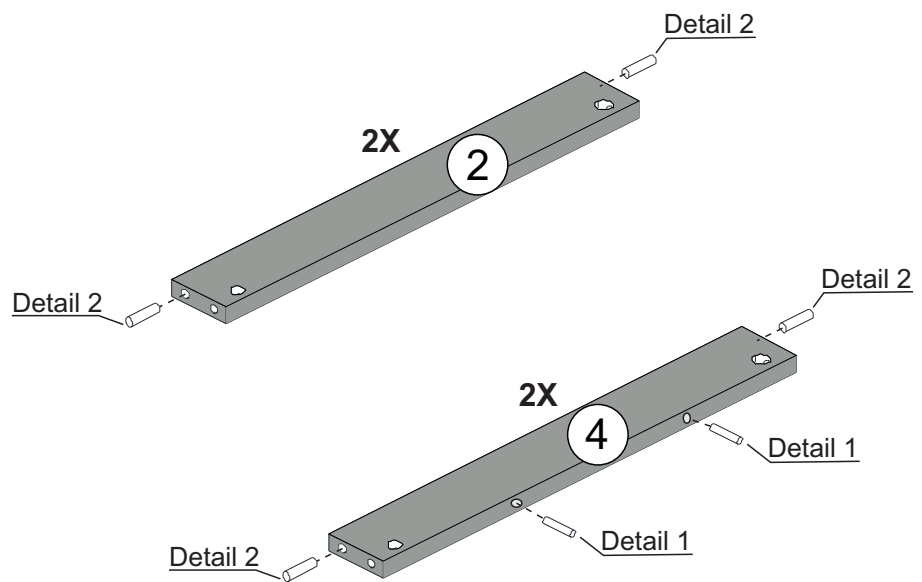
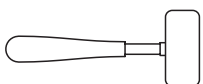

STEP 3

PARTS REQUIRED

8 - TOP PANEL x1

HARDWARE REQUIRED

G  04

TOOLS REQUIRED

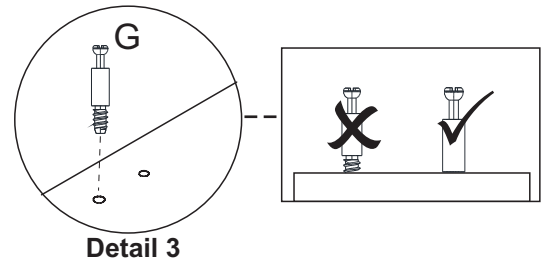
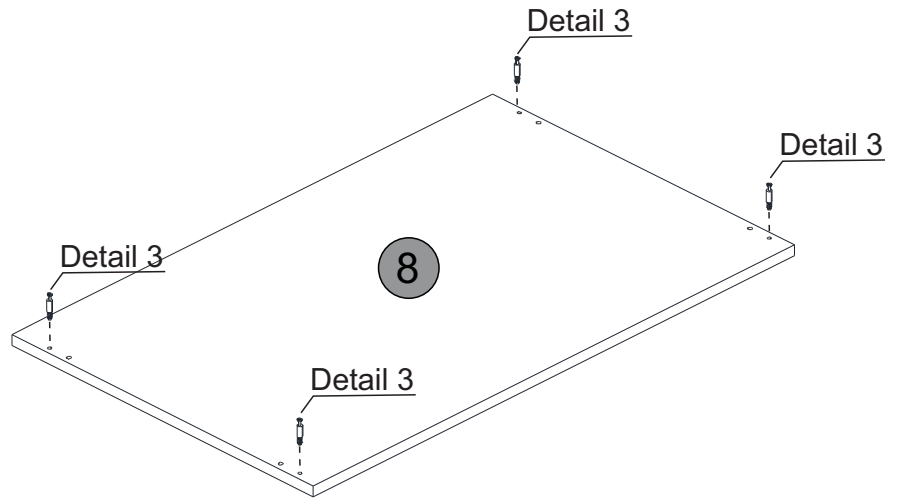
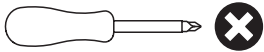

STEP 4

PARTS REQUIRED

7- RIGHT SIDE PANEL x1

HARDWARE REQUIRED

A  01

B  Ø6 x 30mm 04

TOOLS REQUIRED

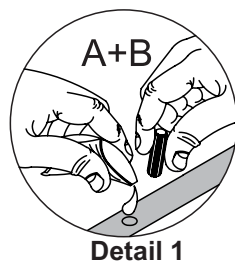
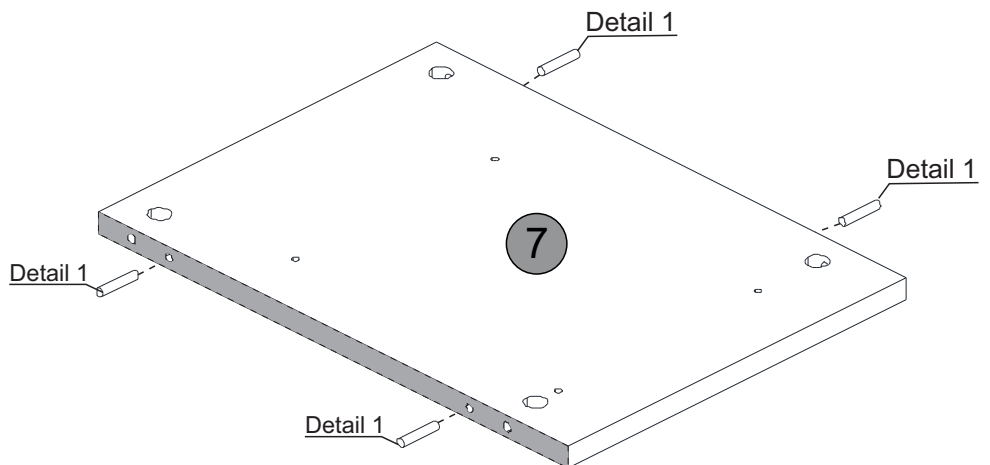
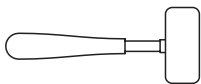

STEP 5

PARTS REQUIRED

7- RIGHT SIDE PANEL x1

HARDWARE REQUIRED

C  02
350mm

H  04
Ø6 x 8mm

TOOLS REQUIRED

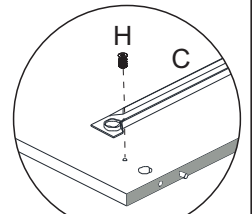
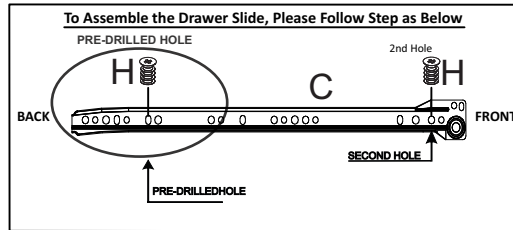
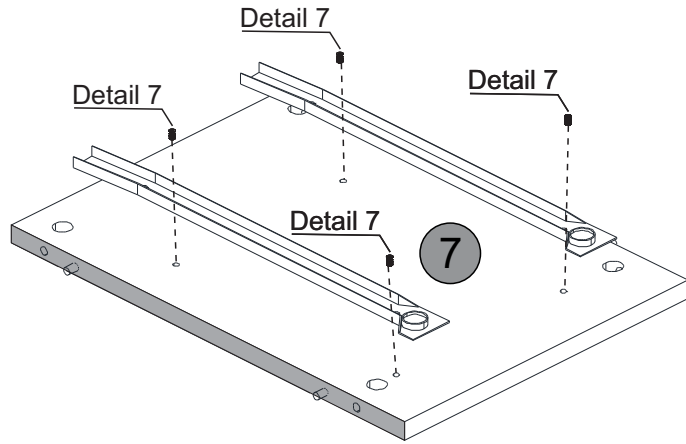

Detail 7

STEP 6

PARTS REQUIRED

6- LEFT SIDE PANEL x1

HARDWARE REQUIRED

A  01
Glue

B  04
Ø6 x 30mm

TOOLS REQUIRED

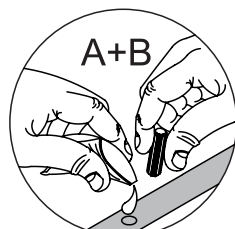
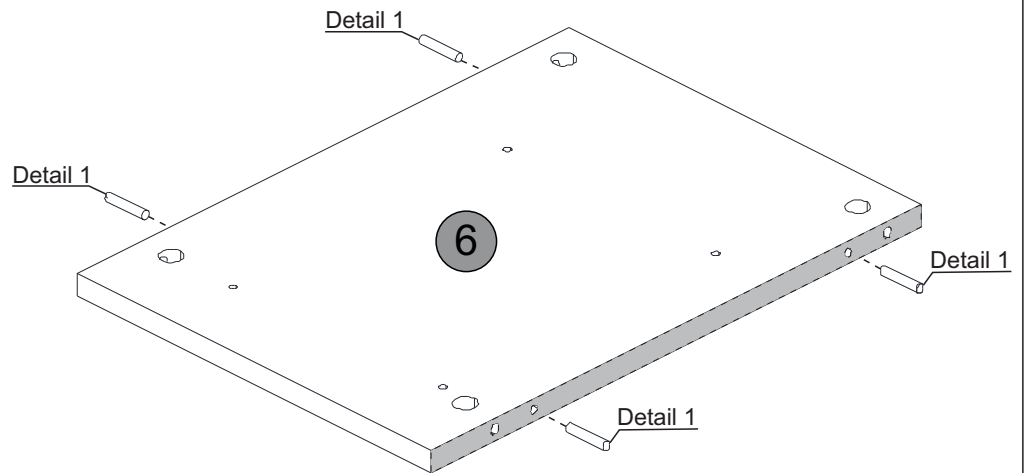
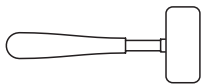

Detail 1

STEP 7

PARTS REQUIRED

6- Left Side Panel x1

HARDWARE REQUIRED

C  02
350mm

H  04
Ø6 x 8mm

TOOLS REQUIRED

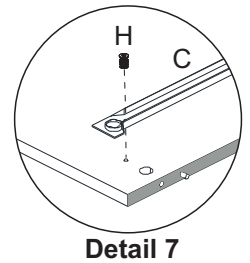
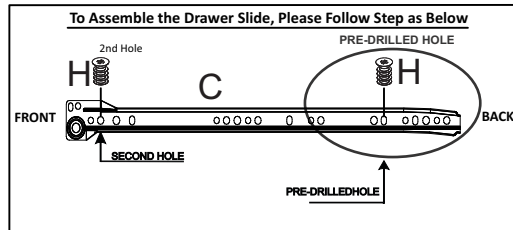
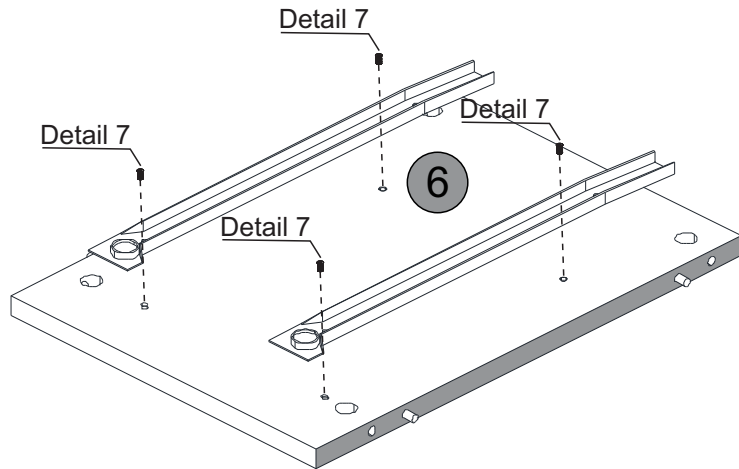
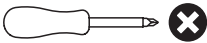

STEP 8

PARTS REQUIRED

1- LEFT LEG x2

3- LEG RIGHT x2

4- LEG SUPPORT FRONT & BACK x2

HARDWARE REQUIRED

A  01
Glue

L  04

TOOLS REQUIRED

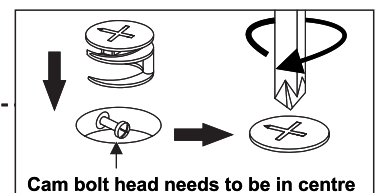
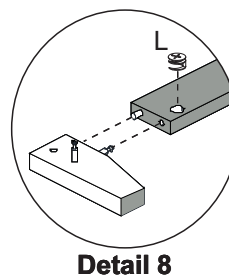
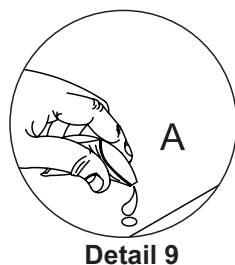
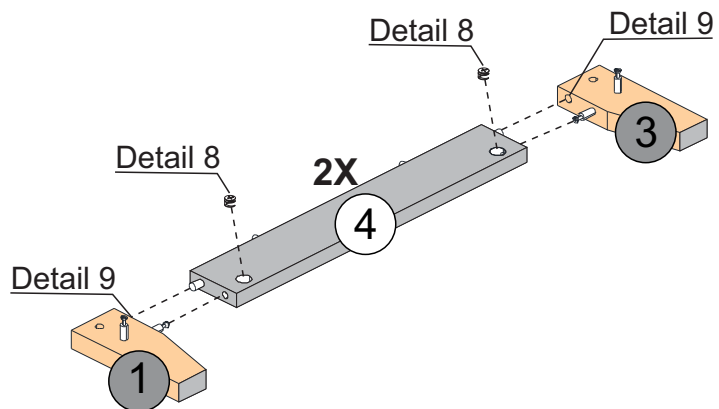
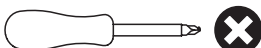

STEP 9

PARTS REQUIRED

2- SUPPORT LEFT & RIGHT x2

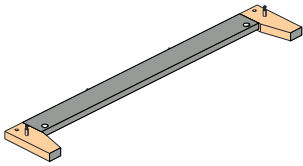

HARDWARE REQUIRED

A  01

L  02

TOOLS REQUIRED

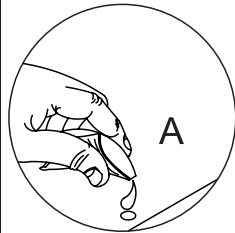
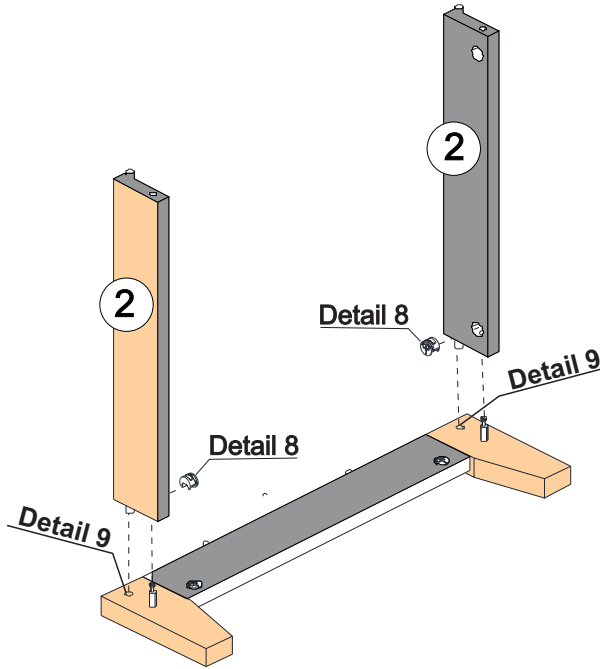
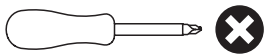

Detail 9

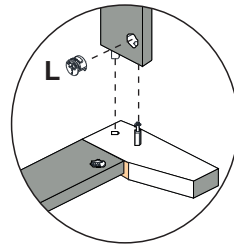

Detail 8

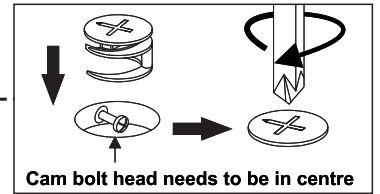

Cam bolt head needs to be in centre

STEP 10

PARTS REQUIRED

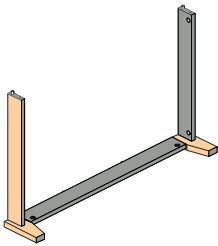

HARDWARE REQUIRED

A  01

L  02

TOOLS REQUIRED

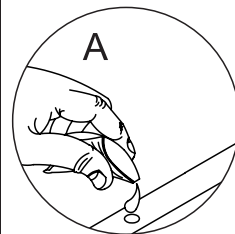
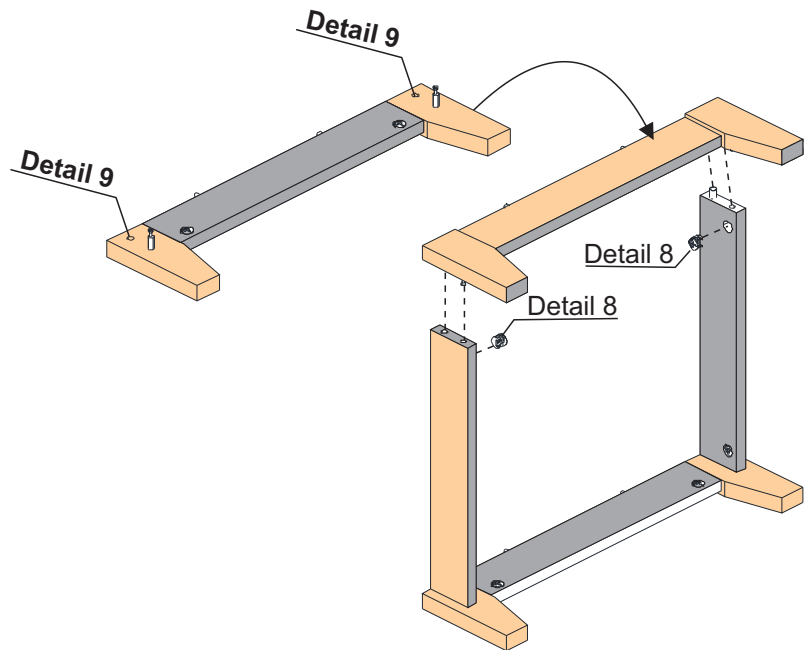
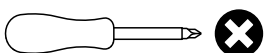

Detail 9

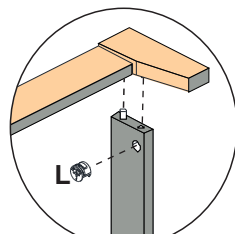

Detail 8

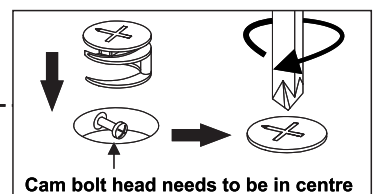

Cam bolt head needs to be in centre

STEP 11

PARTS REQUIRED

5- BASE PANEL x1

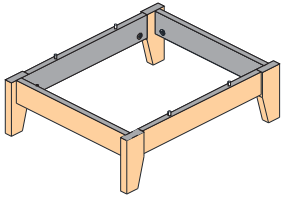

HARDWARE REQUIRED

A  01

D  Ø4,0 x 40mm 04

TOOLS REQUIRED

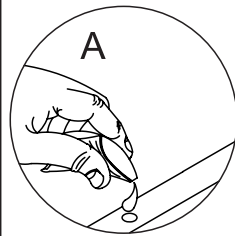
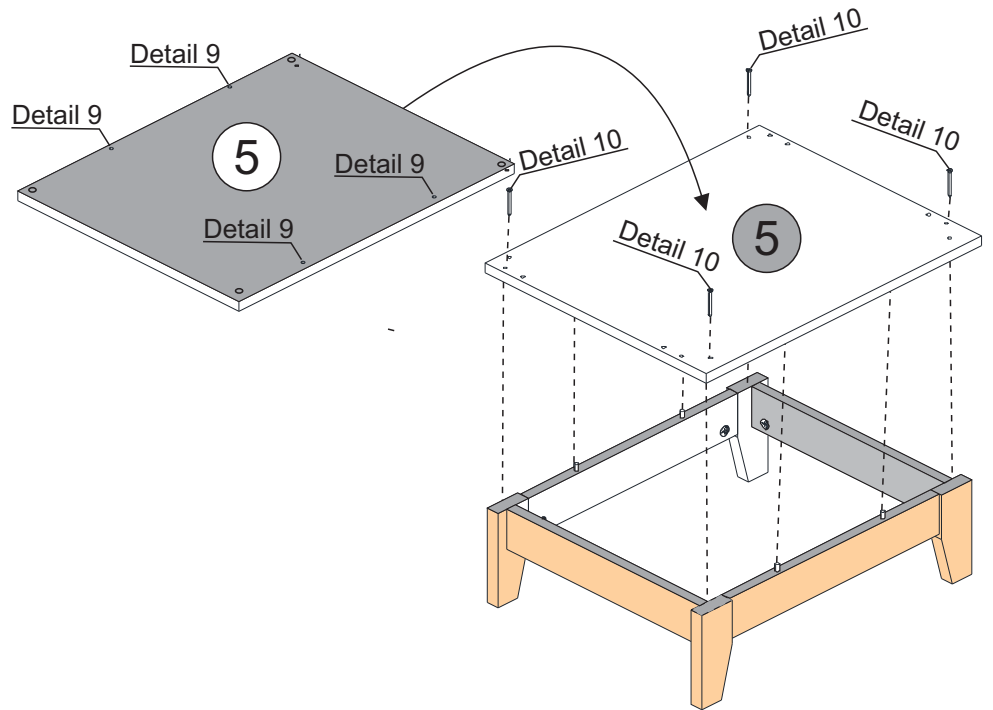
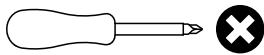

Detail 9

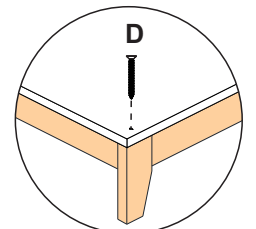

Detail 10

STEP 12

PARTS REQUIRED

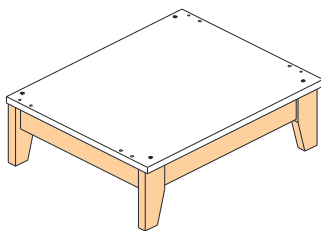

HARDWARE REQUIRED

G  04

TOOLS REQUIRED

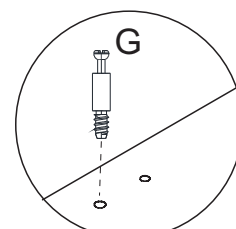
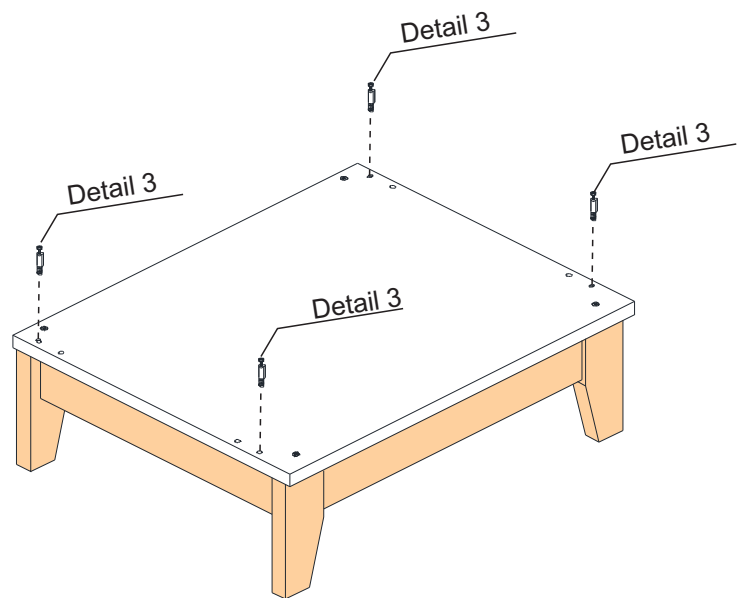
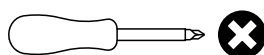

Detail 3

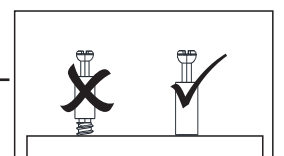

STEP 13

PARTS REQUIRED

6- LEFT SIDE PANEL x1

7- RIGHT SIDE PANEL x1

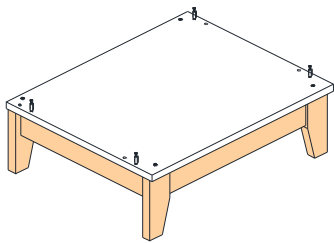

HARDWARE REQUIRED

A  01

L  04

TOOLS REQUIRED

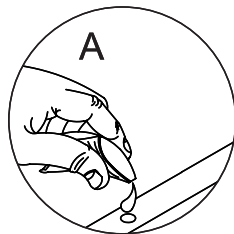
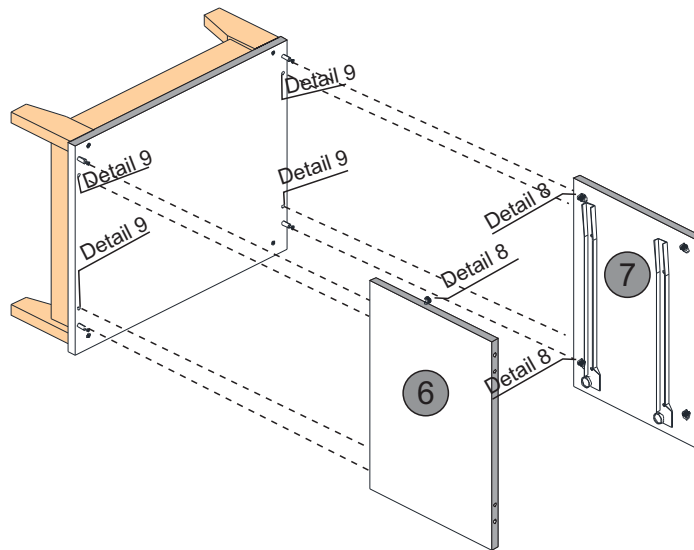
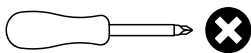

Detail 9

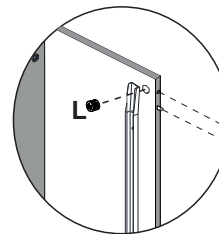

Detail 8

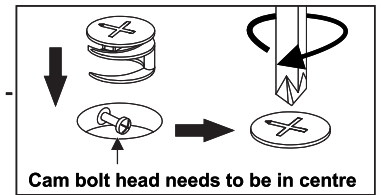

Cam bolt head needs to be in centre

STEP 14

PARTS REQUIRED

8 - TOP PANEL x1

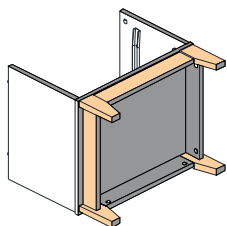

HARDWARE REQUIRED

A  01

L  04

TOOLS REQUIRED

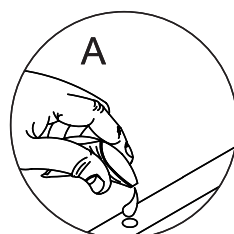
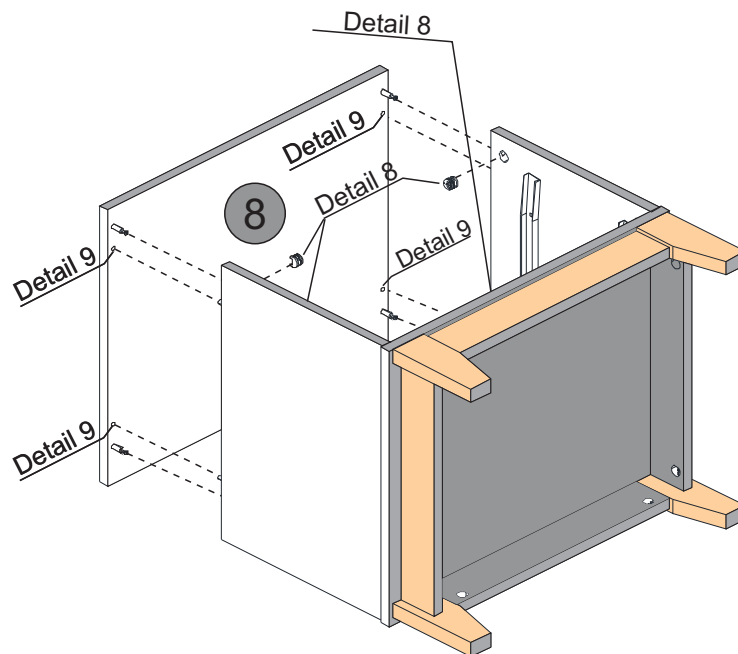
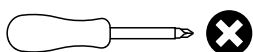

Detail 9

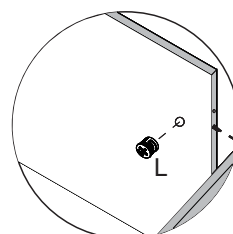

Detail 8

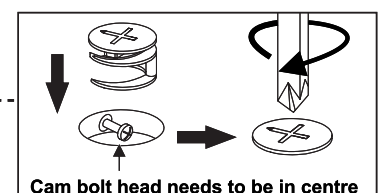

Cam bolt head needs to be in centre

STEP 15

PARTS REQUIRED

9 - BACK PANEL x1

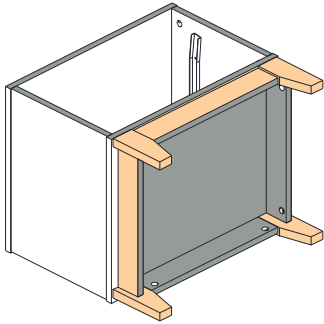

HARDWARE REQUIRED

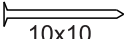
E  12
10x10

TOOLS REQUIRED

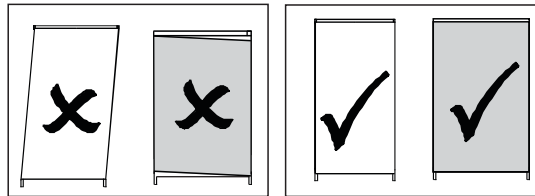
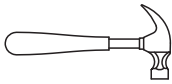

FOR YOUR REFERENCE
ORDER NUMBER
SHOULD BE HERE.

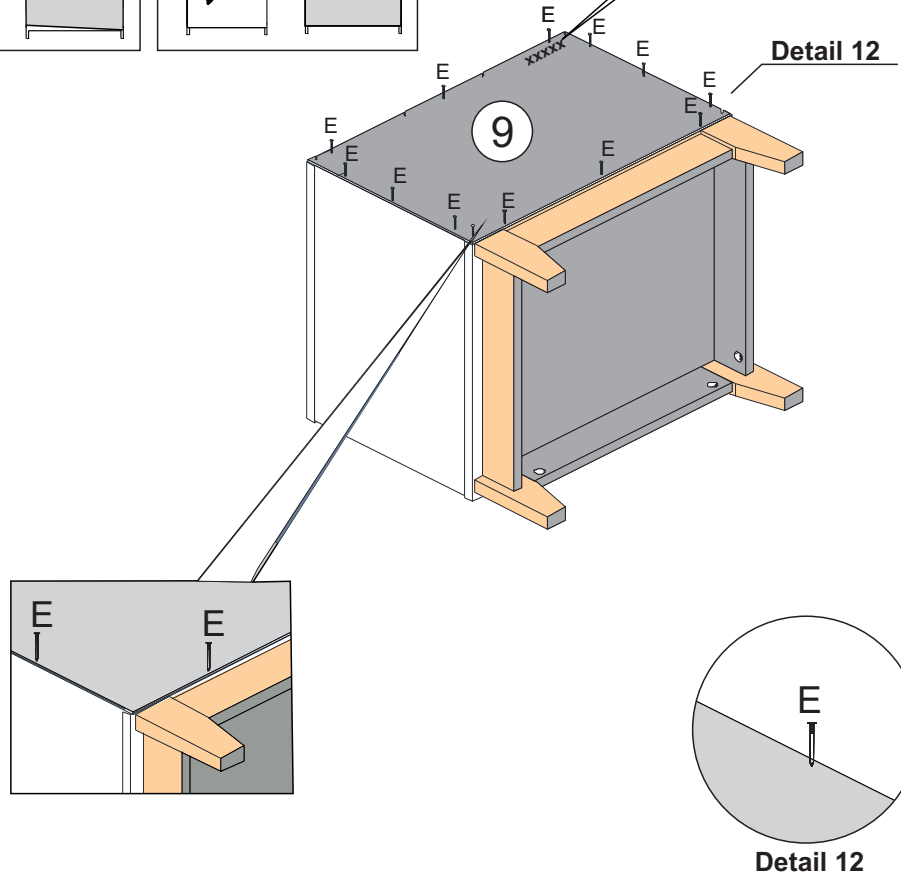

STEP 16

PARTS REQUIRED

13- DRAWER SIDE (LARGE) x2

15- DRAWER BACK (LARGE) x1

HARDWARE REQUIRED

A  01

B  08
Ø6 x 30mm

TOOLS REQUIRED

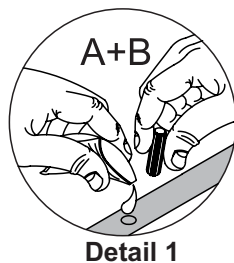
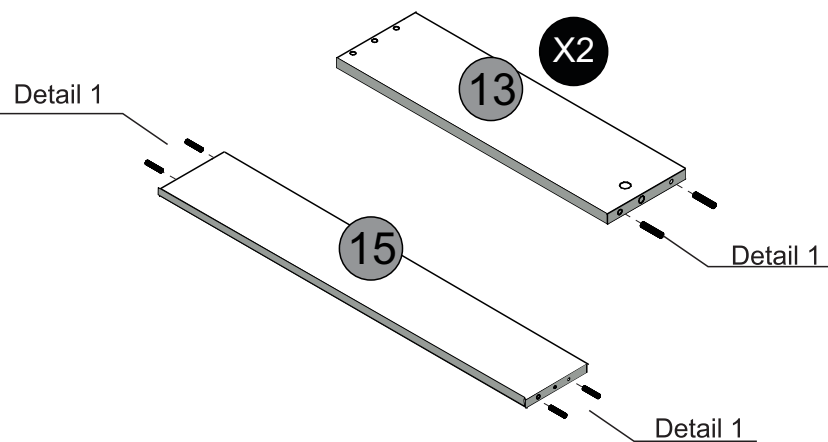
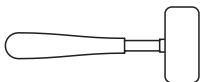

Detail 1

STEP 17

PARTS REQUIRED

16- DRAWER FRONT PINE x1

HARDWARE REQUIRED

G  02

TOOLS REQUIRED

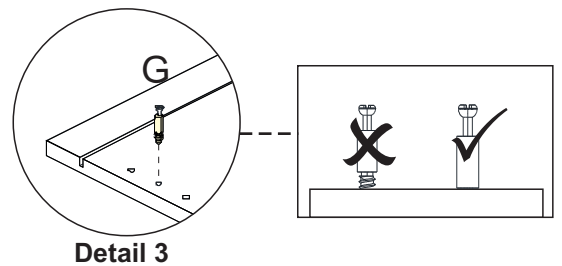
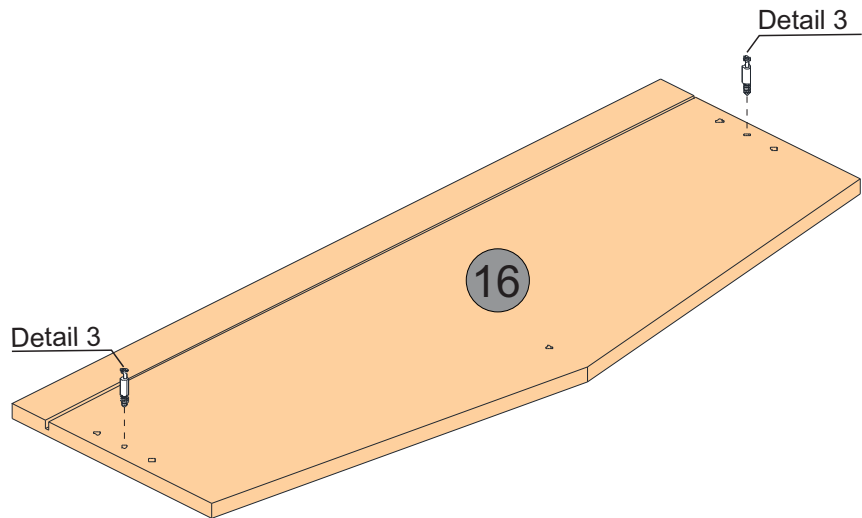
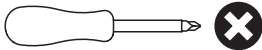

Detail 3

STEP 18

PARTS REQUIRED

13- DRAWER SIDE (LARGE) x2

15- DRAWER BACK (LARGE) x1

HARDWARE REQUIRED

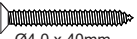
D  02
Ø4,0 x 40mm

A  01

TOOLS REQUIRED

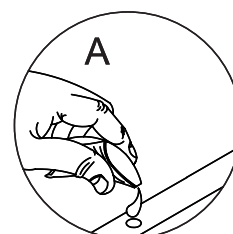
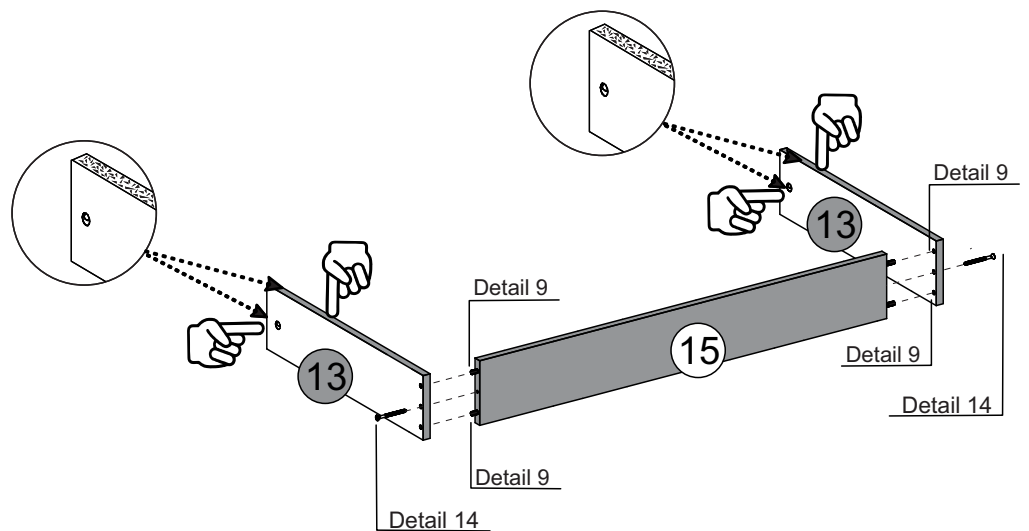
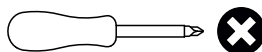

Detail 9

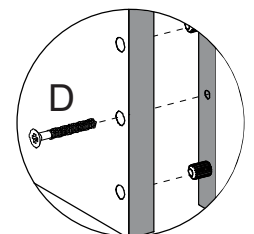

Detail 14



STEP 19

PARTS REQUIRED

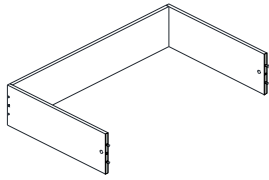
16 - DRAWER FRONT PINE x1



HARDWARE REQUIRED

- A  01
- F  Ø12mm 02
- J  02

TOOLS REQUIRED

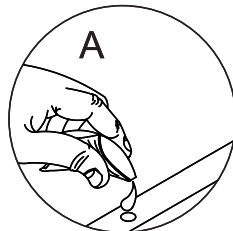
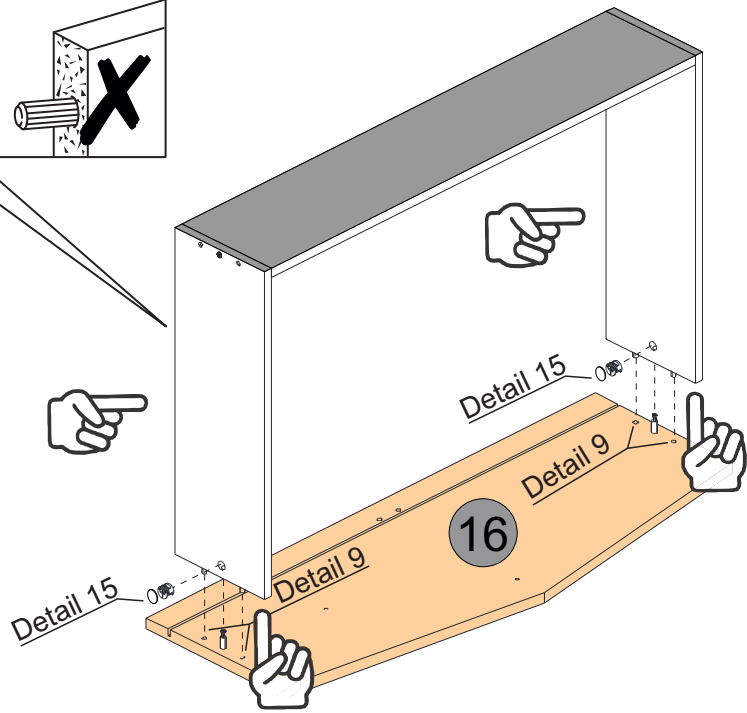
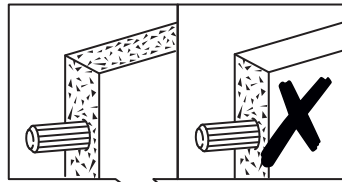
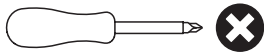

Detail 9

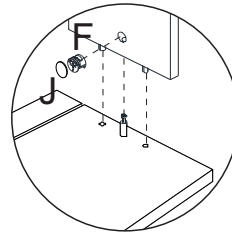

Detail 15

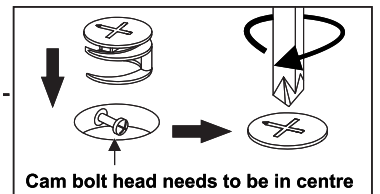

Cam bolt head needs to be in centre

STEP 20

PARTS REQUIRED

12 - DRAWER BASE x1

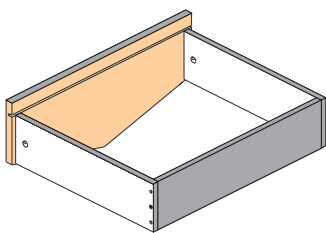

HARDWARE REQUIRED

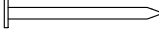
E  05

TOOLS REQUIRED

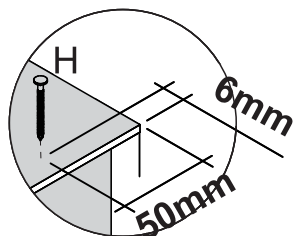
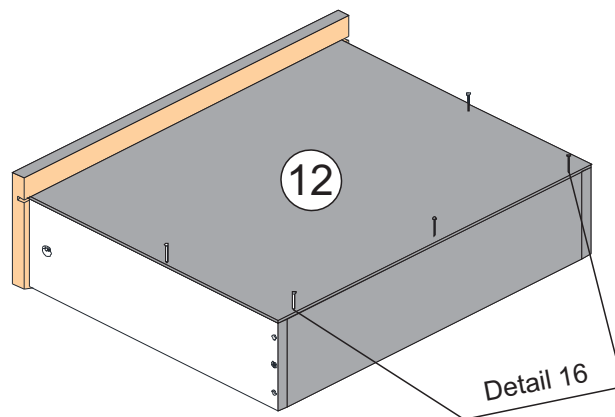
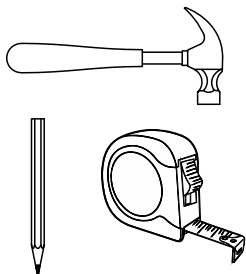

Detail 16

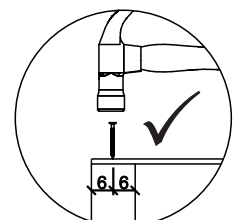
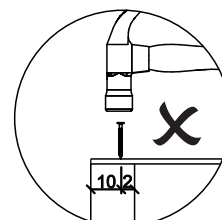
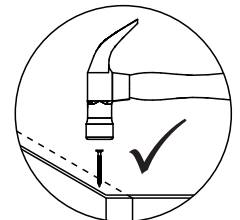
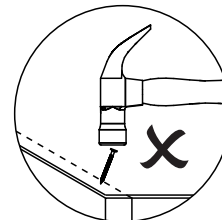

STEP 21

PARTS REQUIRED

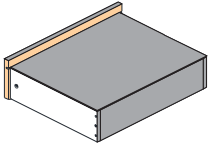

HARDWARE REQUIRED

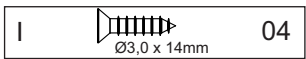
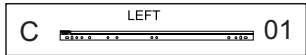

TOOLS REQUIRED

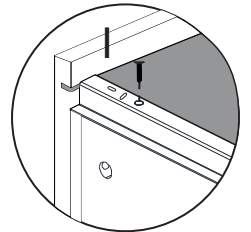
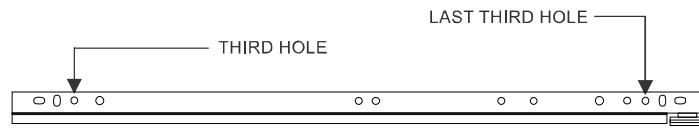
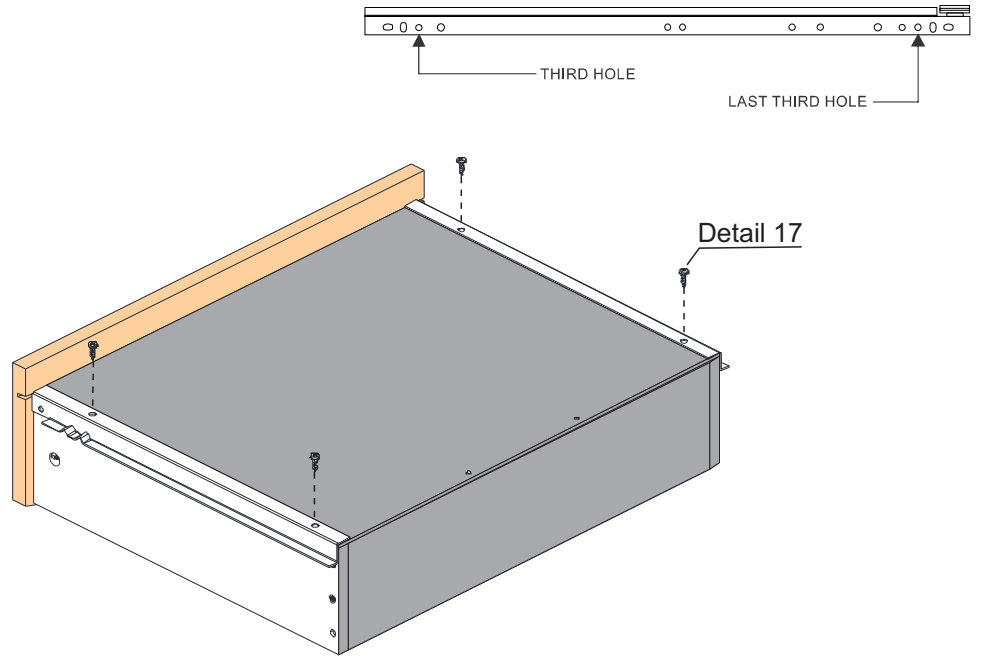
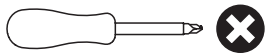

Detail 17

STEP 22

PARTS REQUIRED

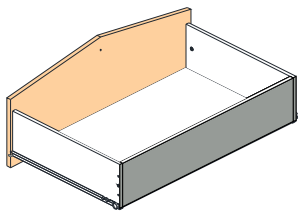

HARDWARE REQUIRED

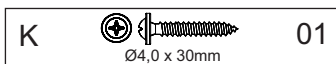
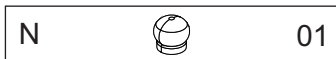

TOOLS REQUIRED

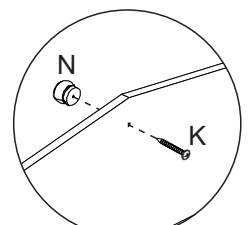
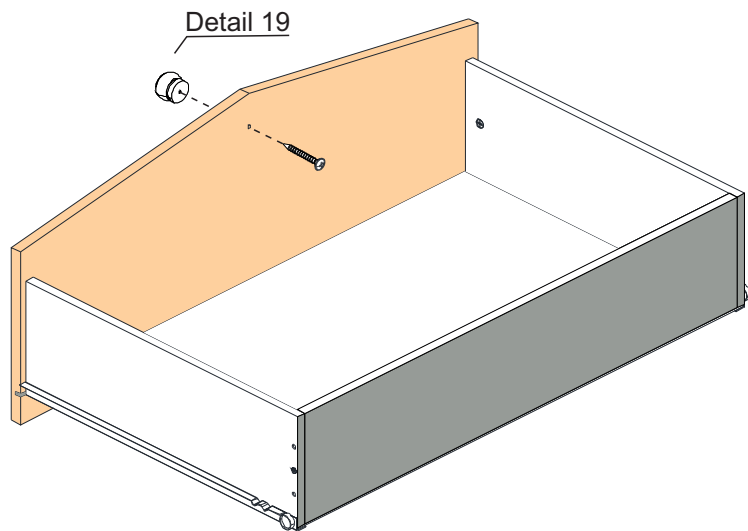
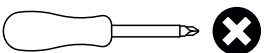

Detail 19

STEP 23

PARTS REQUIRED

10- DRAWER SIDE (SMALL) x2

11- DRAWER BACK (SMALL) x1

HARDWARE REQUIRED

A  01

B  Ø6 x 30mm 04

TOOLS REQUIRED

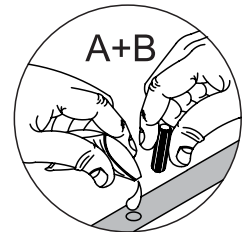
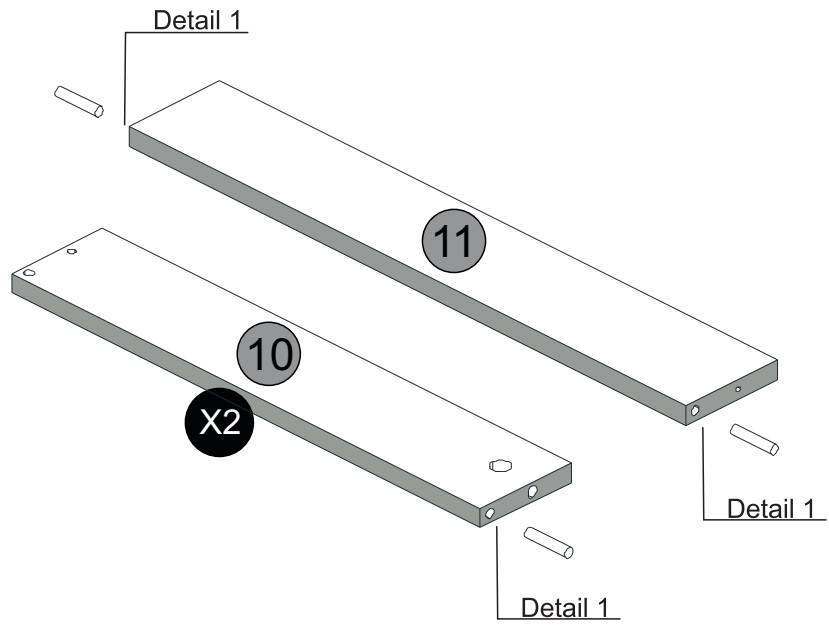
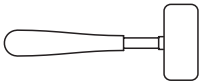

Detail 1

STEP 24

PARTS REQUIRED

14- DRAWER FRONT WHITE x1

HARDWARE REQUIRED

G  02

TOOLS REQUIRED

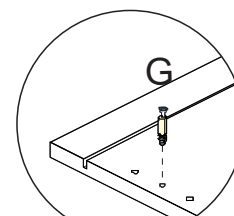
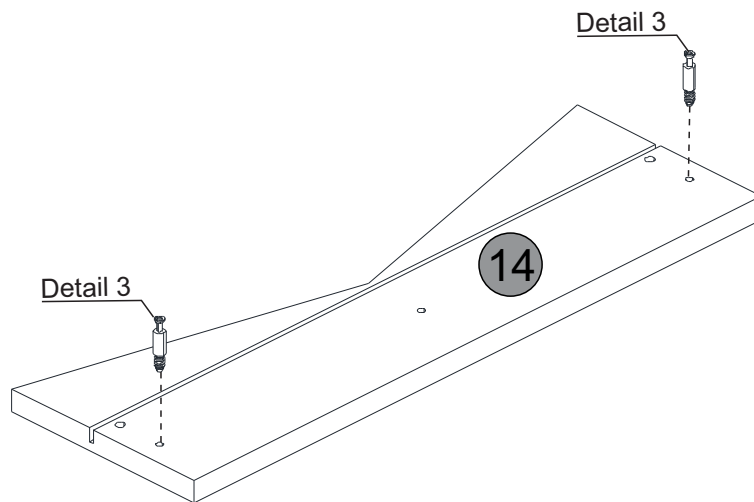
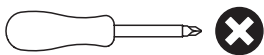

Detail 3

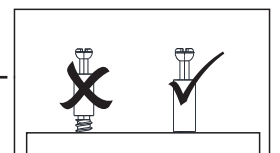

STEP 25

PARTS REQUIRED

10- DRAWER SIDE (SMALL) x2

11- DRAWER BACK (SMALL) x1

HARDWARE REQUIRED

A  01

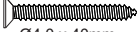
D  Ø4,0 x 40mm 02

TOOLS REQUIRED

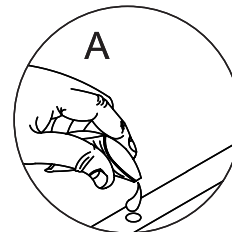
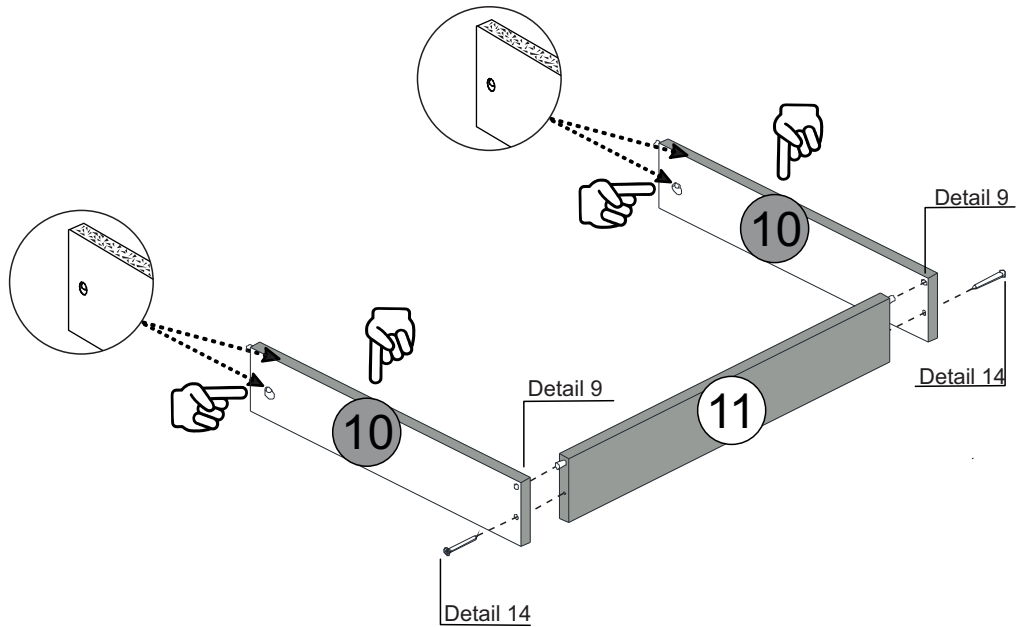
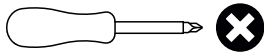

Detail 9

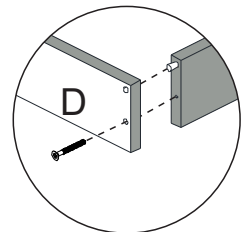

Detail 14

STEP 26

PARTS REQUIRED

16 - DRAWER FRONT PINE x1

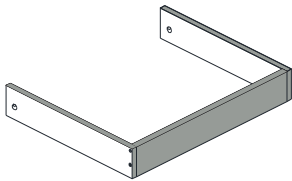

HARDWARE REQUIRED

A  01

F  Ø12mm 02

J  02

TOOLS REQUIRED

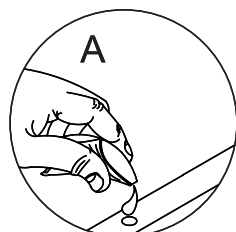
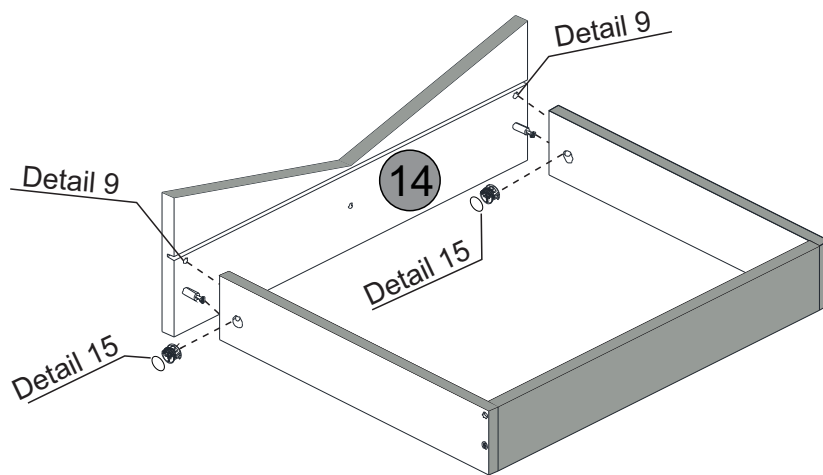
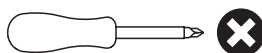

Detail 9

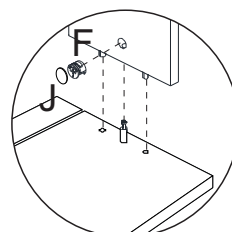

Detail 15

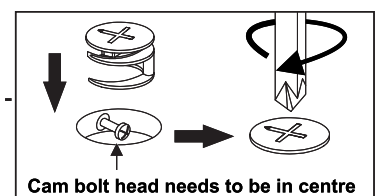

STEP 27

PARTS REQUIRED

12 - DRAWER BASE x1

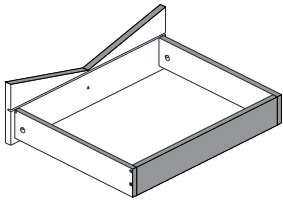

HARDWARE REQUIRED

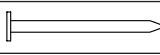
E  05

TOOLS REQUIRED

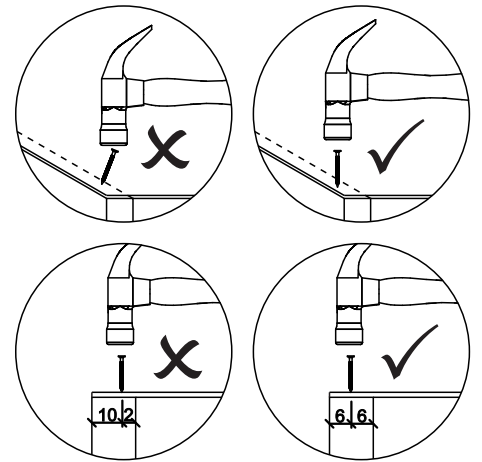
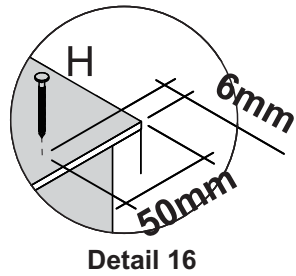
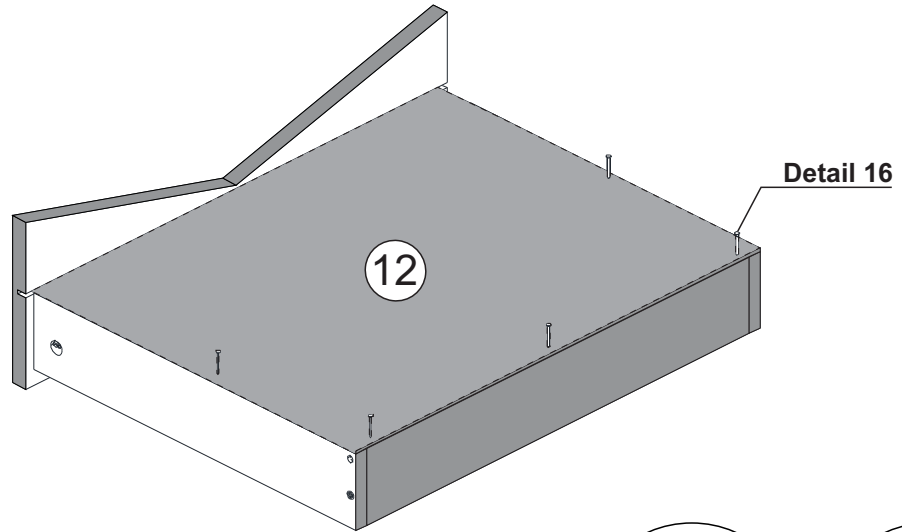
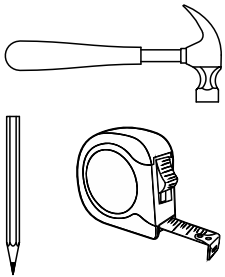

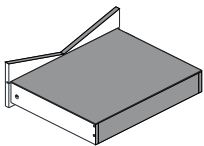

STEP 28

PARTS REQUIRED

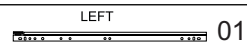
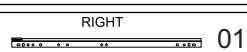

HARDWARE REQUIRED

C  LEFT 01
 C  RIGHT 01
 I  Ø3,0 x 14mm 04

TOOLS REQUIRED

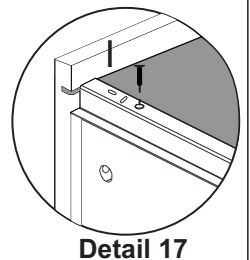
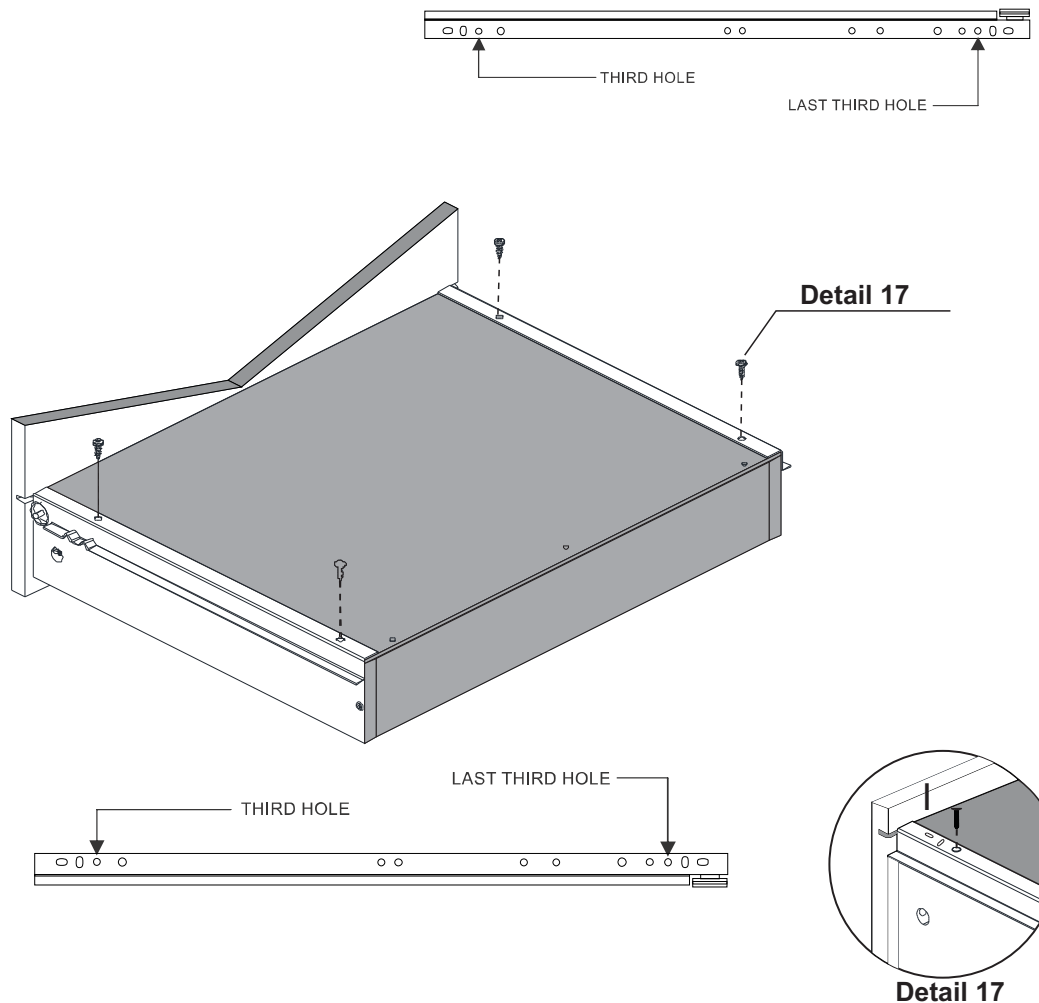
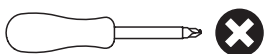

STEP 29

PARTS REQUIRED

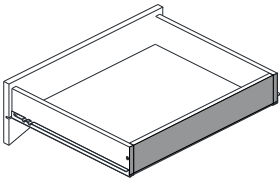

HARDWARE REQUIRED

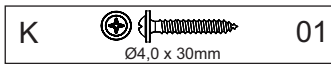

TOOLS REQUIRED

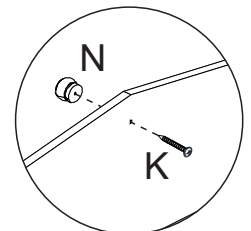
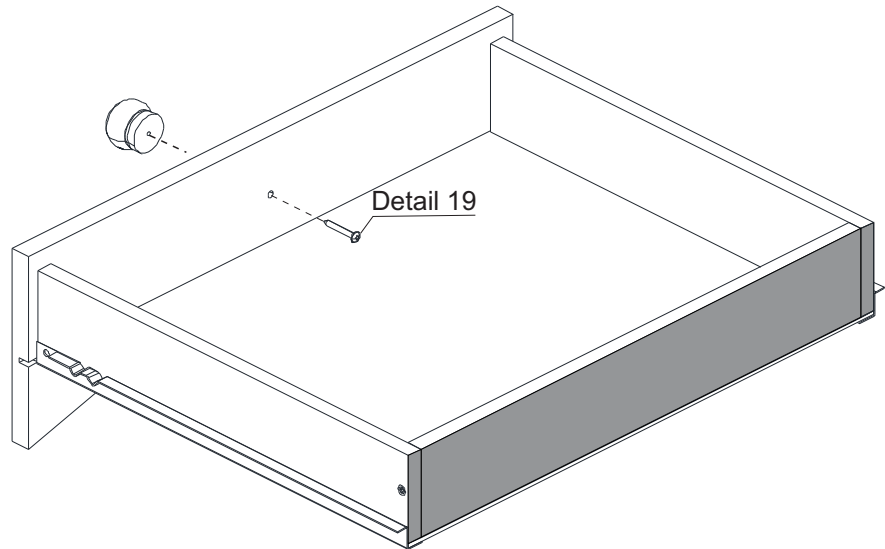
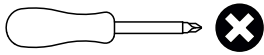

Detail 19

STEP 30

PARTS REQUIRED

