

NEVADA 3 DOOR 2 DRAWER WARDROBE ASSEMBLY INSTRUCTIONS

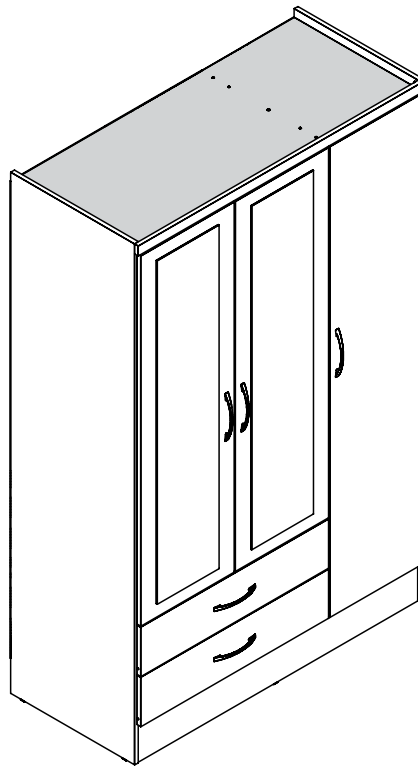

IMPORTANT **FOR DOMESTIC USE ONLY** PLEASE READ BEFORE YOU CONTINUE FURTHER **CARE AND MAINTENANCE**

After unpacking this product please keep the original packaging in case it needs to be returned for any reason.

- Please ensure all fittings and parts are present before commencing with assembly.
- Never drag or push products as this could cause damage to the joints making it inferior.
- We strongly recommend that you keep children away from your work area.
- We recommend that you lay a blanket or sheet on the floor to avoid damage to both your floor and the product.
- Assemble this product as close to its final position as possible.
- Do not place this product next to a radiator or in direct sunlight.
- Do not drag or push items across your high gloss furniture as this may cause the surface to scratch
- Wood is a natural product and may expand if subjected to damp and may shrink or crack if subjected to heat. Therefore it is recommended that room temperature is maintained, with no sudden temperature fluctuations.
- Make sure any spillage is wiped off immediately.
- Do not place hot or chilled items directly on to the surface, use a place mat or marking will occur.
- For general cleaning use a soft cotton or micro fibre cloth, and do not use detergents of any kind.
- From time to time it may be necessary to tighten fittings, regular inspections should be carried out.
- Do not place on a wet or damp floor as staining may occur to your floor.

TOOLS REQUIRED

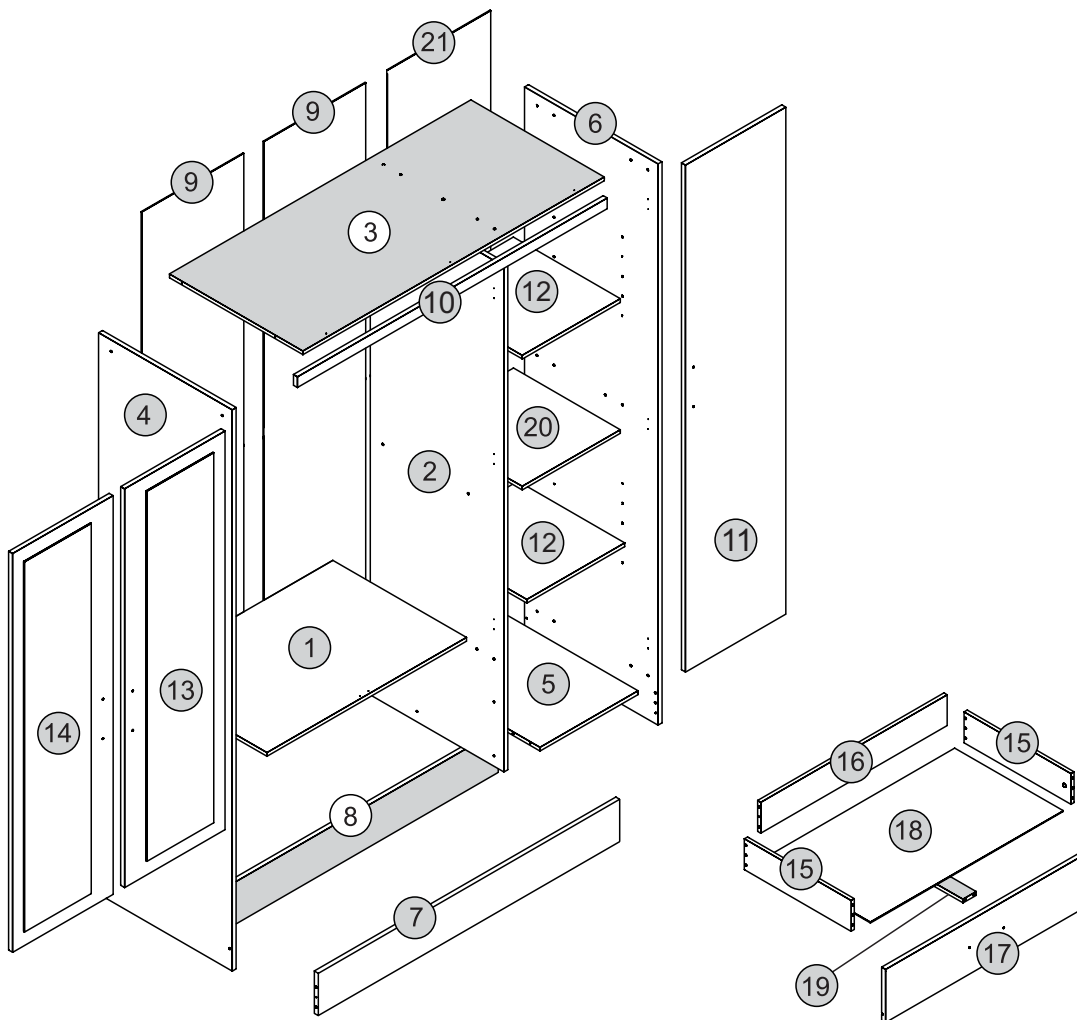
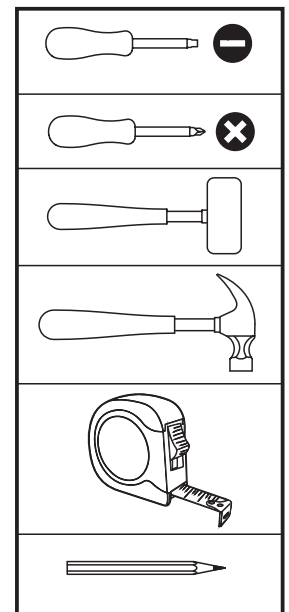









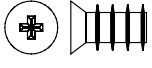
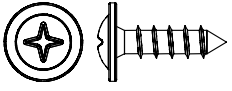

PARTS LIST

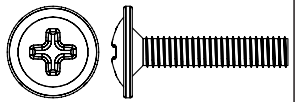
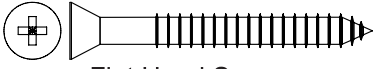
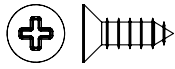
Please Note:

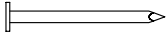
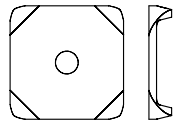
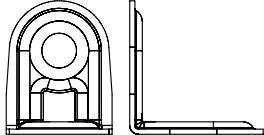
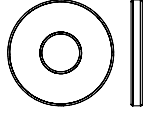
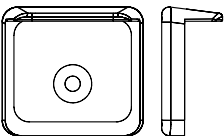
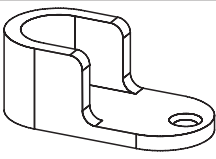
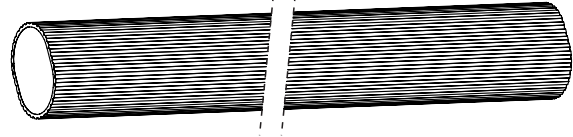
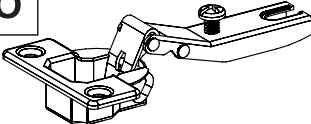
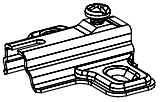
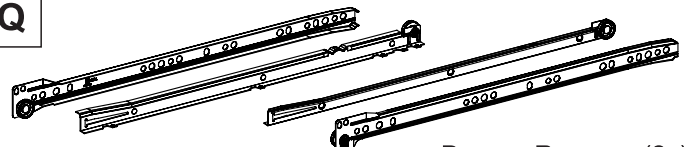
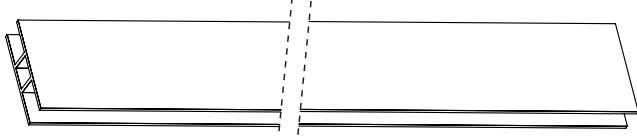
The below parts have all been stamped with the part number to help identify them during assembly.

Part Number	Part Description	Quantity	Carton
1	Large Base Panel	1	2/3
2	Division Panel	1	1/3
3	Top Panel	1	2/3
4	Left Side Panel	1	1/3
5	Small Base Panel	1	2/3
6	Right Side Panel	1	1/3
7	Front Baseboard	1	2/3
8	Back Baseboard	1	2/3
9	Small Back Panel	2	3/3
10	Frame	1	2/3
11	Large Door	1	3/3
12	Movable Shelf	2	2/3
13	Right Small Door	1	3/3
14	Left Small Door	1	3/3
15	Drawer Side	4	2/3
16	Drawer Back Panel	2	2/3
17	Drawer Front	2	2/3
18	Drawer Bottom	2	1/3
19	Drawer Bottom Support Bar	2	2/3
20	Shelf	1	2/3
21	Large Back Panel	1	3/3

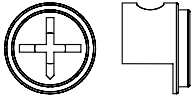
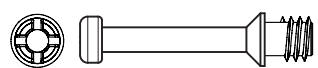
FITTINGS LIST

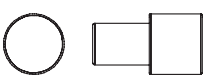
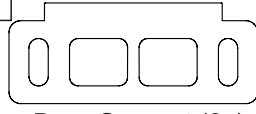
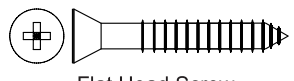
<p>A</p>  <p>Flat Head Screw Ø6,0 x 8mm (8x)</p> <p>1/+</p>	<p>B</p>  <p>Flan Head Screw Ø3,5 x 12mm (13x)</p> <p>2/+</p>	<p>C</p>  <p>Flat Head Screw Ø4,0 x 14mm (48x)</p> <p>2/+</p>	<p>D</p>  <p>Flan Head Screw Ø4,0 x 20mm (10x)</p> <p>2/+</p>
<p>E</p>  <p>Flat Head Screw Ø4,0 x 45mm(28x)</p> <p>2/+</p>	<p>F</p>  <p>Flat Head Screw Ø4,0 x 12mm (14x)</p> <p>2/+</p>		<p>G</p>  <p>2/+ Dowel Ø6,0 x 30mm (46x)</p>
<p>H</p>  <p>4/+ Nail 10 x 10 (86x)</p>	<p>I</p>  <p>2/+ Back Panel Bracket (14x)</p>	<p>J</p>  <p>1/+ 'L' Metallic Support (5x)</p>	<p>K</p>  <p>1/+ Washer (4x)</p>
<p>L</p>  <p>1/+ Plastic Foot (6x)</p>	<p>M</p>  <p>Hanging Rail Support (2x)</p>	<p>N</p>  <p>Hanging Rail (1x)</p>	
<p>O</p>  <p>Hinge (9x)</p>	<p>P</p>  <p>Hinge Plate (9x)</p>	<p>Q</p>  <p>Drawer Runners (2x)</p>	
<p>R</p>  <p>Back Panel Strip (1x)</p>		<p>S</p>  <p>Strap (2x)</p>	<p>T</p>  <p>Handle (5x)</p>
<p>U</p>  <p>2/+ Hole Plugs (30x)</p>	<p>V</p>  <p>Glue (2x)</p>	<p>W</p>  <p>1/+ Cam Nut (4x)</p>	<p>X</p>  <p>1/+ Cam Bolt (4x)</p>
<p>Y</p>  <p>Flan Head Screw Ø3,5 x 30mm (2x)</p> <p>1/+</p>	<p>Z</p>  <p>Support Pin (8x)</p> <p>1/+</p>	<p>A1</p>  <p>Door Support (2x)</p>	<p>A2</p>  <p>Flat Head Screw Ø3,5 x 25mm (2x)</p> <p>1/+</p>

TIPS FOR FITTINGS CAM-LOCKS

WHEN FITTING CAM NUT, ENSURE STARTING POSITION IS CORRECT BEFORE YOU INSERT CONNECTING CAM BOLT TURN CLOCKWISE UNTIL SECURE

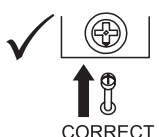

✓

↑

CORRECT



✗

↑

WRONG

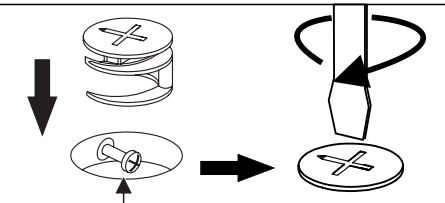

Cam bolt head needs to be in centre

CAMBOLT

Tighten until shoulder in flush with panel. Do not overtighten or undertighten (see example beside)

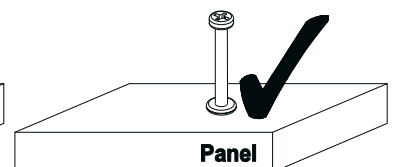
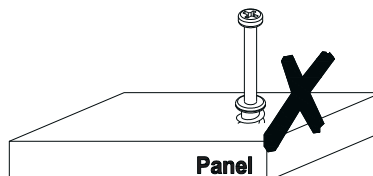
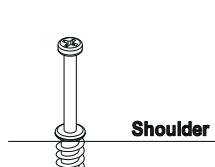

STEP 1

PARTS REQUIRED

2 - DIVISION PANEL x1

HARDWARE REQUIRED

G  04
Ø6,0 x 30mm

V  01
Glue

Z  04

TOOLS REQUIRED

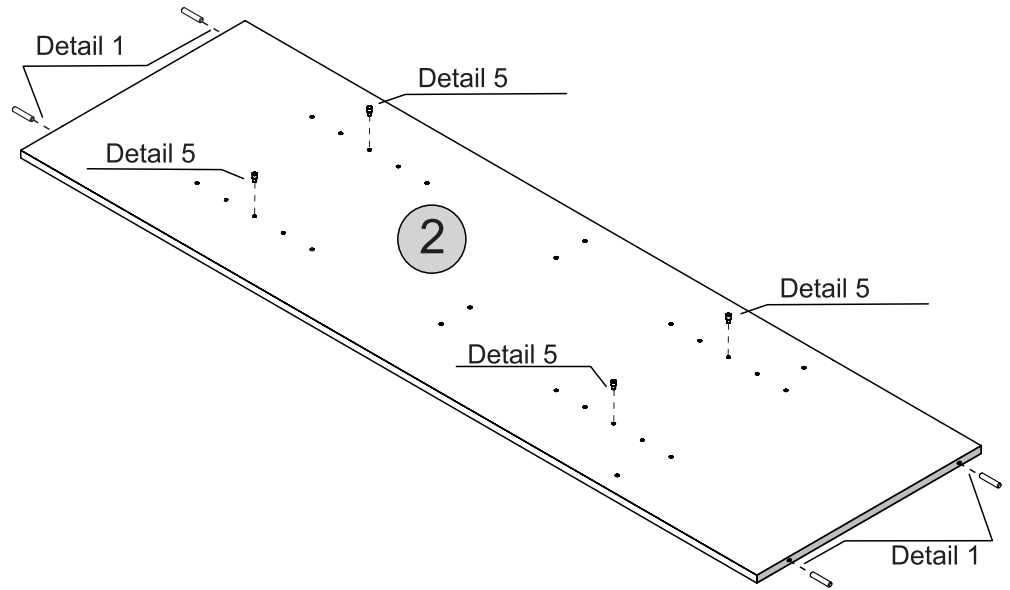
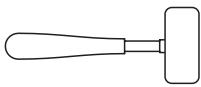

Detail 1

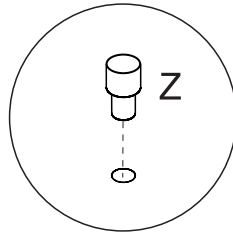

Detail 5

STEP 2

PARTS REQUIRED

2 - DIVISION PANEL x1

HARDWARE REQUIRED

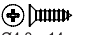
C  08
Ø4,0 x 14mm

M  01

P  03

TOOLS REQUIRED

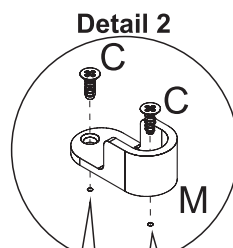
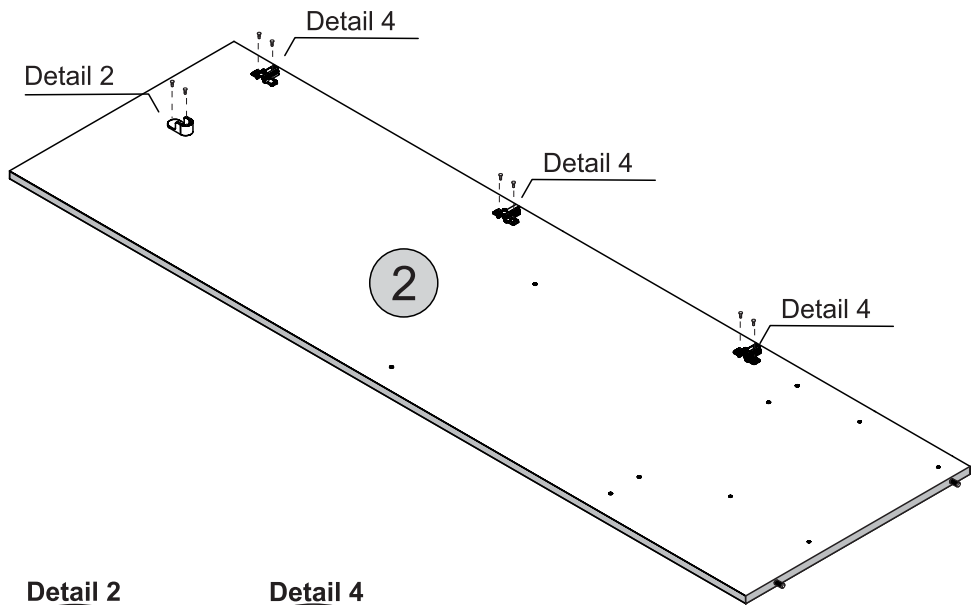
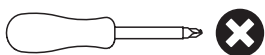

Please note:
Pre-marked
Holes

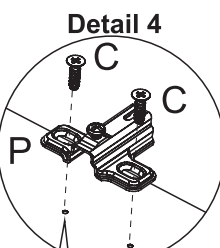

Please note:
Pre-marked
Holes

STEP 3

PARTS REQUIRED

2 - DIVISION PANEL x1

HARDWARE REQUIRED

A  04
Ø6,0 x 8mm

Q  02
Right

TOOLS REQUIRED

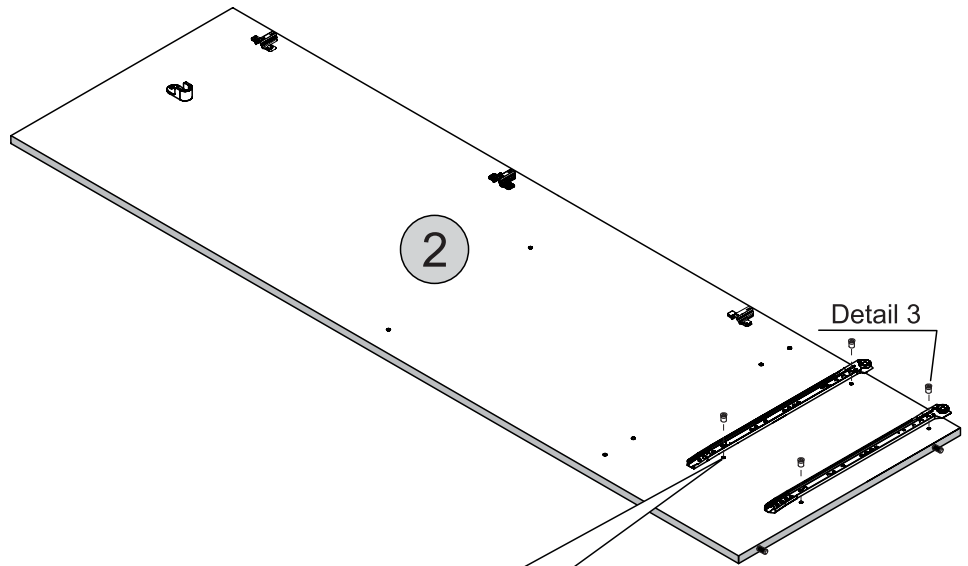

PLEASE NOTE
PRE-DRILLED
HOLES.

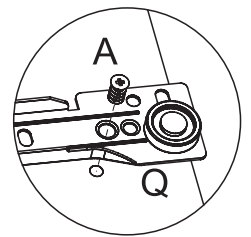
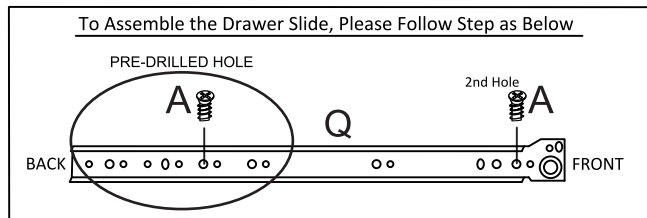

Detail 3

STEP 4

PARTS REQUIRED

4 - LEFT SIDE PANEL x1

HARDWARE REQUIRED

C  08
Ø4,0 x 14mm

M  01

P  03

TOOLS REQUIRED

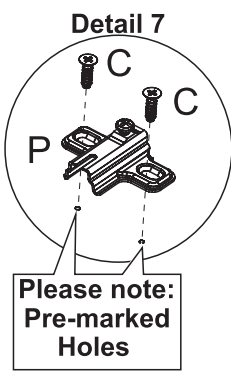
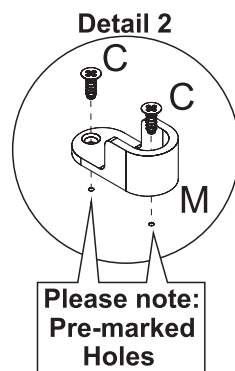
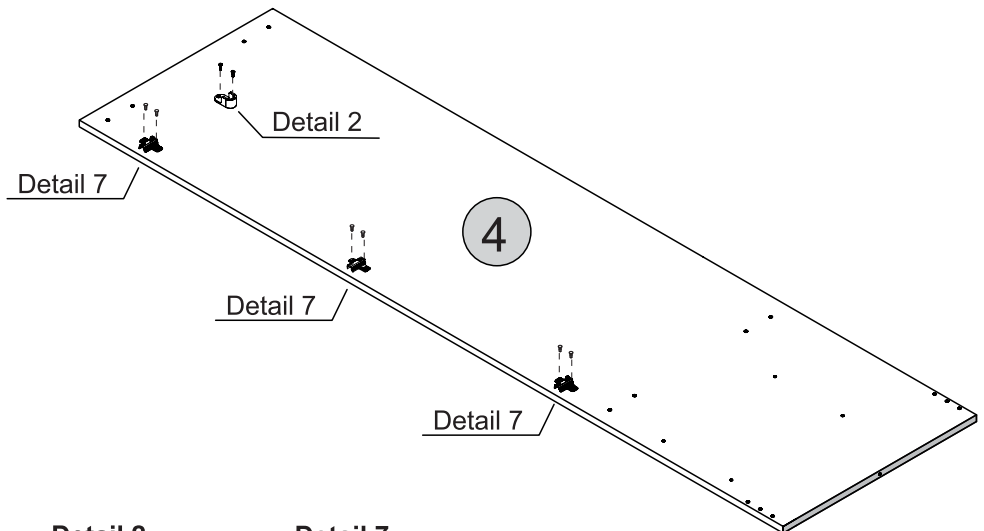
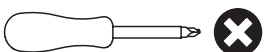





STEP 5

PARTS REQUIRED

4 - LEFT SIDE PANEL x1

HARDWARE REQUIRED

- A  04
Ø6,0 x 8mm
- H  02
- L  02
- Q  02

TOOLS REQUIRED

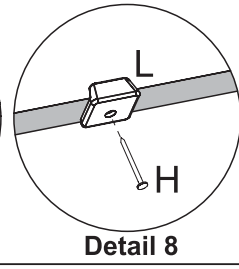
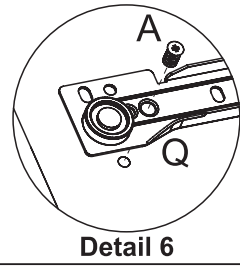
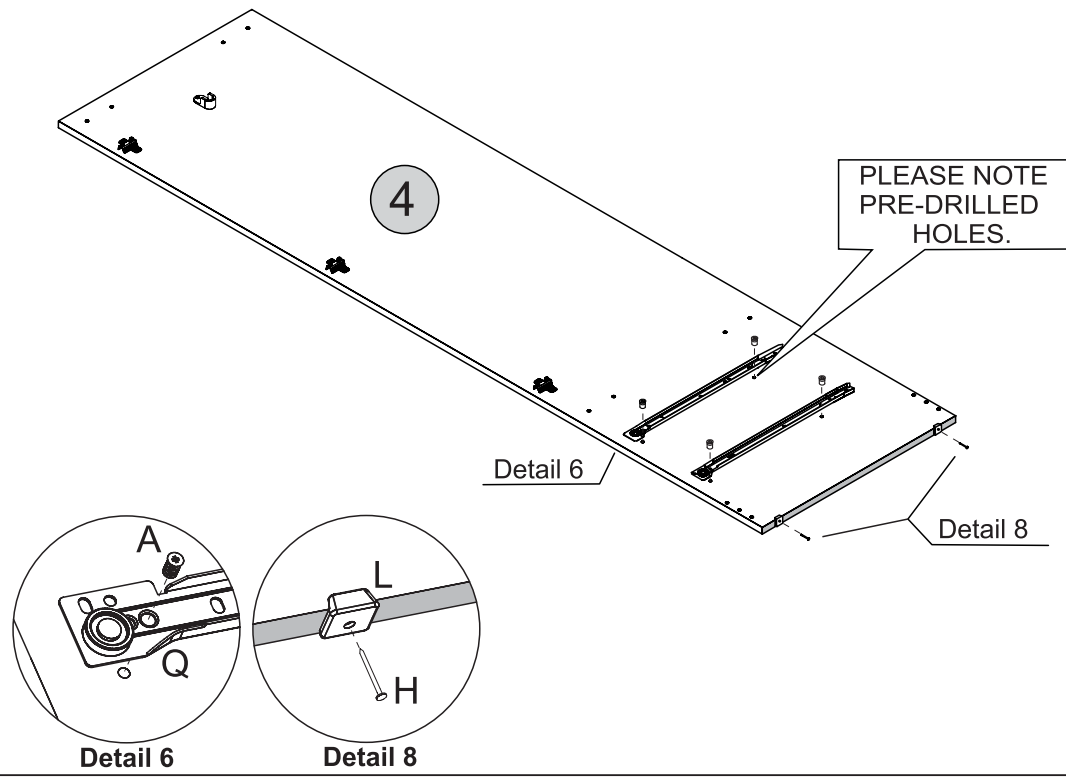
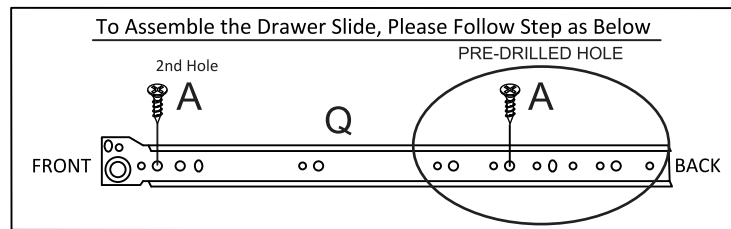
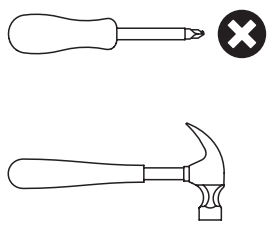



STEP 6

PARTS REQUIRED

6 - RIGHT SIDE PANEL x1

HARDWARE REQUIRED

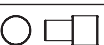
- C  06
Ø4,0 x 14mm
- P  03
- Z  04

TOOLS REQUIRED

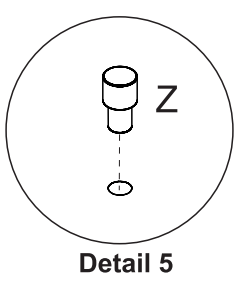
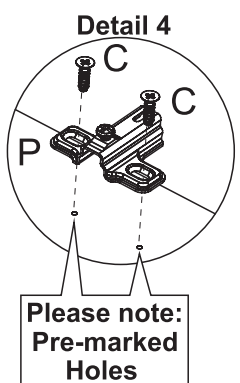
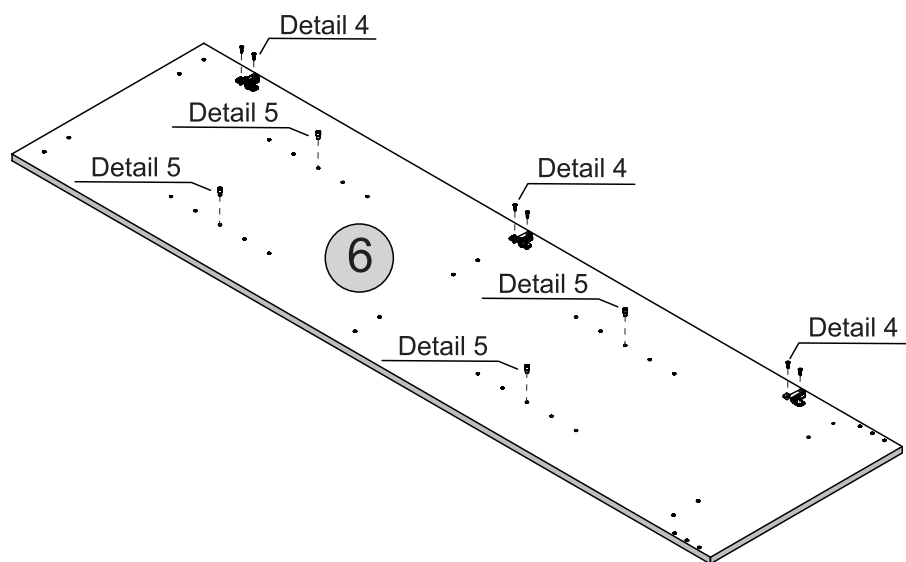
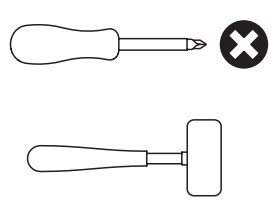





Please note: Pre-marked Holes

STEP 7

PARTS REQUIRED

- 6 - RIGHT SIDE PANEL x1
- 7 - FRONT BASEBOARD x1
- 8 - BACK BASEBOARD x1

HARDWARE REQUIRED

- G  Ø6,0 x 30mm 08
- H  10 x 10 04
- L  04
- V  Glue 01

TOOLS REQUIRED

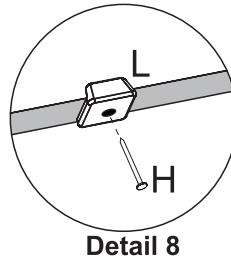
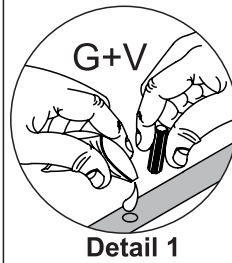
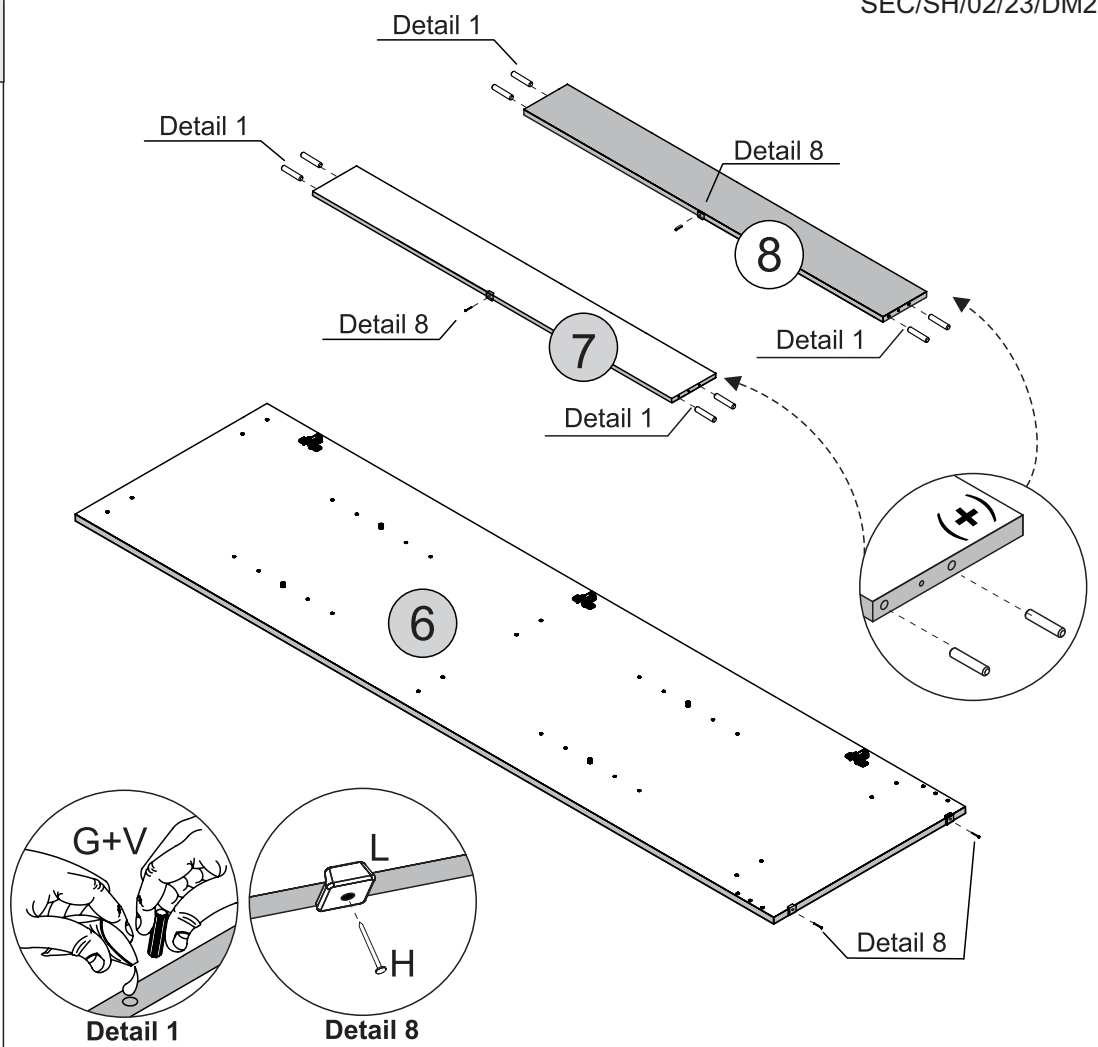
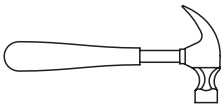



STEP 8

PARTS REQUIRED

- 1 - LARGE BASE PANEL x1
- 3 - TOP PANEL x1
- 5 - SMALL BASE PANEL x1
- 20 - SHELF x1

HARDWARE REQUIRED

- G  Ø6,0 x 30mm 14
- V  Glue 01

TOOLS REQUIRED

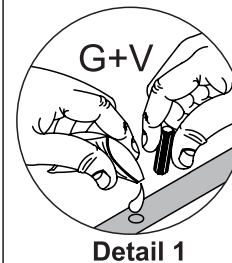
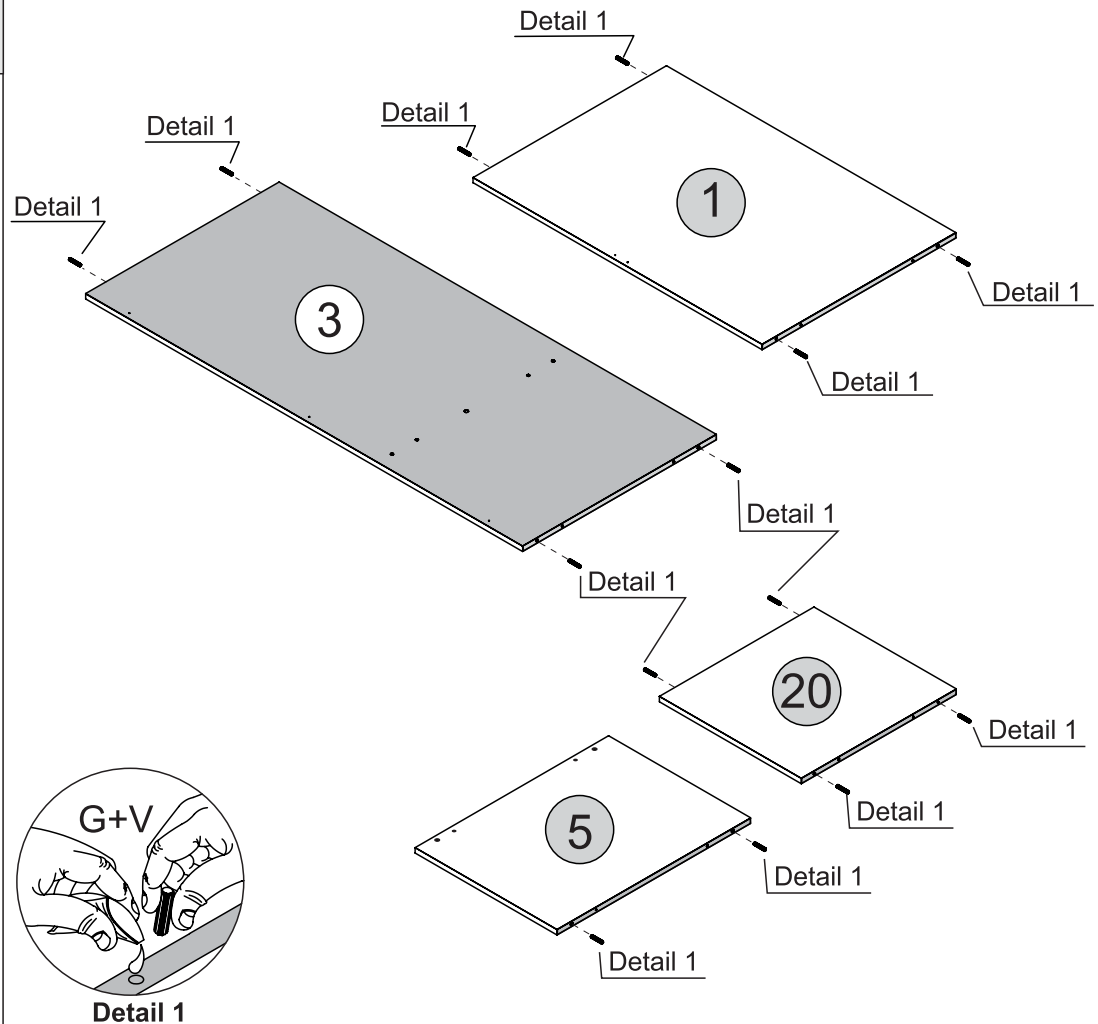
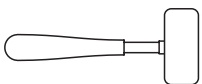

STEP 9

PARTS REQUIRED

1 - LARGE BASE PANEL x1

3 - TOP PANEL x1

HARDWARE REQUIRED

B  04
Ø3,5 x 12mm

F  03
Ø4,0 x 12mm

A1  02

J  03

TOOLS REQUIRED

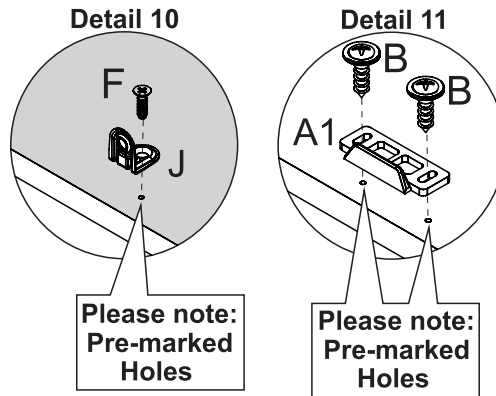
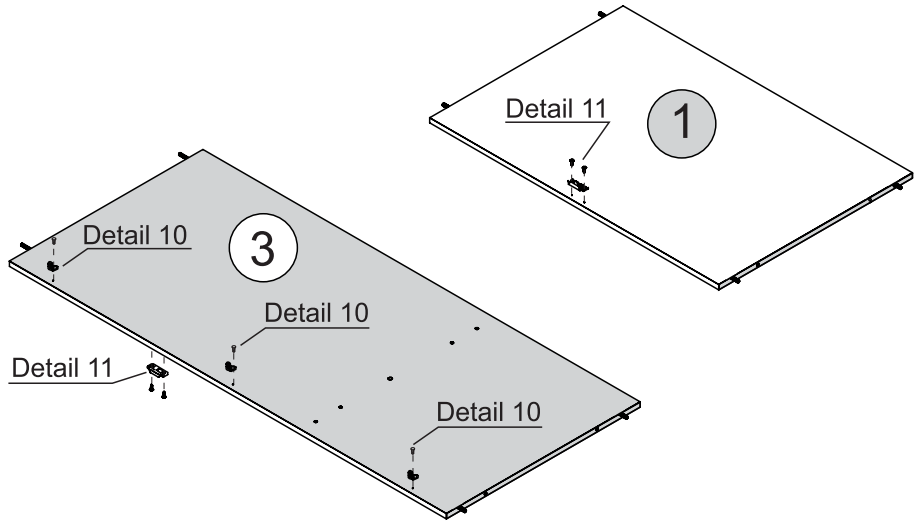
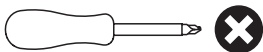

STEP 10

PARTS REQUIRED

1 - LARGE BASE PANEL x1

2 - DIVISION PANEL x1

3 - TOP PANEL x1

5 - SMALL BASE PANEL x1

HARDWARE REQUIRED

E  06
Ø4,0 x 45mm

V  01

TOOLS REQUIRED

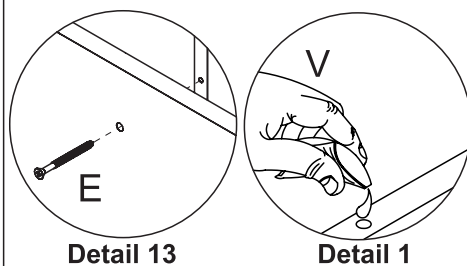
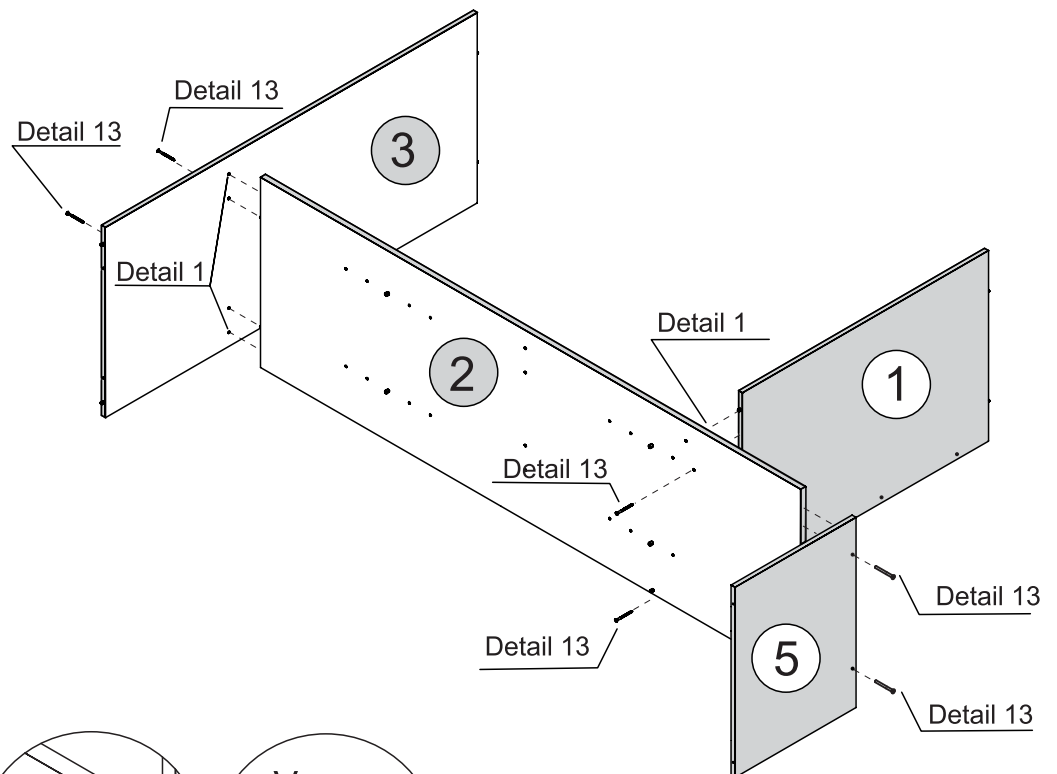
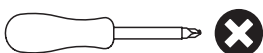



STEP 11

PARTS REQUIRED

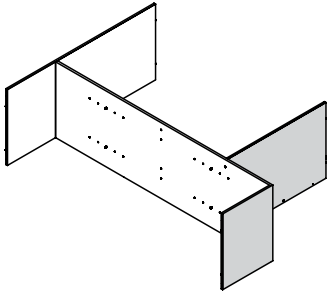
4 - LEFT SIDE PANEL x1



HARDWARE REQUIRED

- E  Ø4,0 x 45mm 04
- V  01

TOOLS REQUIRED

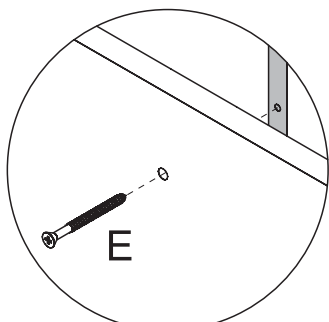
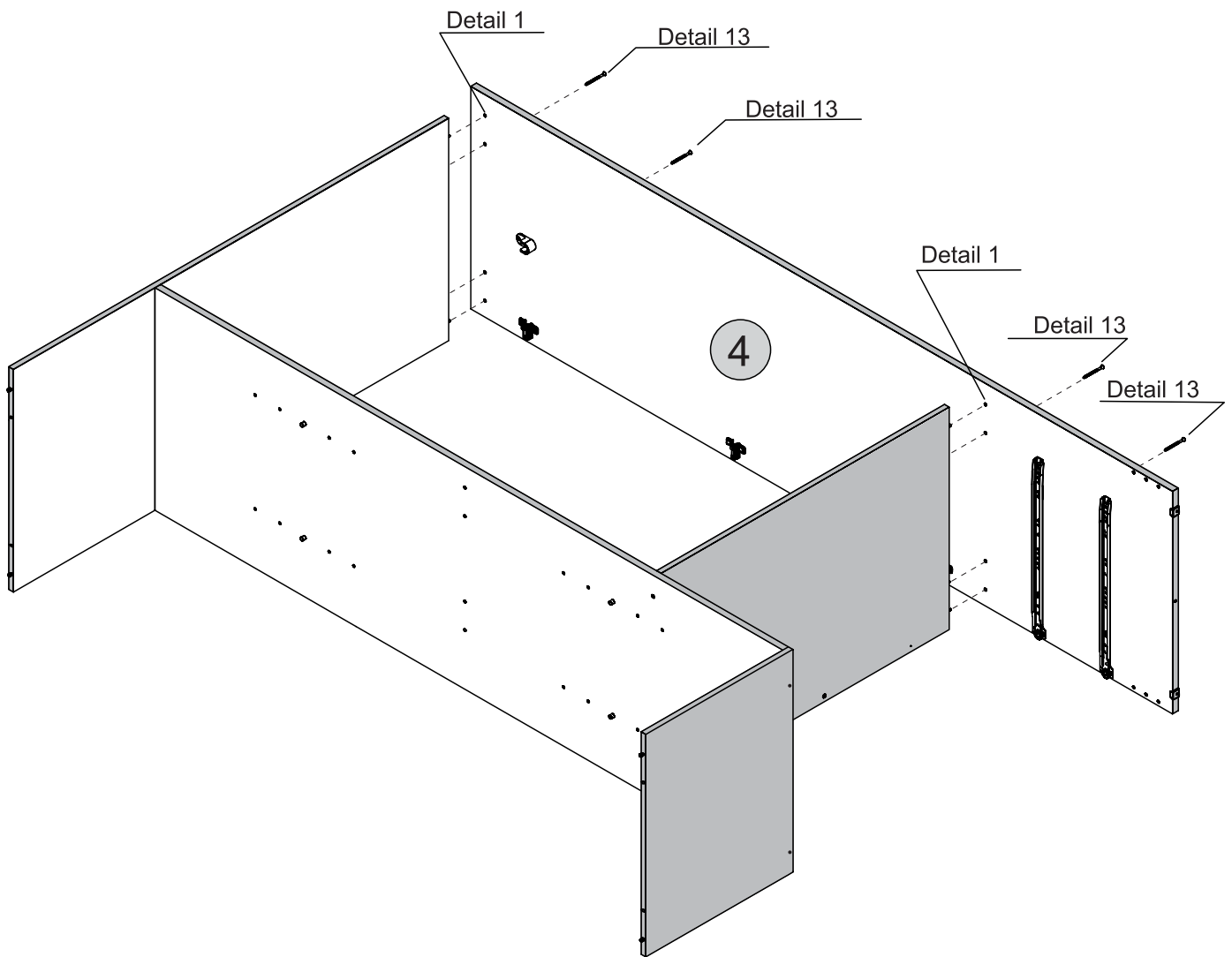
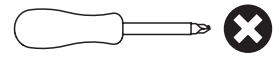

Detail 13

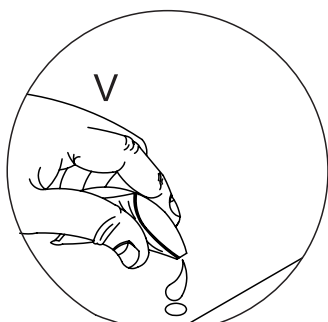

Detail 1



STEP 12

PARTS REQUIRED

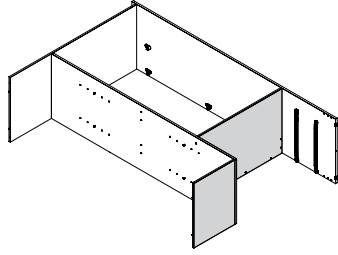
6 - RIGHT SIDE PANEL	x1
7 - FRONT BASEBOARD	x1
8 - BACK BASEBOARD	x1
20 - SHELF	x1



HARDWARE REQUIRED

E	 Ø4,0 x 45 mm	14
V	 Glue	01

TOOLS REQUIRED

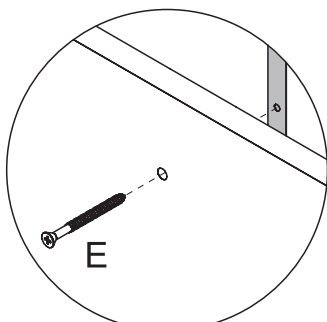
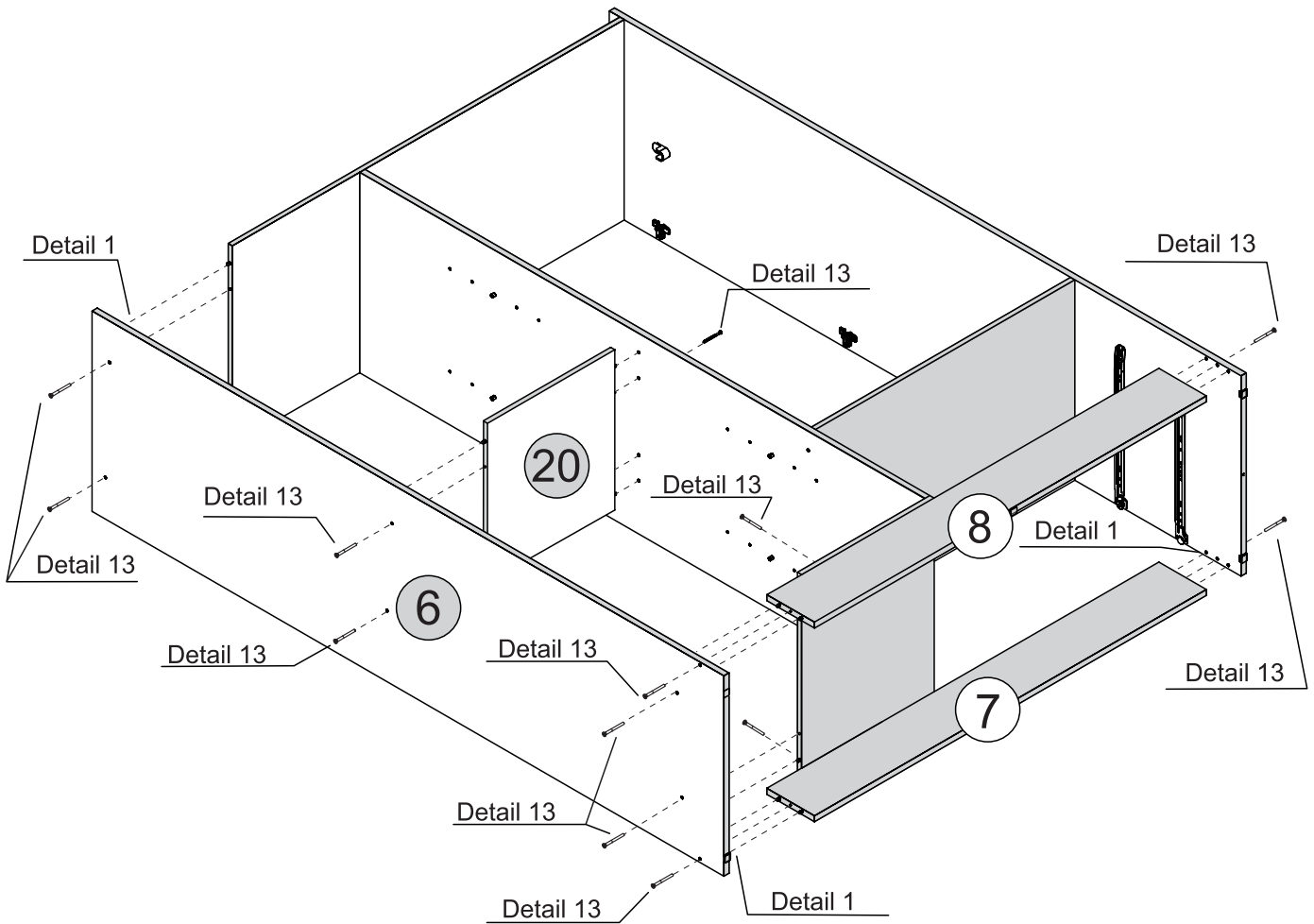
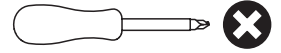

Detail 13

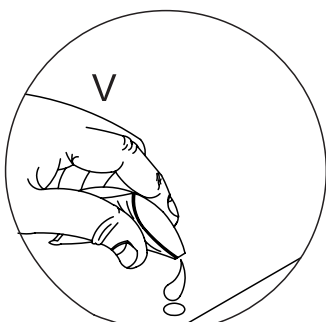

Detail 1



STEP 13

PARTS REQUIRED

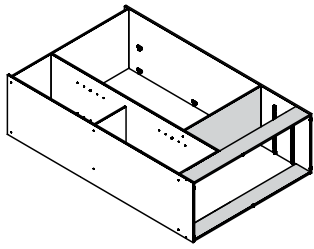
- 9 - SMALL BACK PANEL x2
- 21 - LARGE BACK PANEL x1

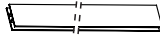

HARDWARE REQUIRED

- H  62
- I  14
- R  01

TOOLS REQUIRED

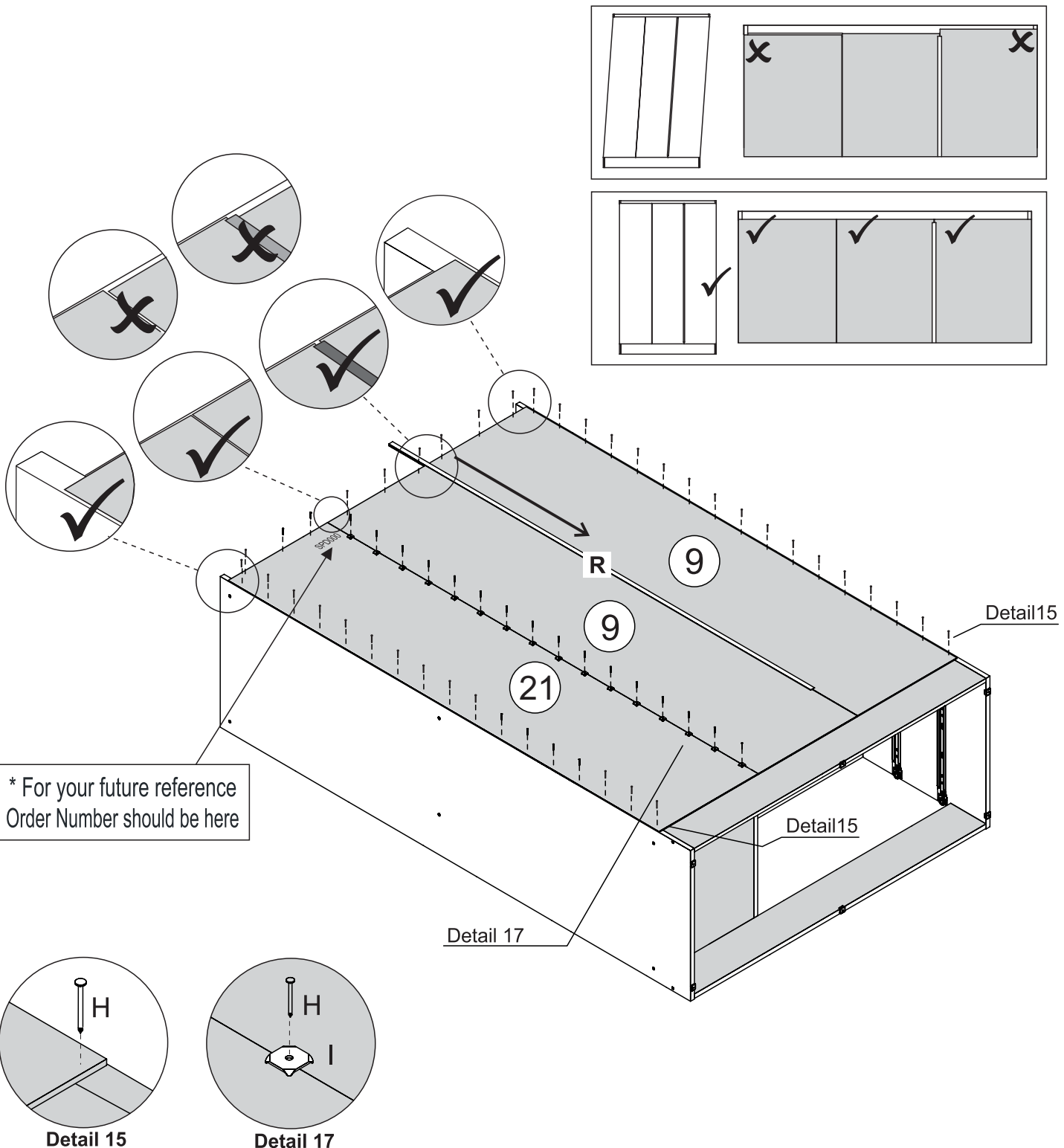
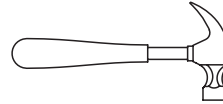

* For your future reference
Order Number should be here

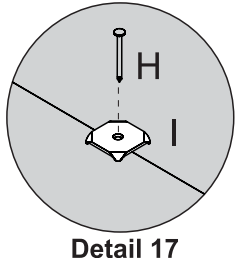
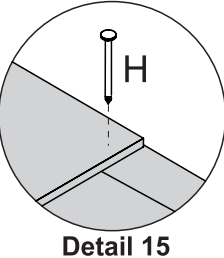

STEP 14

PARTS REQUIRED

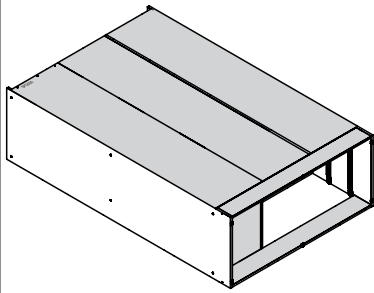

HARDWARE REQUIRED

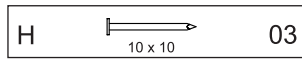

TOOLS REQUIRED

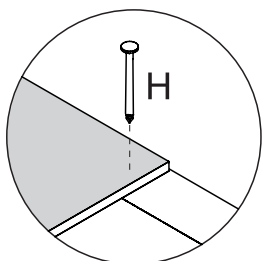
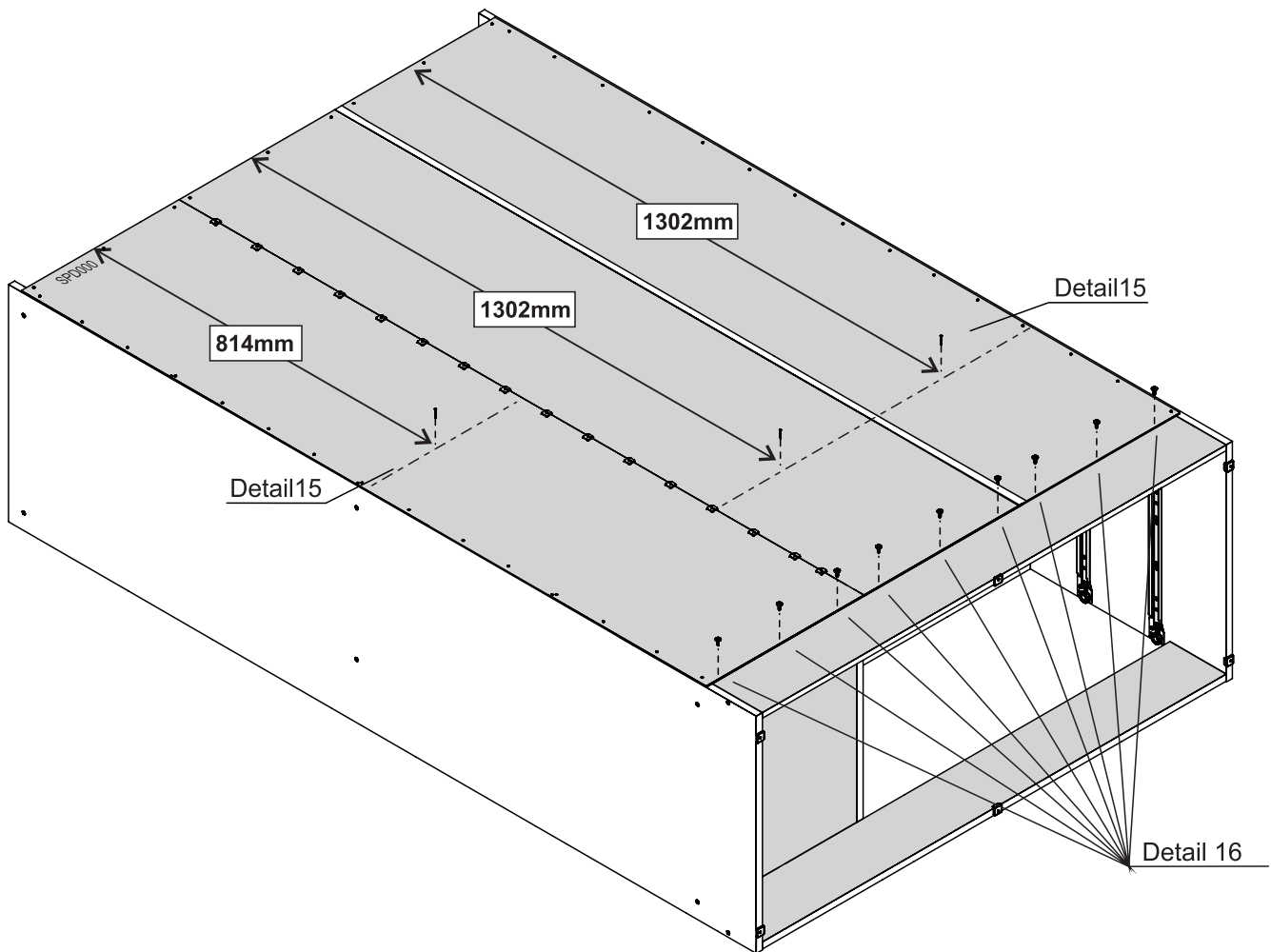
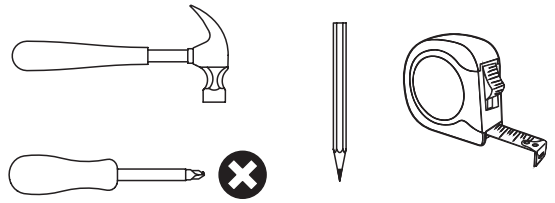

Detail 15

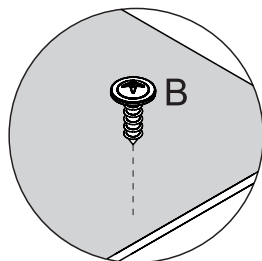

Detail 16

STEP 15

PARTS REQUIRED

10 - FRAME x1

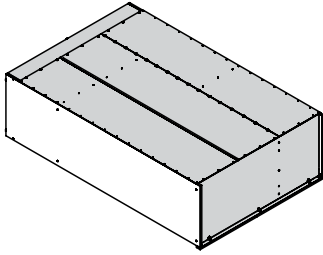

HARDWARE REQUIRED

J 02

F Ø4,0 x 12mm 07

TOOLS REQUIRED

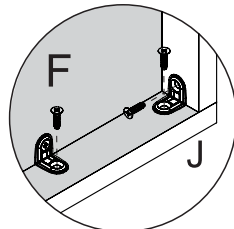
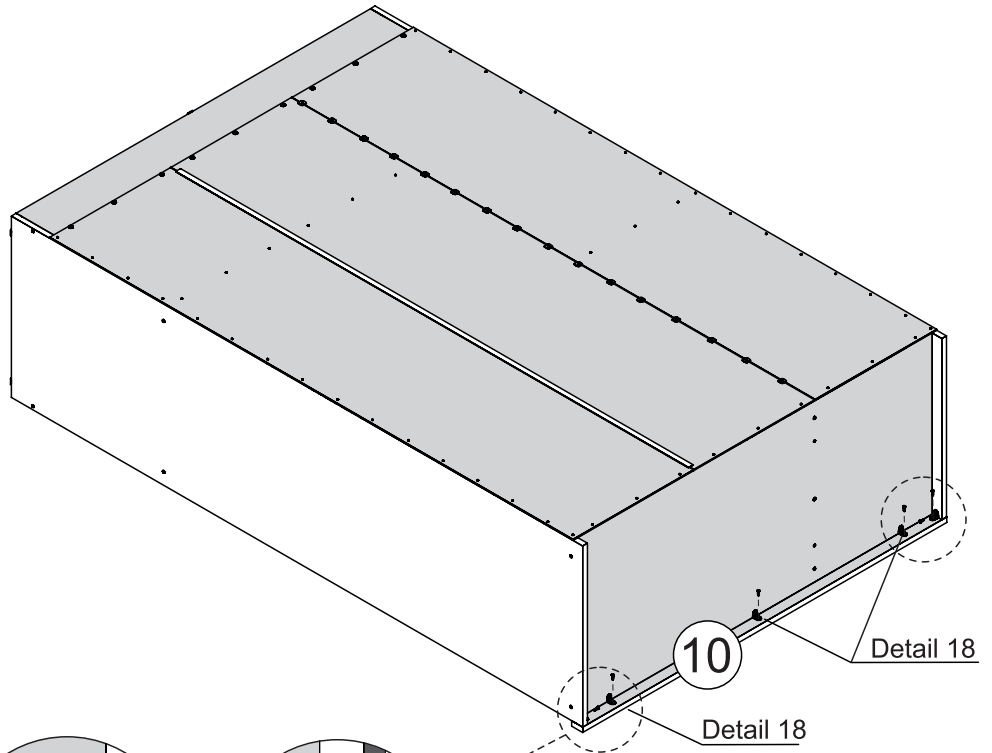
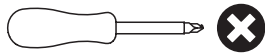

Detail 18

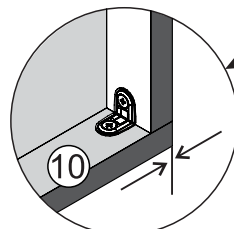

Align corners

STEP 16

PARTS REQUIRED

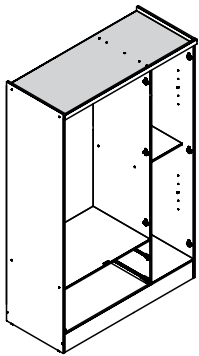

HARDWARE REQUIRED

N 01

TOOLS REQUIRED

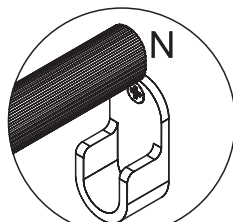
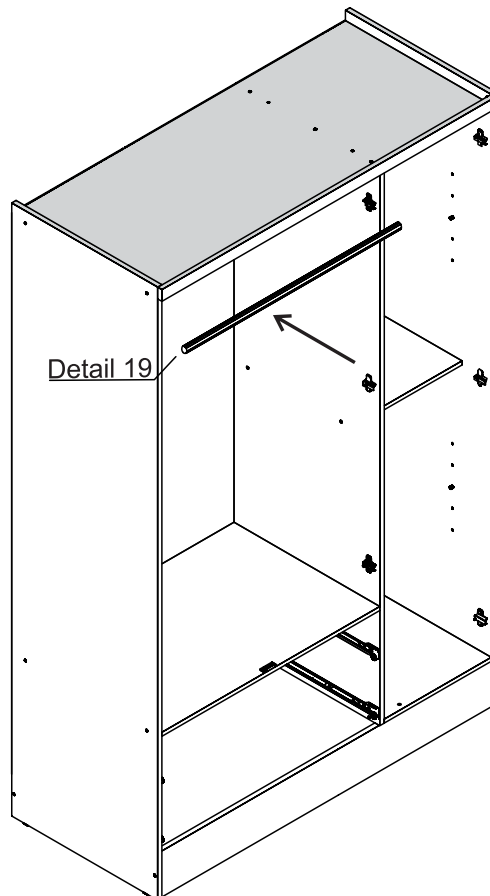



Detail 19

STEP 17

PARTS REQUIRED

- 15 - DRAWER SIDE x4
- 16 - DRAWER BACK PANEL x2
- 17 - DRAWER FRONT x2
- 19 - DRAWER BOTTOM SUPPORT BAR x2

HARDWARE REQUIRED

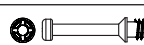
- G  20
Ø6,0 x 30mm
- V  01
- X  04

TOOLS REQUIRED

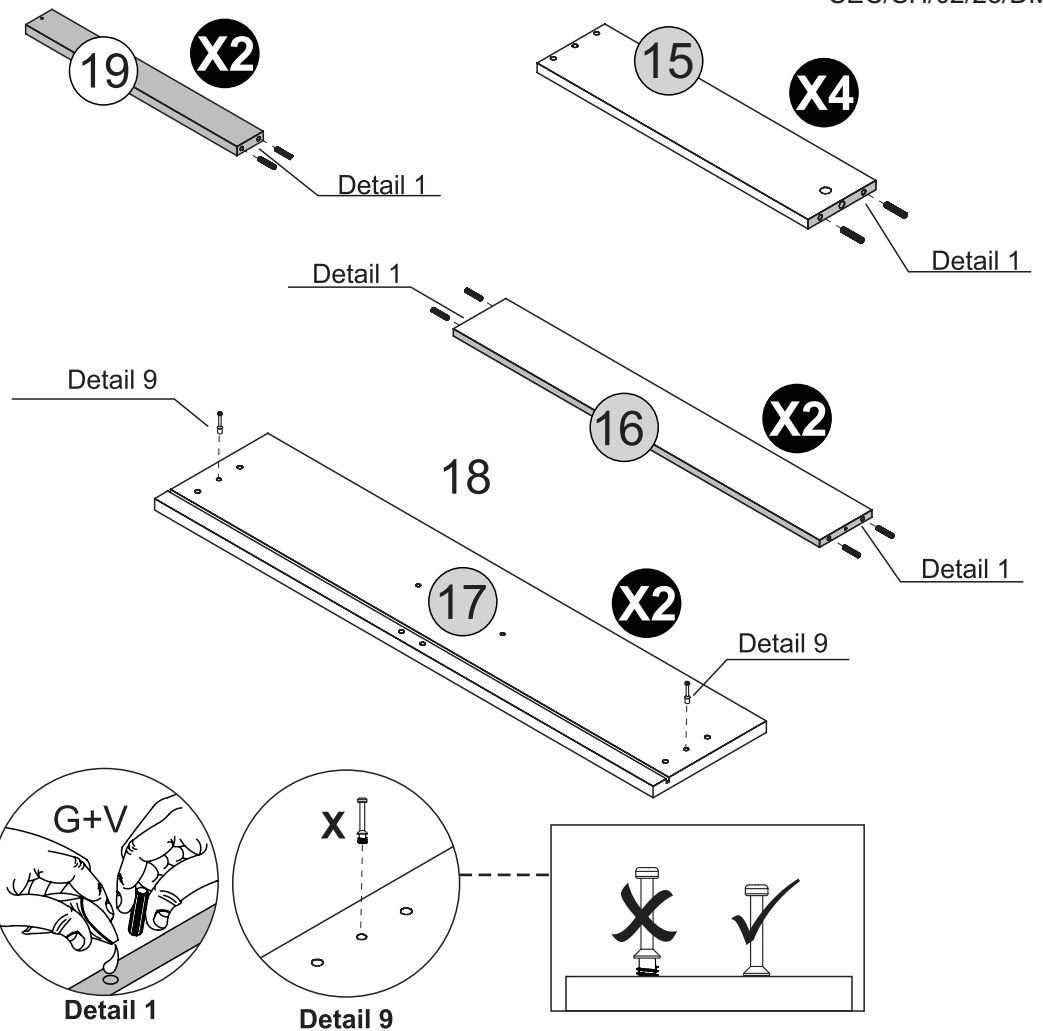
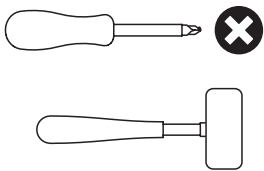

STEP 18

PARTS REQUIRED

- 15 - DRAWER SIDE x4
- 16 - DRAWER BACK PANEL x2

HARDWARE REQUIRED

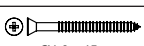
- E  04
Ø4,0 x 45mm

TOOLS REQUIRED

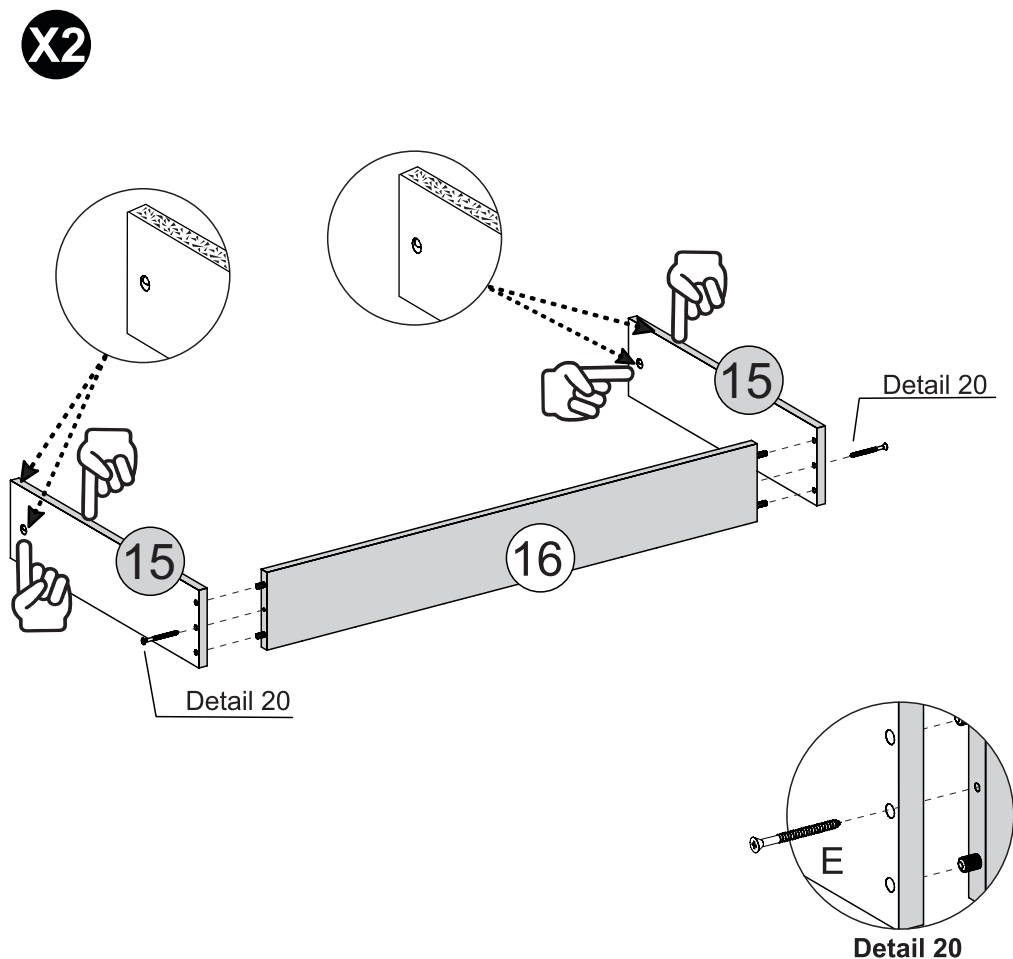
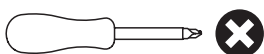

STEP 19

PARTS REQUIRED

17 - DRAWER FRONT x2

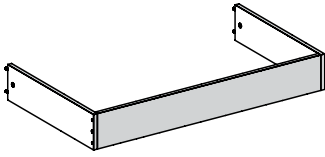

HARDWARE REQUIRED

V  01

TOOLS REQUIRED

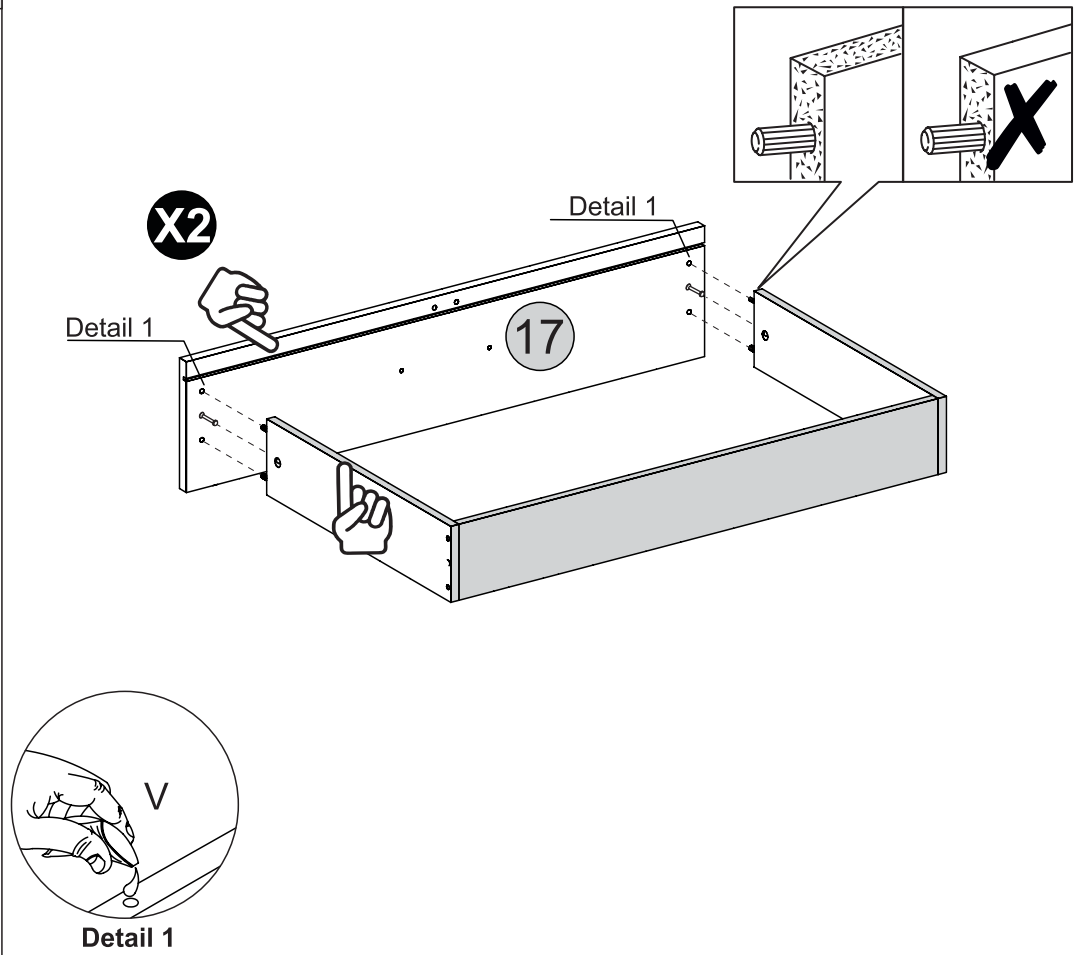

STEP 20

PARTS REQUIRED

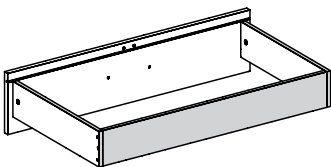

HARDWARE REQUIRED

U  08

W  04

TOOLS REQUIRED

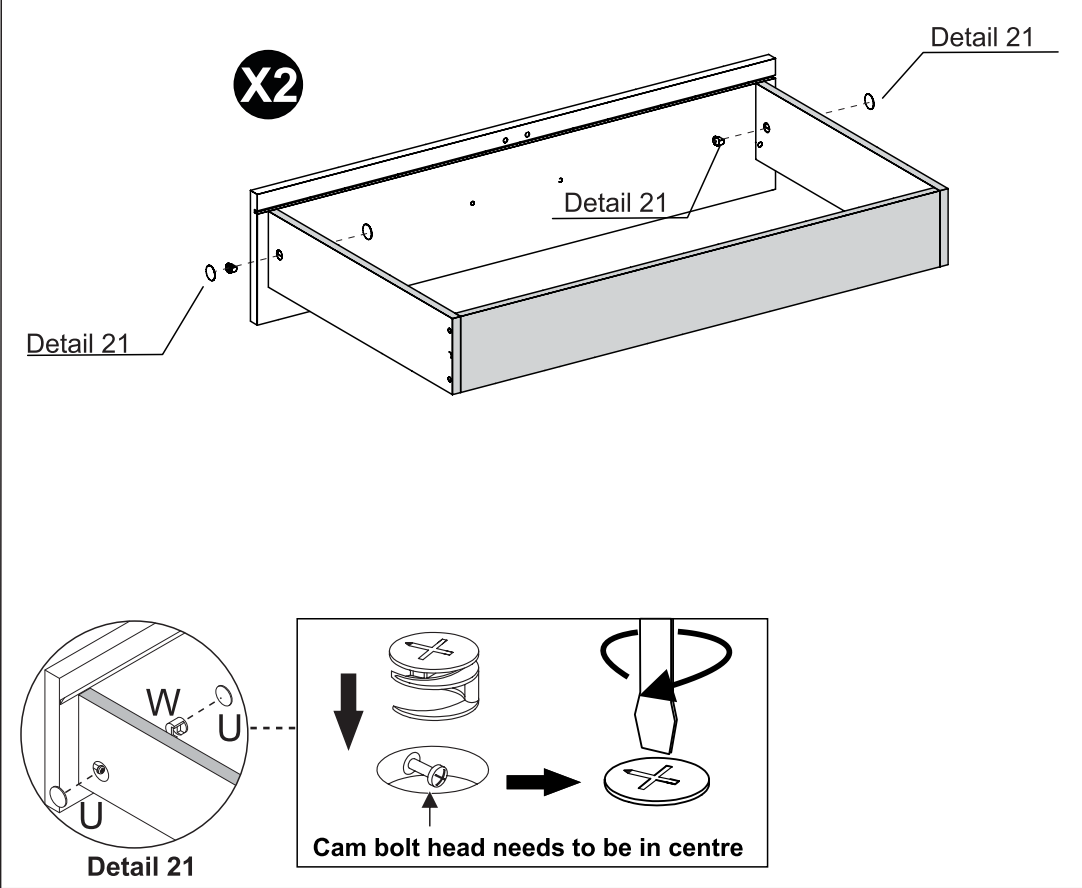
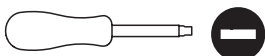

STEP 21

PARTS REQUIRED

18 - DRAWER BOTTOM x2

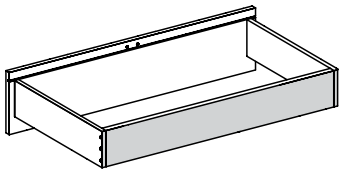

HARDWARE REQUIRED

H  08
10 x 10

TOOLS REQUIRED

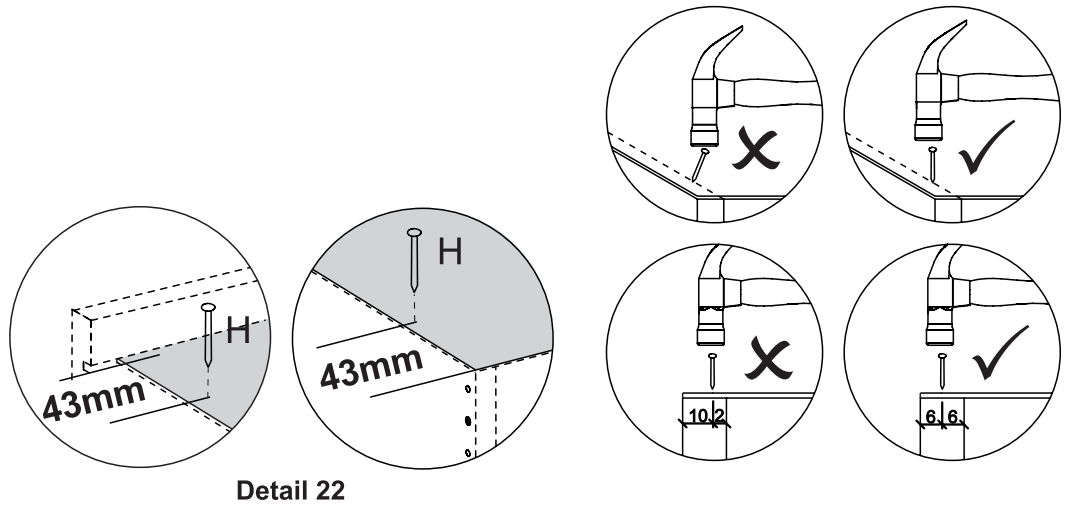
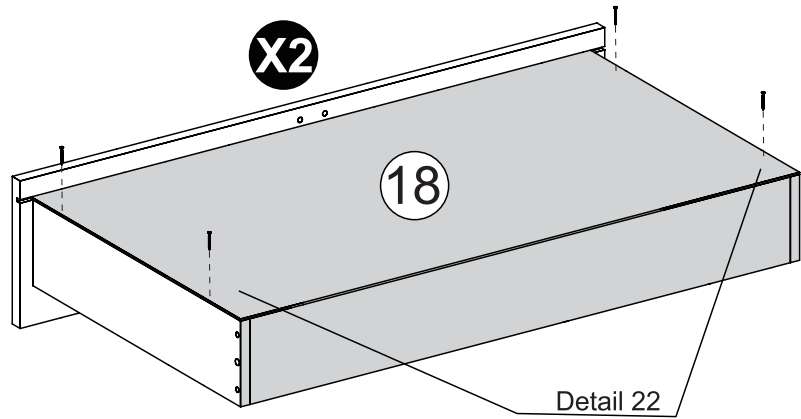
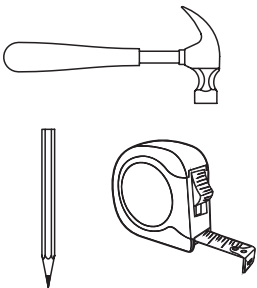

STEP 22

PARTS REQUIRED

19 - DRAWER BOTTOM SUPPORT BAR x2

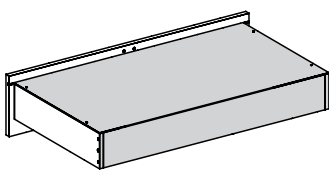

HARDWARE REQUIRED

H  12
10 x 10

V  01
Glue

TOOLS REQUIRED

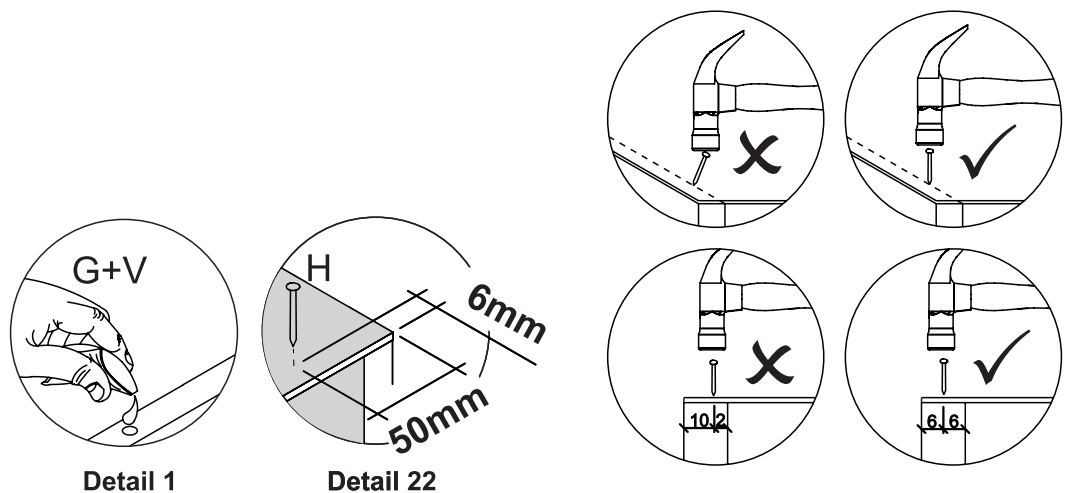
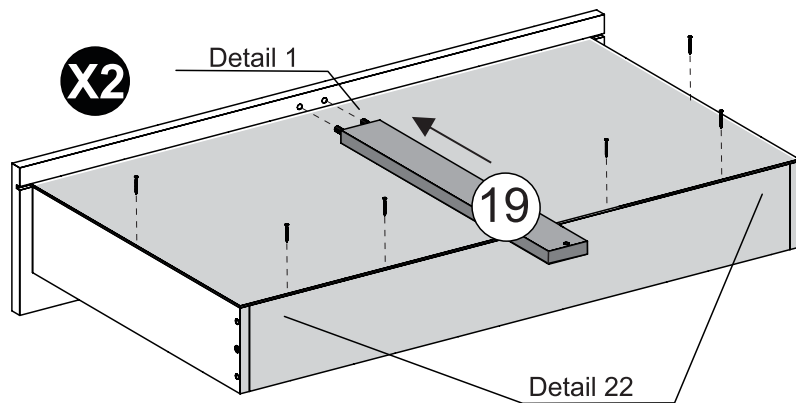
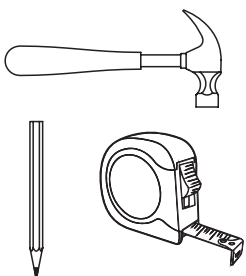

STEP 23

PARTS REQUIRED

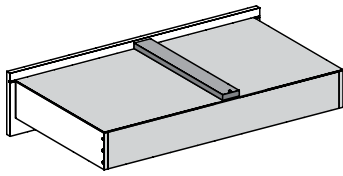

HARDWARE REQUIRED

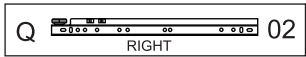
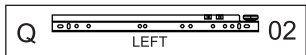
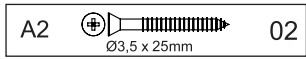
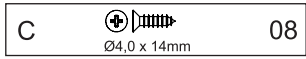

TOOLS REQUIRED

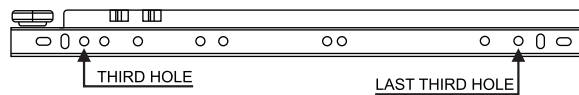
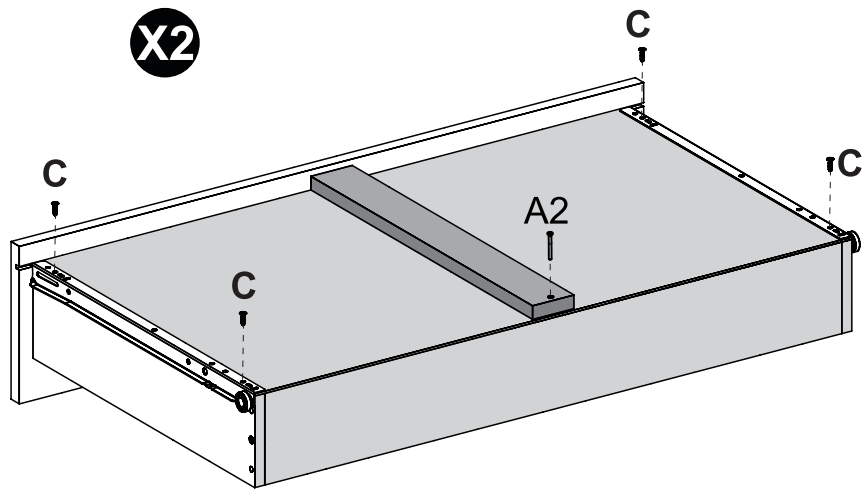
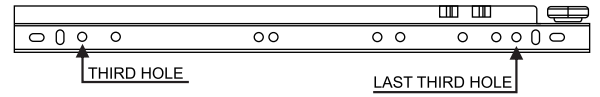

STEP 24

PARTS REQUIRED



HARDWARE REQUIRED

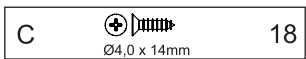

TOOLS REQUIRED

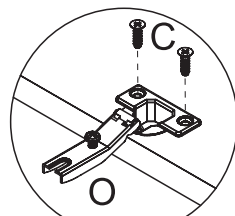
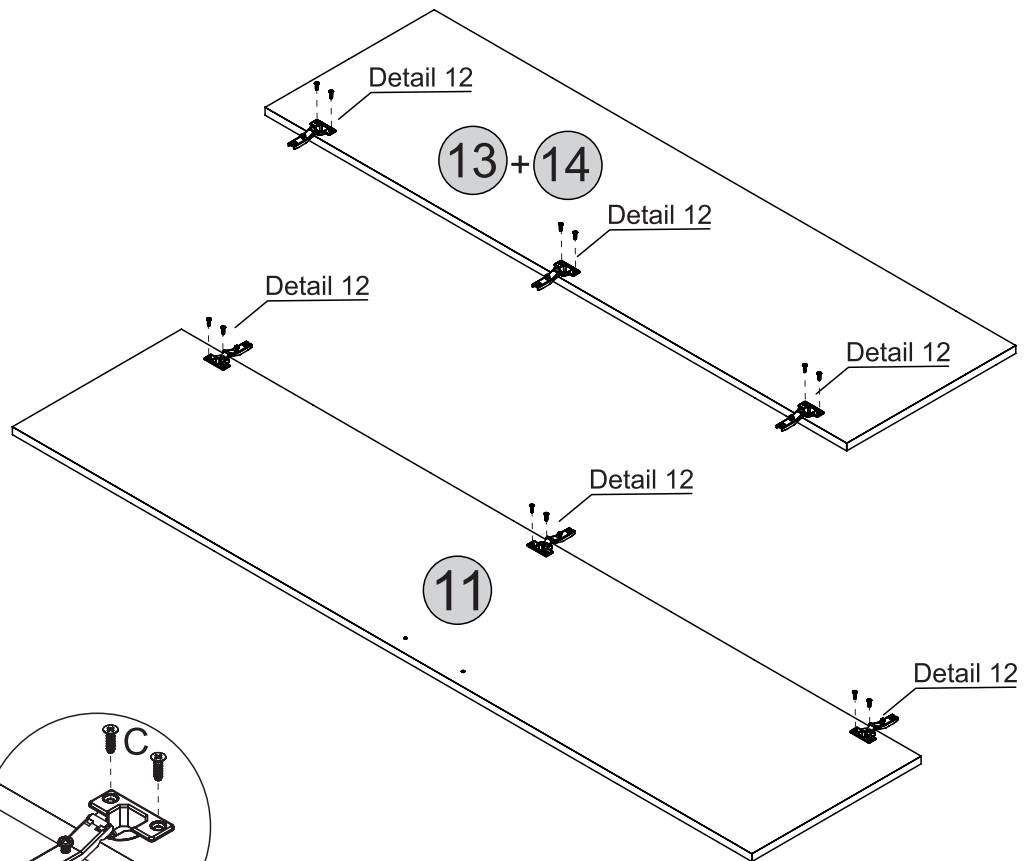
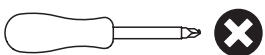

Detail 12

STEP 25

PARTS REQUIRED

11 - LARGE DOOR x1

13 - RIGHT SMALL DOOR x1

14 - LEFT SMALL DOOR x1

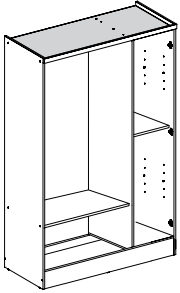

HARDWARE REQUIRED

U  12

TOOLS REQUIRED

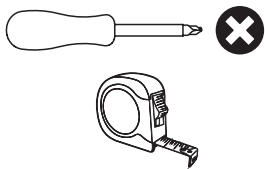

!
Please note the top or bottom edges of the doors are labelled LEFT or RIGHT to make them easier to identify when assembling.

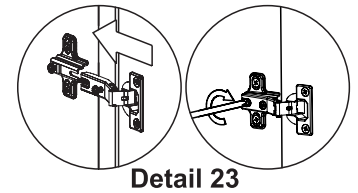
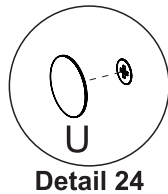
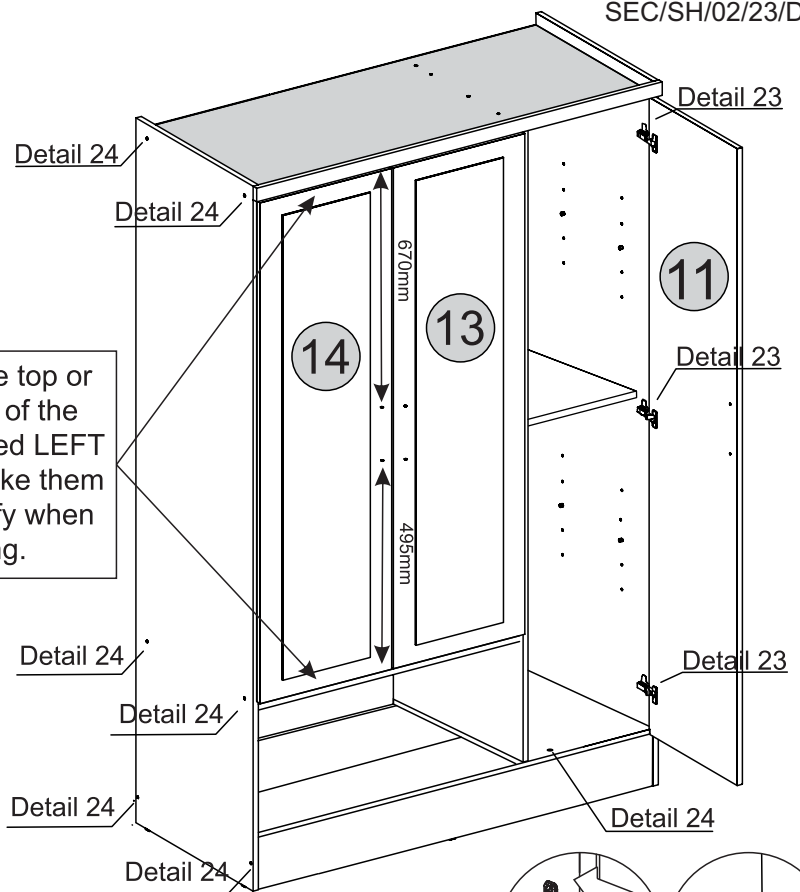

STEP 26

PARTS REQUIRED

12 - MOVEABLE SHELF x2

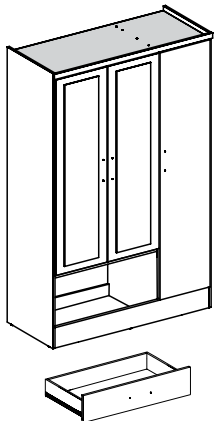

HARDWARE REQUIRED

D  10
Ø4,0 x 20mm

T  05

TOOLS REQUIRED

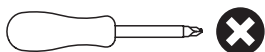

TIP
If desired, after assembly use an alcohol cleaner to erase the number printed on the parts.

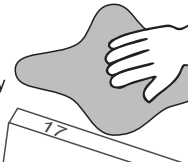

!
See the last page

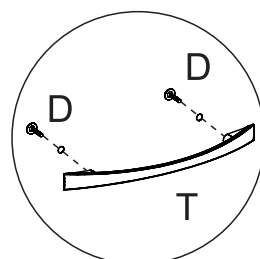
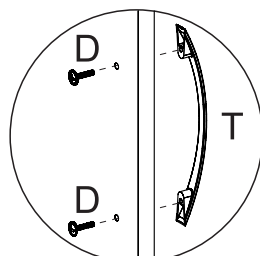
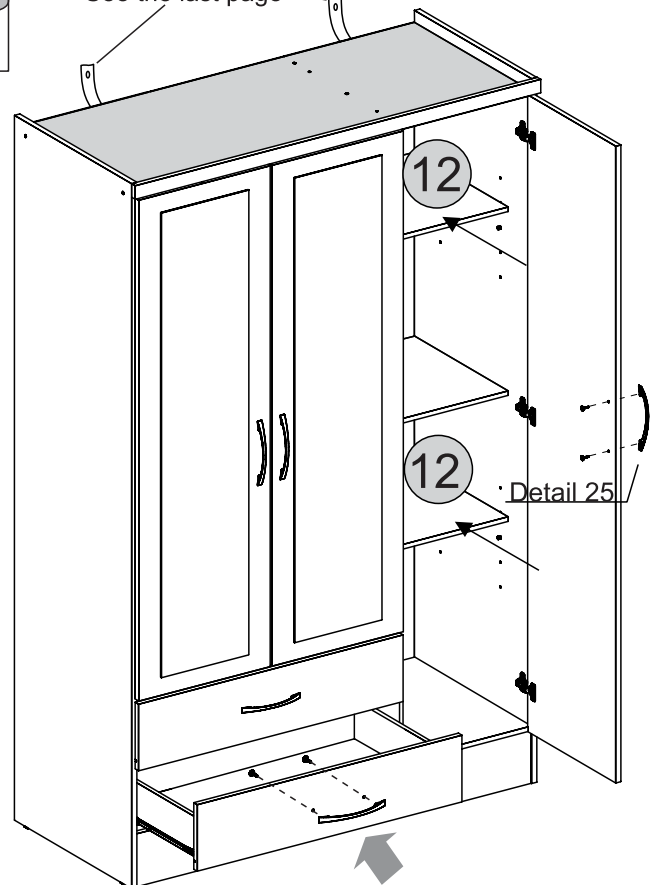

Detail 25

STEP 25

PARTS REQUIRED

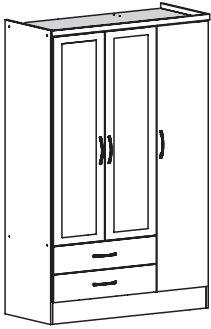

HARDWARE REQUIRED

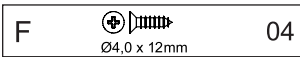

TOOLS REQUIRED

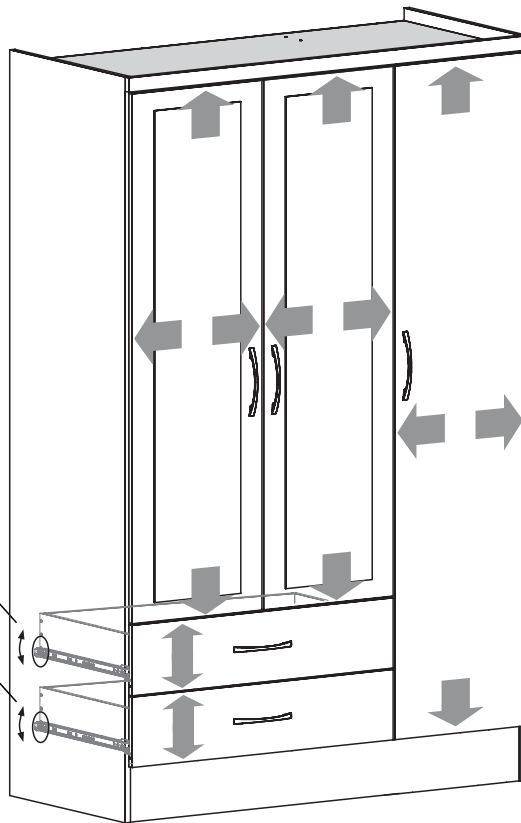

Detail 26

Detail 26

Drawer Adjustment

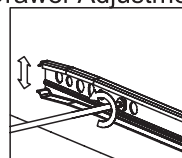

Drawer Lock

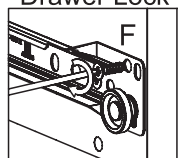

Detail 26

Height Adjustment

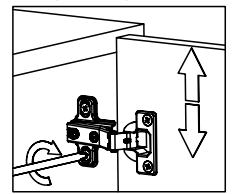

Internal Adjustment

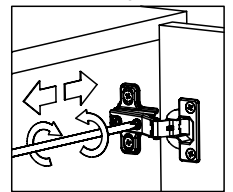

Depth Adjustment

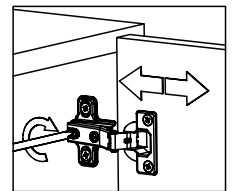
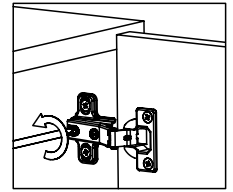

WARNING

Serious or fatal injuries can occur from furniture tipping over. To prevent the furniture from tipping over we recommend that it is permanently fixed to the wall.

Wall fixings are not supplied with this product as different wall materials require different types of fixing devices.

Please make sure you use fixings suitable for the walls in your home.

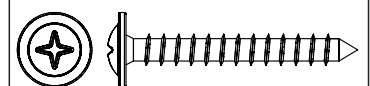
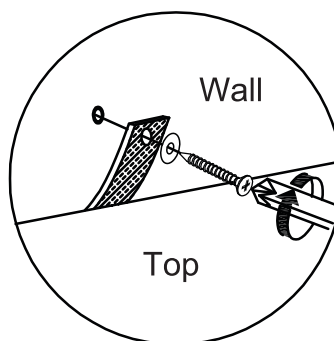
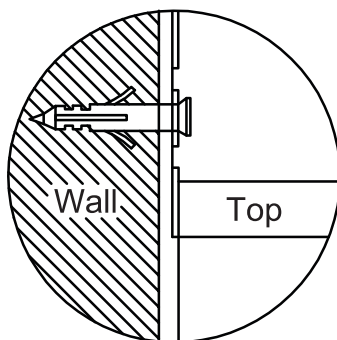
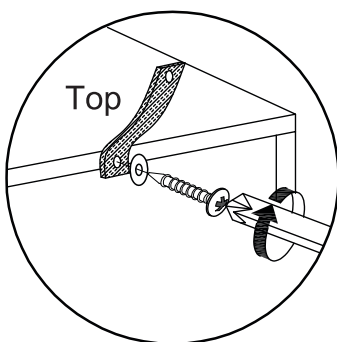

Y Flan Head Screw
Ø3,5 x 30mm (2x)



K Washer (4x)



S Strap (2x)

NEVADA 3+2 DRAWER CHEST ASSEMBLY INSTRUCTIONS

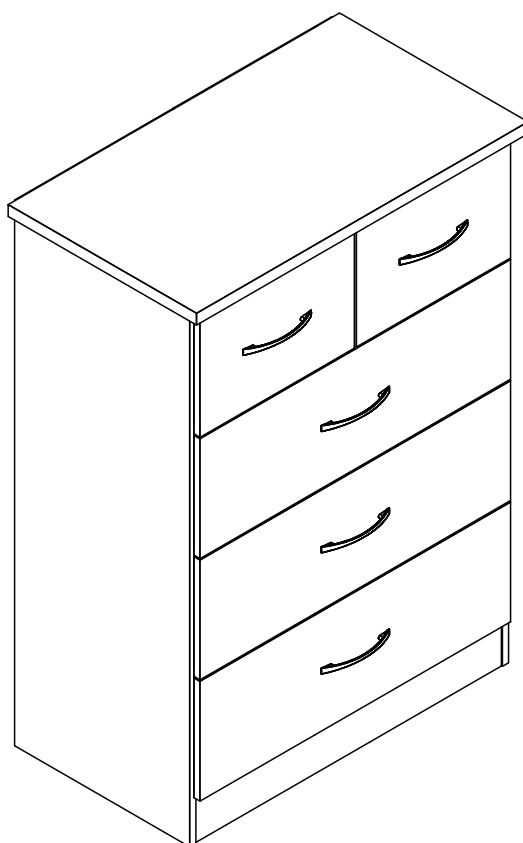

IMPORTANT FOR DOMESTIC USE ONLY

PLEASE READ BEFORE YOU CONTINUE FURTHER

CARE AND MAINTENANCE

After unpacking this product please keep the original packaging in case it needs to be returned for any reason.

- Please ensure all fittings and parts are present before commencing with assembly.
- Never drag or push products as this could cause damage to the joints making it inferior.
- We strongly recommend that you keep children away from your work area.
- We recommend that you lay a blanket or sheet on the floor to avoid damage to both your floor and the product.
- Assemble this product as close to its final position as possible.
- Do not place this product next to a radiator or in direct sunlight.
- Do not drag or push items across your high gloss furniture as this may cause the surface to scratch
- Wood is a natural product and may expand if subjected to damp and may shrink or crack if subjected to heat. Therefore it is recommended that room temperature is maintained, with no sudden temperature fluctuations.
- Make sure any spillage is wiped off immediately.
- Do not place hot or chilled items directly on to the surface, use a place mat or marking will occur.
- For general cleaning use a soft cotton or micro fibre cloth, and do not use detergents of any kind.
- From time to time it may be necessary to tighten fittings, regular inspections should be carried out.
- Do not place on a wet or damp floor as staining may occur to your floor.

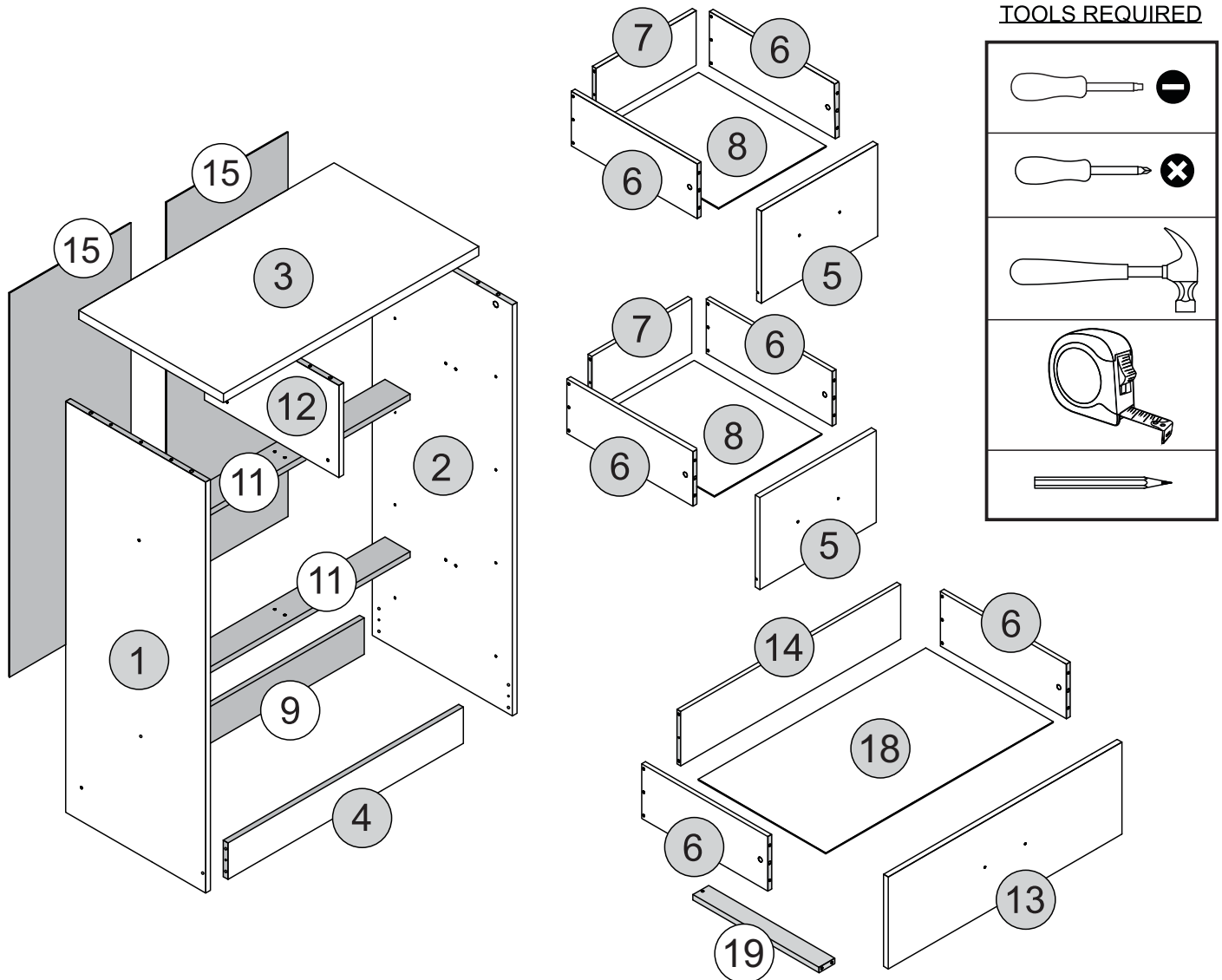









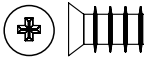
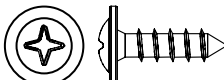
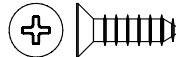
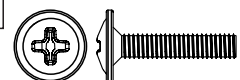

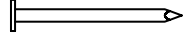

PARTS LIST

Please Note:
The below parts have all been stamped with the part number to help identify them during assembly.

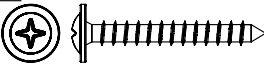
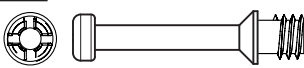
Part Number	Part Description	Quantity	Carton
1	Left Side Panel	1	1/2
2	Right Side Panel	1	1/2
3	Top Panel	1	2/2
4	Front Baseboard	1	1/2
5	Small Drawer Front	2	2/2
6	Drawer Side	10	1/2
7	Small Drawer Back Panel	2	1/2
8	Small Drawer Bottom	2	1/2
9	Back Baseboard	1	1/2
11	Crossbar	2	2/2
12	Division Panel	1	1/2
13	Large Drawer Front	3	2/2
14	Large Drawer Back Panel	3	1/2
15	Back Panel	2	1/2
18	Large Drawer Bottom	3	2/2
19	Drawer Bottom Support Bar	3	1/2

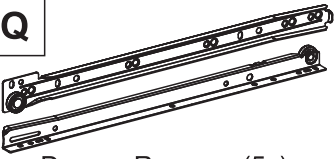
FITTINGS LIST

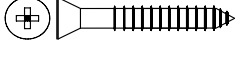
<p>A</p>  <p>Flat Head Screw Ø6,0 x 8mm (20x) 2/+</p>	<p>B</p>  <p>Flan Head Screw Ø3,5 x 12mm (6x) 1/+</p>	<p>C</p>  <p>Flat Head Screw Ø4,0 x 14mm (30x) 2/+</p>	<p>D</p>  <p>Flan Head Screw Ø4,0 x 20mm (10x) 2/+</p>
<p>E</p>  <p>Flat Head Screw Ø4,0 x 45mm (19x) 2/+</p>	<p>F</p>  <p>Handle (5x)</p>	<p>G</p>  <p>2/+ Dowel Ø6,0 x 30mm (65x)</p>	<p>H</p>  <p>3/+ Nail 10 x 10 (87x)</p>
<p>I</p>  <p>1/+ Back Panel Bracket (2x)</p>	<p>J</p>  <p>2/+ Cam Nut Ø12mm (16x)</p>	<p>K</p>  <p>1/+ Washer (4x)</p>	<p>L</p>  <p>1/+ Plastic Foot (6x)</p>
<p>M</p>  <p>Flan Head Screw Ø3,5 x 30mm (2x) 1/+</p>	<p>N</p>  <p>2/+ Cam Bolt (16x)</p>	<p>O</p>  <p>2/+ Hole Plugs (28x)</p>	<p>P</p>  <p>Glue (3x)</p>
<p>Q</p>  <p>Drawer Runners (5x)</p>	<p>R</p>  <p>Back Panel Strip (1x)</p>	<p>S</p>  <p>Strap (2x)</p>	<p>T</p>  <p>Flat Head Screw Ø3,5 x 25mm (3x) 1/+</p>

TIPS FOR FITTINGS CAM-LOCKS

WHEN FITTING CAM NUT. ENSURE STARTING POSITION IS CORRECT BEFORE YOU INSERT CONNECTING CAM BOLT TURN CLOCKWISE UNTIL SECURE

✓



↑

CORRECT

✗



↑

WRONG

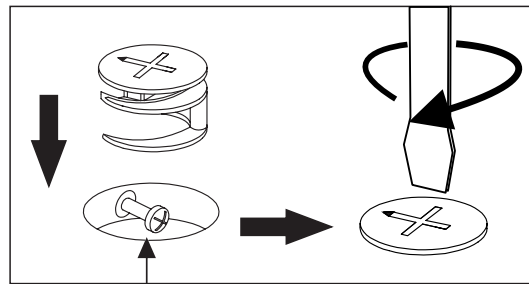

Cam bolt head needs to be in centre

CAMBOLT

Tighten until shoulder in flush with panel. Do not overtighten or undertighten (see example beside)

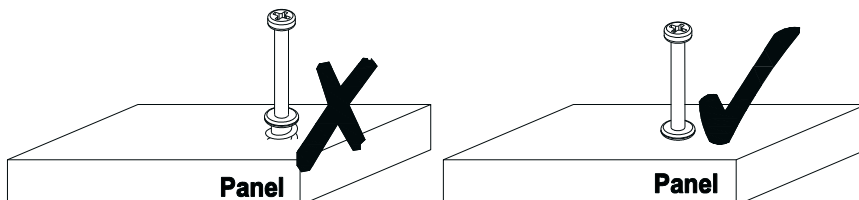
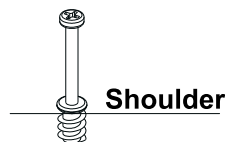



STEP 1

PARTS REQUIRED

1 - LEFT SIDE PANEL x1

HARDWARE REQUIRED

G  02
Ø6 x 30

H  02
10 x 10

L  02

P  01
GLUE

TOOLS REQUIRED

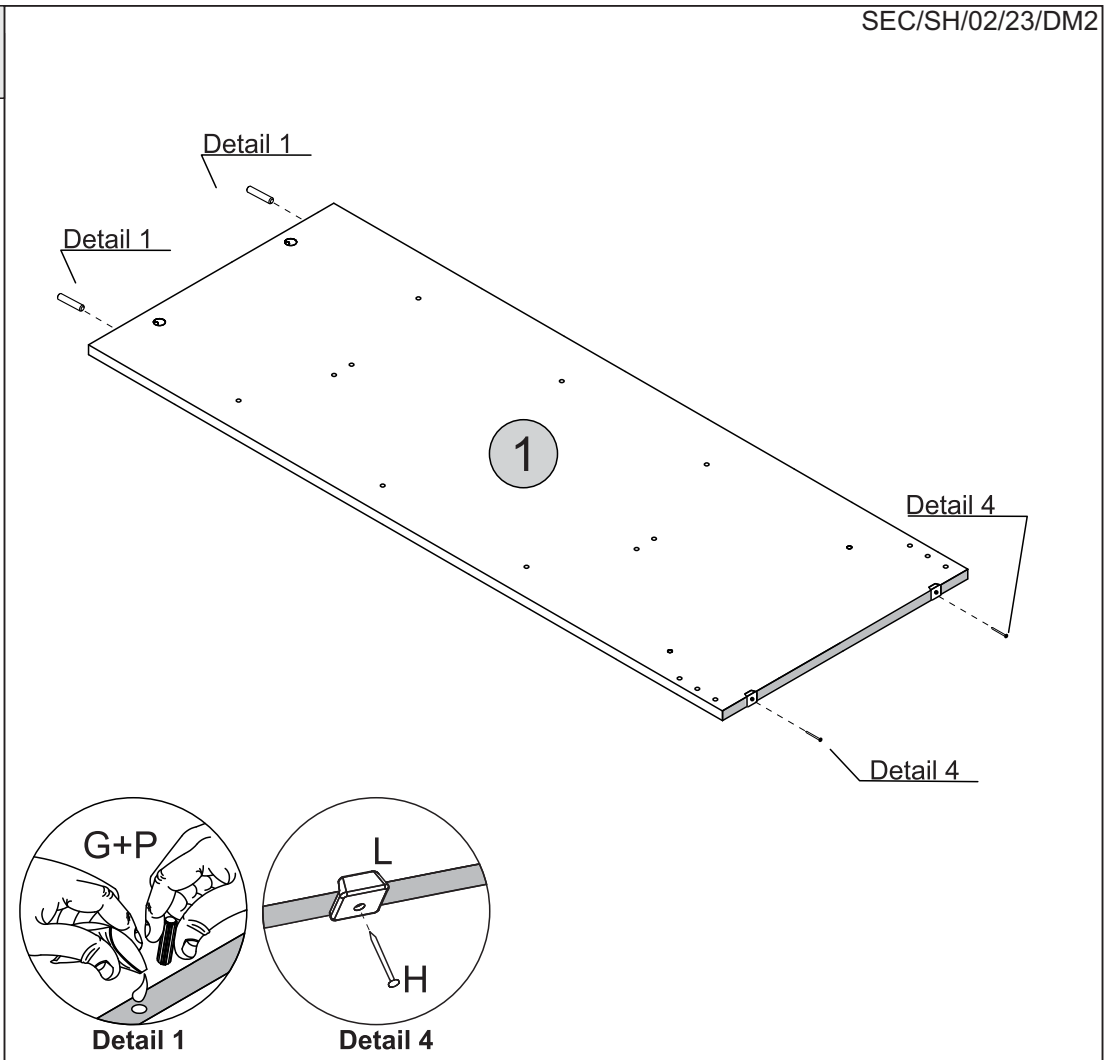
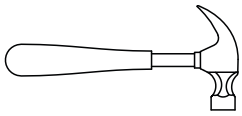



STEP 2

PARTS REQUIRED

2 - RIGHT SIDE PANEL x1

HARDWARE REQUIRED

G  02
Ø6 x 30

H  02
10 x 10

L  02

P  01
GLUE

TOOLS REQUIRED

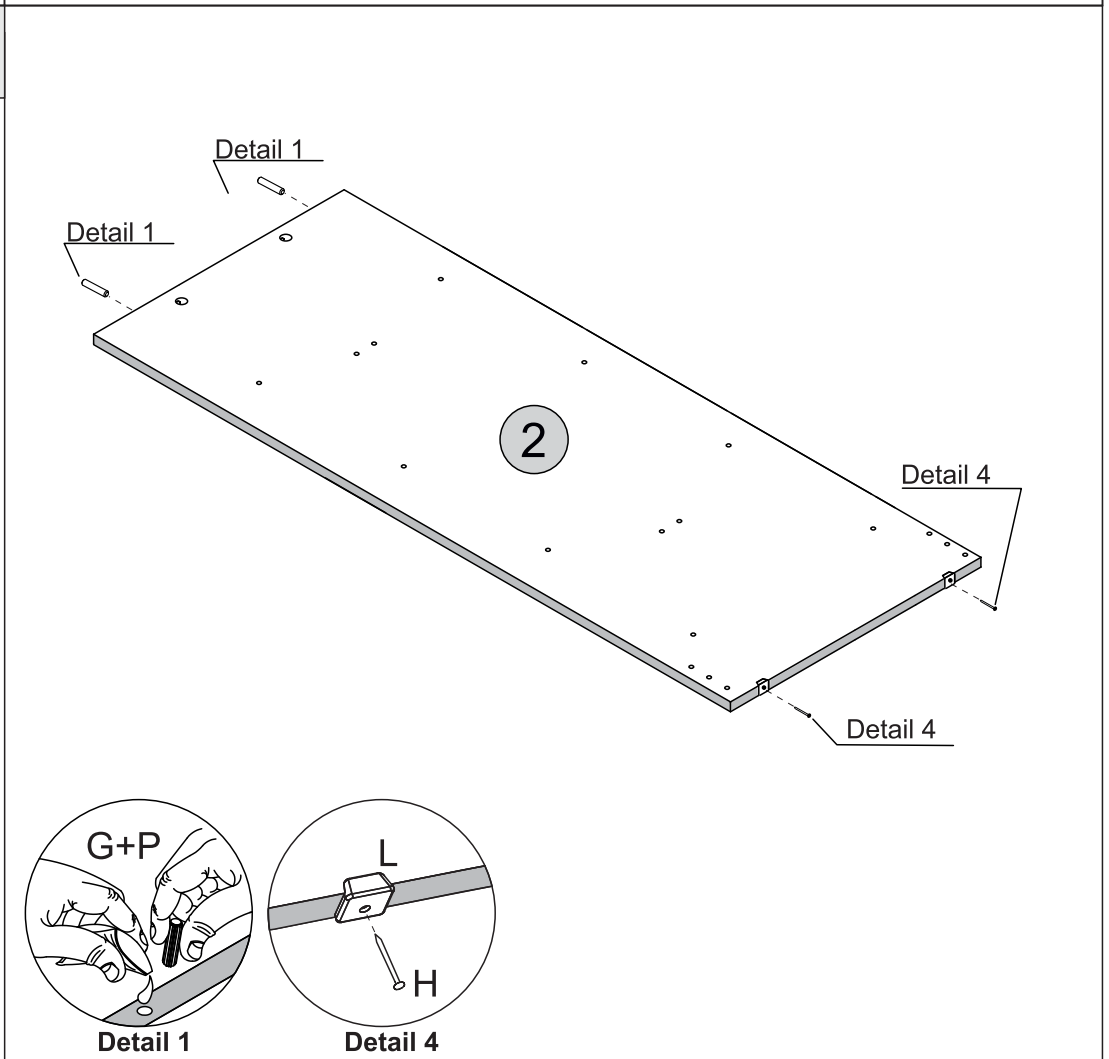
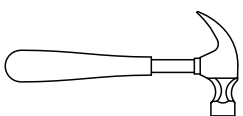

STEP 3

PARTS REQUIRED

1 - LEFT SIDE PANEL x1

HARDWARE REQUIRED

A  08
Ø6,0 x 8mm

Q  04
LEFT

TOOLS REQUIRED

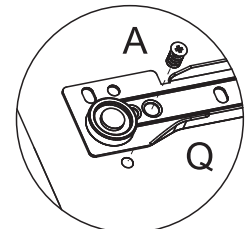
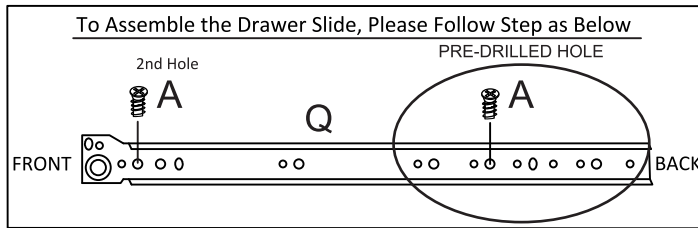
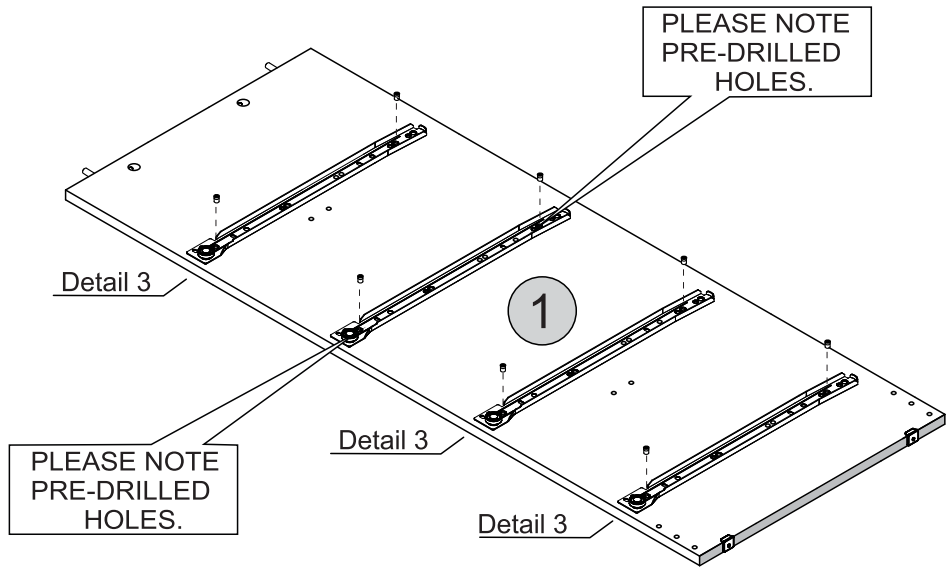
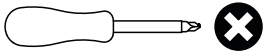

Detail 3

STEP 4

PARTS REQUIRED

2 - RIGHT SIDE PANEL x1

HARDWARE REQUIRED

A  08
Ø6,0 x 8mm

Q  04
RIGHT

TOOLS REQUIRED

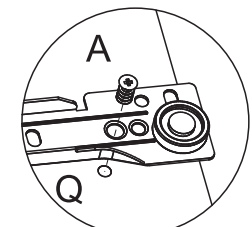
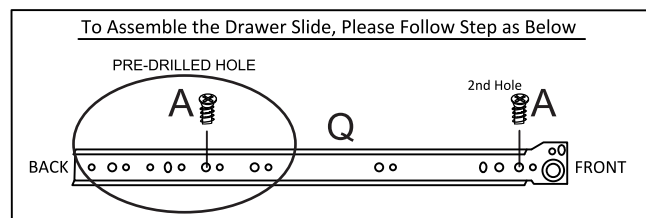
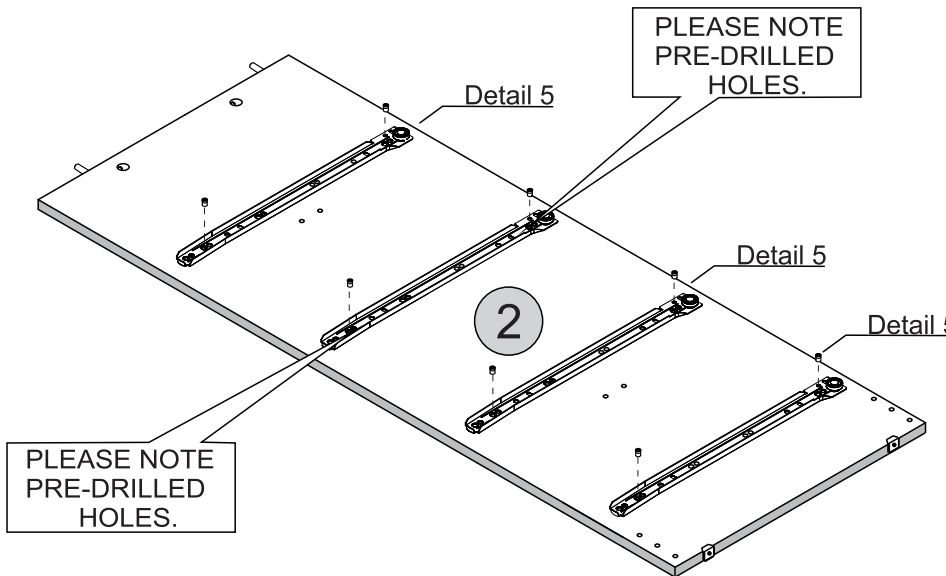
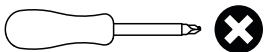



Detail 5

STEP 5

PARTS REQUIRED

4 - FRONT BASEBOARD	x1
9 - BACK BASEBOARD	x1
11 - CROSSBAR	x2

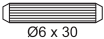
HARDWARE REQUIRED

G		12
H		02
L		02
P	GLUE	01

TOOLS REQUIRED

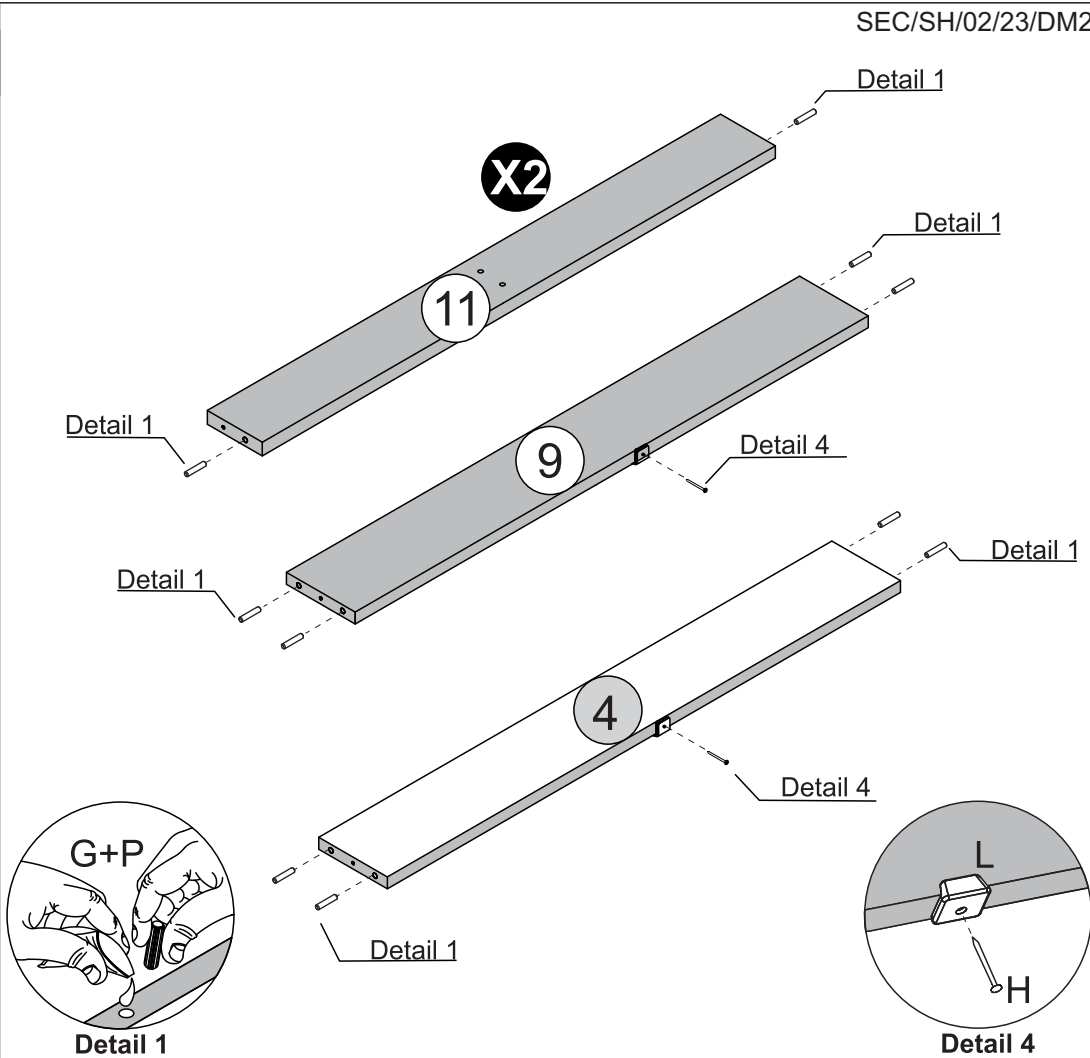
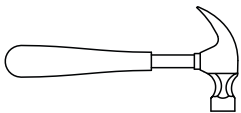



STEP 6

PARTS REQUIRED

12 - DIVISION PANEL	x1
---------------------	----

HARDWARE REQUIRED

A		04
G		03
P	GLUE	01
Q	LEFT	01
Q	RIGHT	01

TOOLS REQUIRED

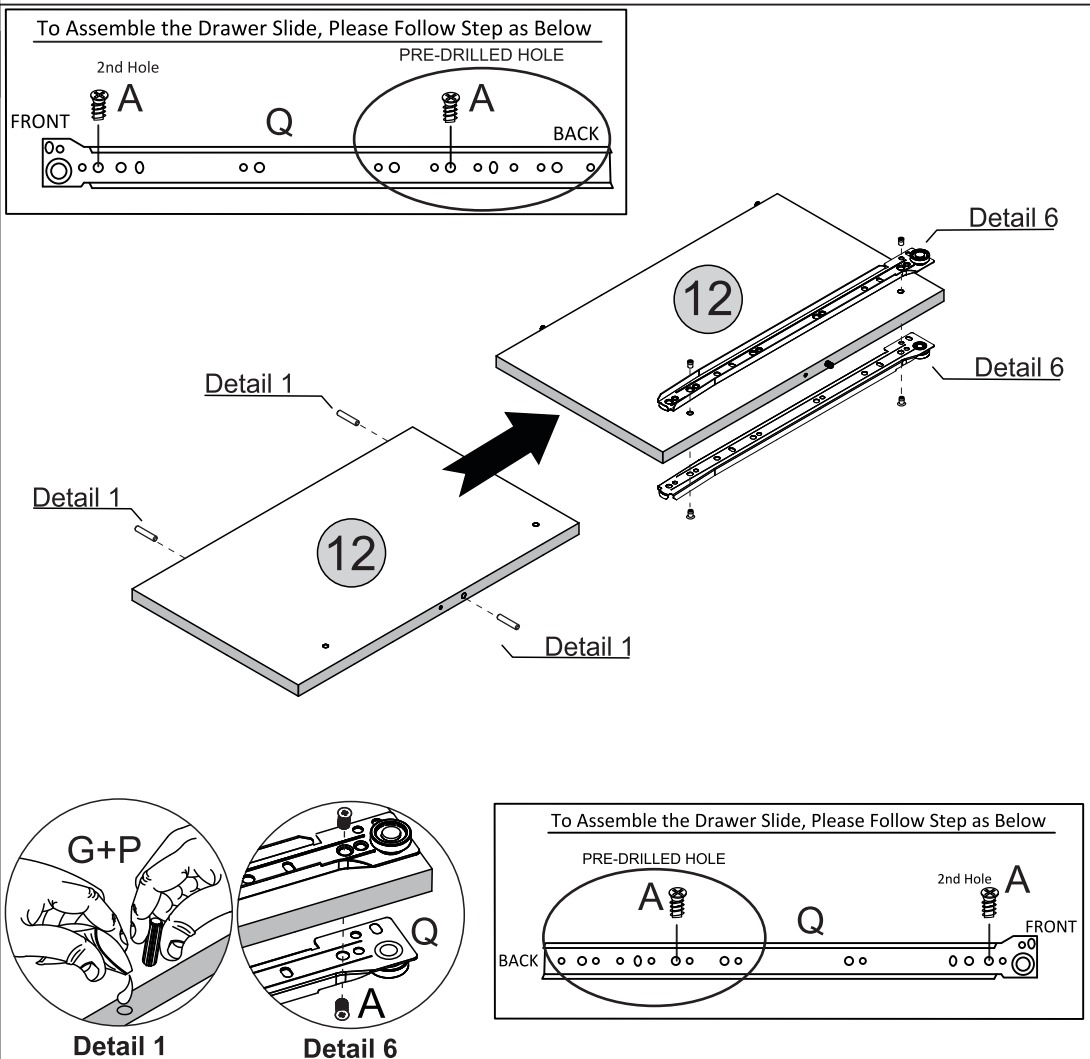
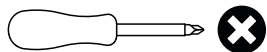



STEP 7

PARTS REQUIRED

2 - RIGHT SIDE PANEL	x1
4 - FRONT BASEBOARD	x1
9 - BACK BASEBOARD	x1
11 - CROSSBAR	x2

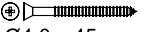
HARDWARE REQUIRED

E		04
Ø4,0 x 45mm		
P		01

TOOLS REQUIRED

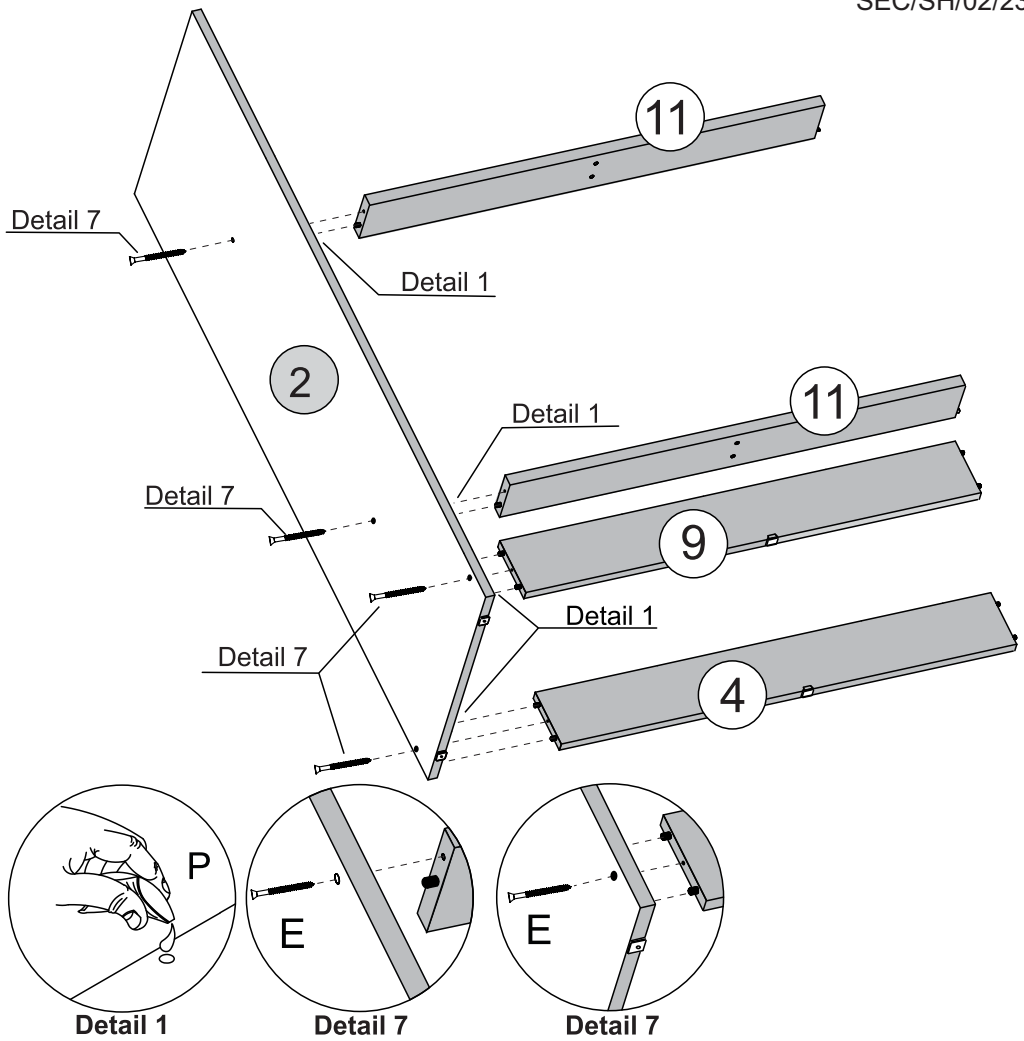
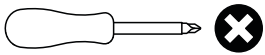



STEP 8

PARTS REQUIRED

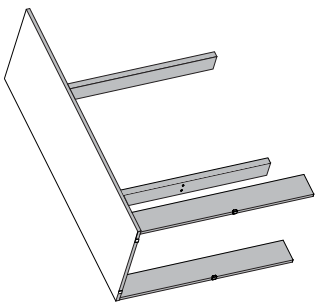
1 - LEFT SIDE PANEL	x1
---------------------	----

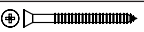

HARDWARE REQUIRED

E		04
Ø4,0 x 45mm		
P		01

TOOLS REQUIRED

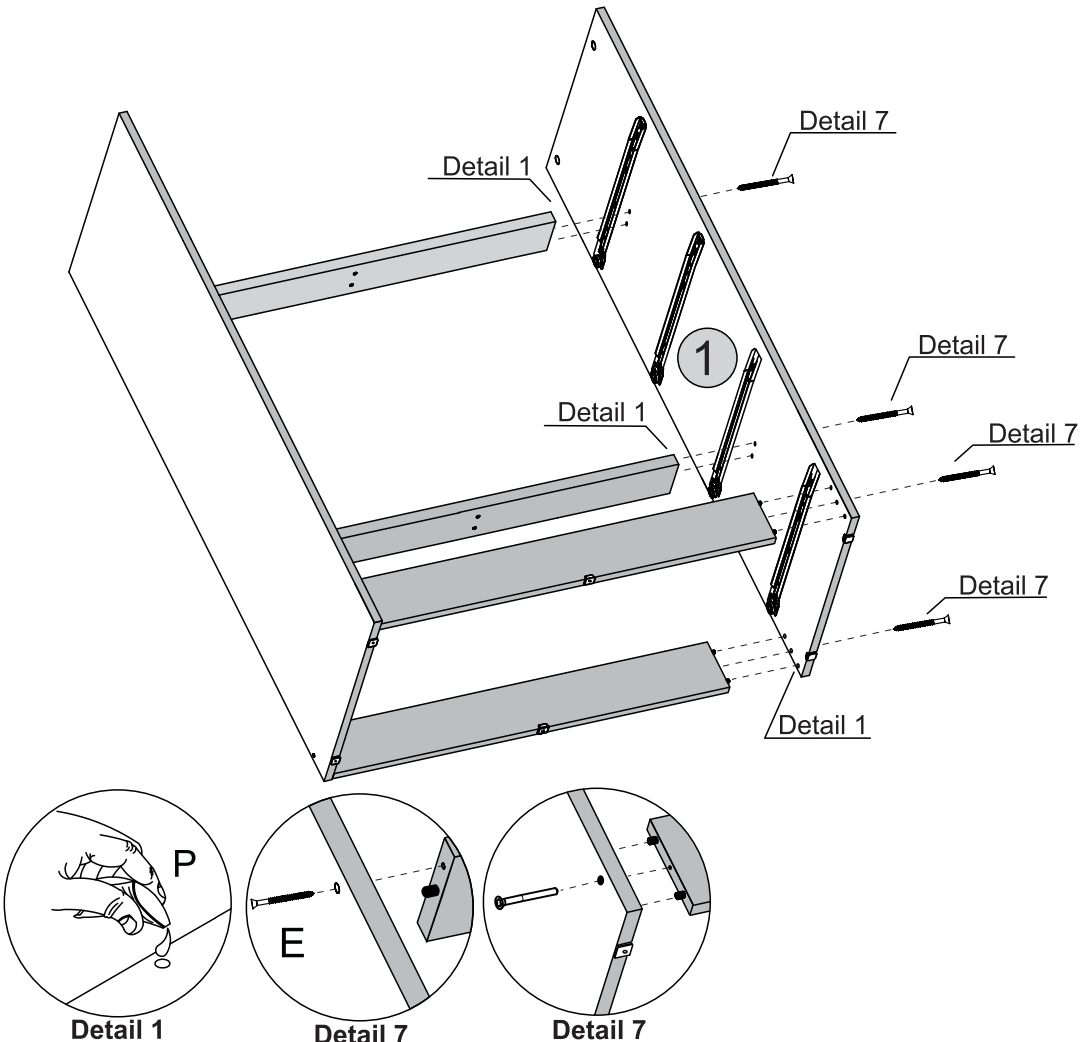
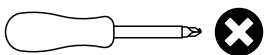

STEP 9

PARTS REQUIRED

3 - TOP PANEL x1

HARDWARE REQUIRED

N  06

TOOLS REQUIRED

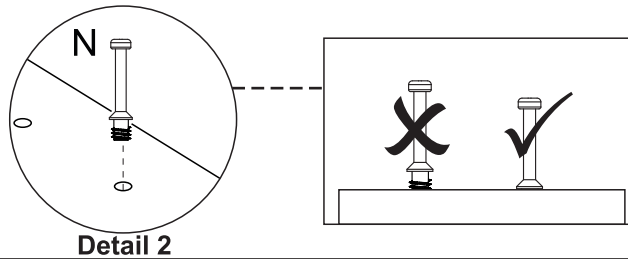
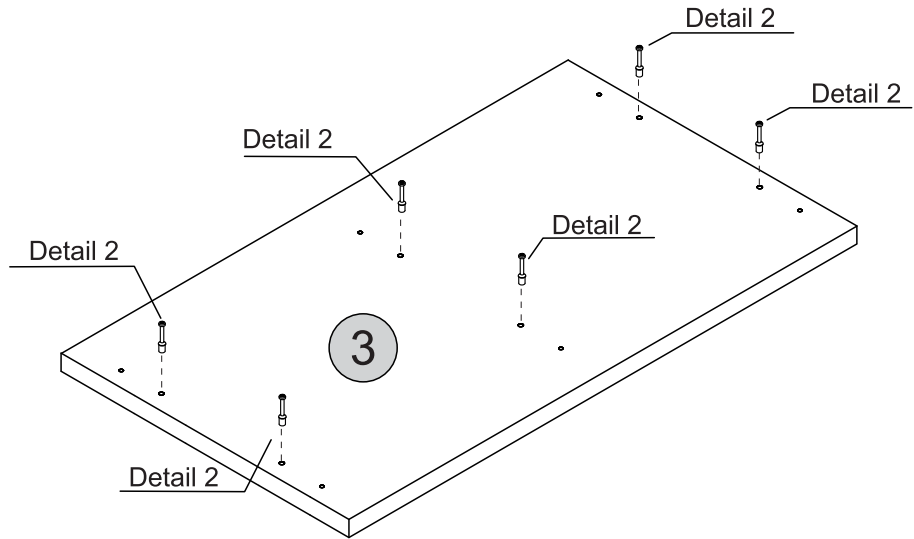
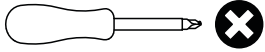

STEP 10

PARTS REQUIRED

3 - TOP PANEL x1

12 - DIVISION PANEL x1

HARDWARE REQUIRED

J  02

P  01

TOOLS REQUIRED

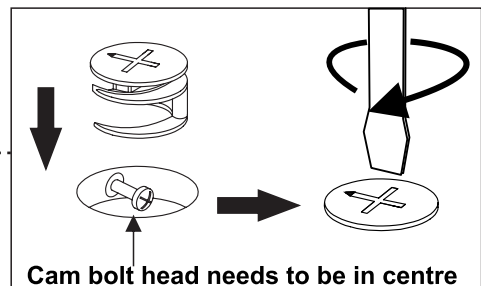
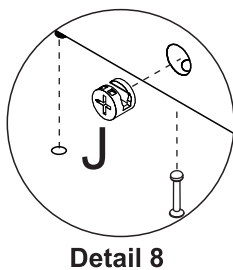
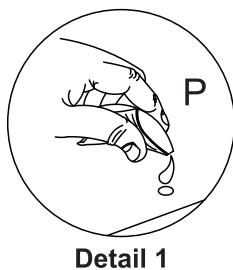
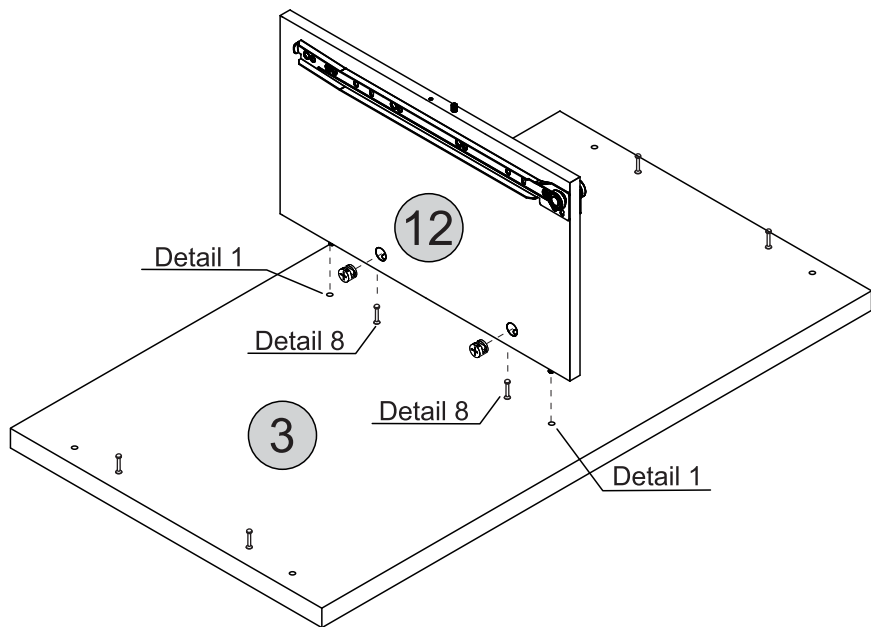
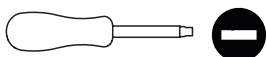

STEP 11

PARTS REQUIRED

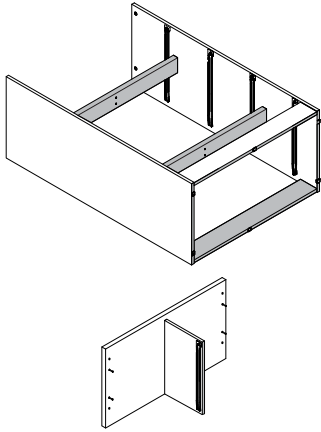

HARDWARE REQUIRED

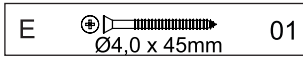

TOOLS REQUIRED

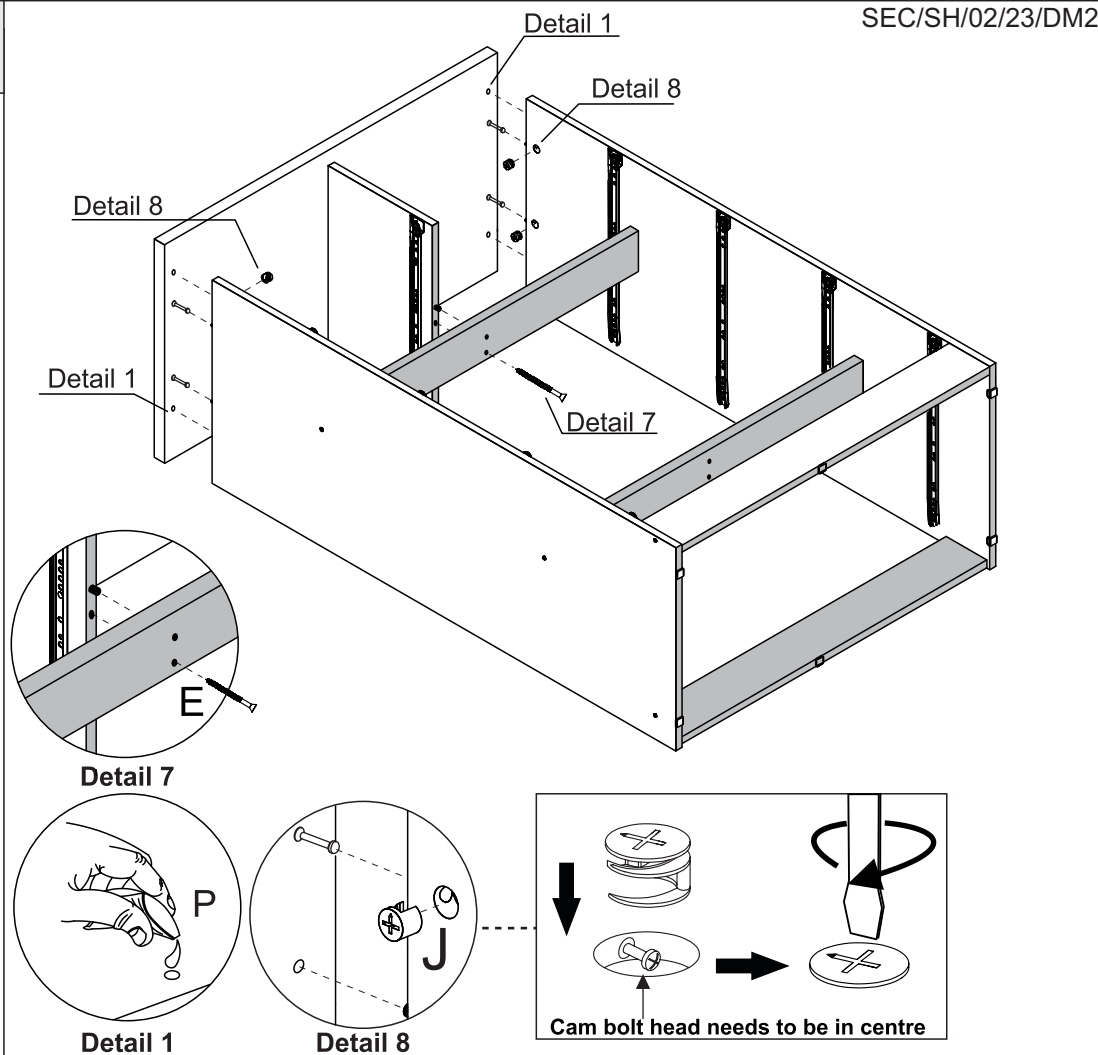
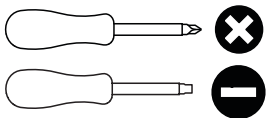

STEP 12

PARTS REQUIRED

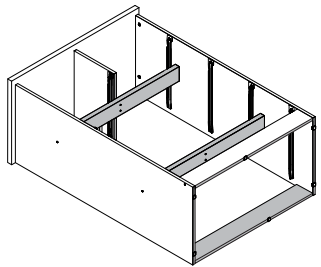

HARDWARE REQUIRED

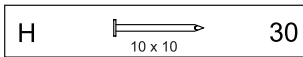
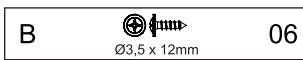

TOOLS REQUIRED

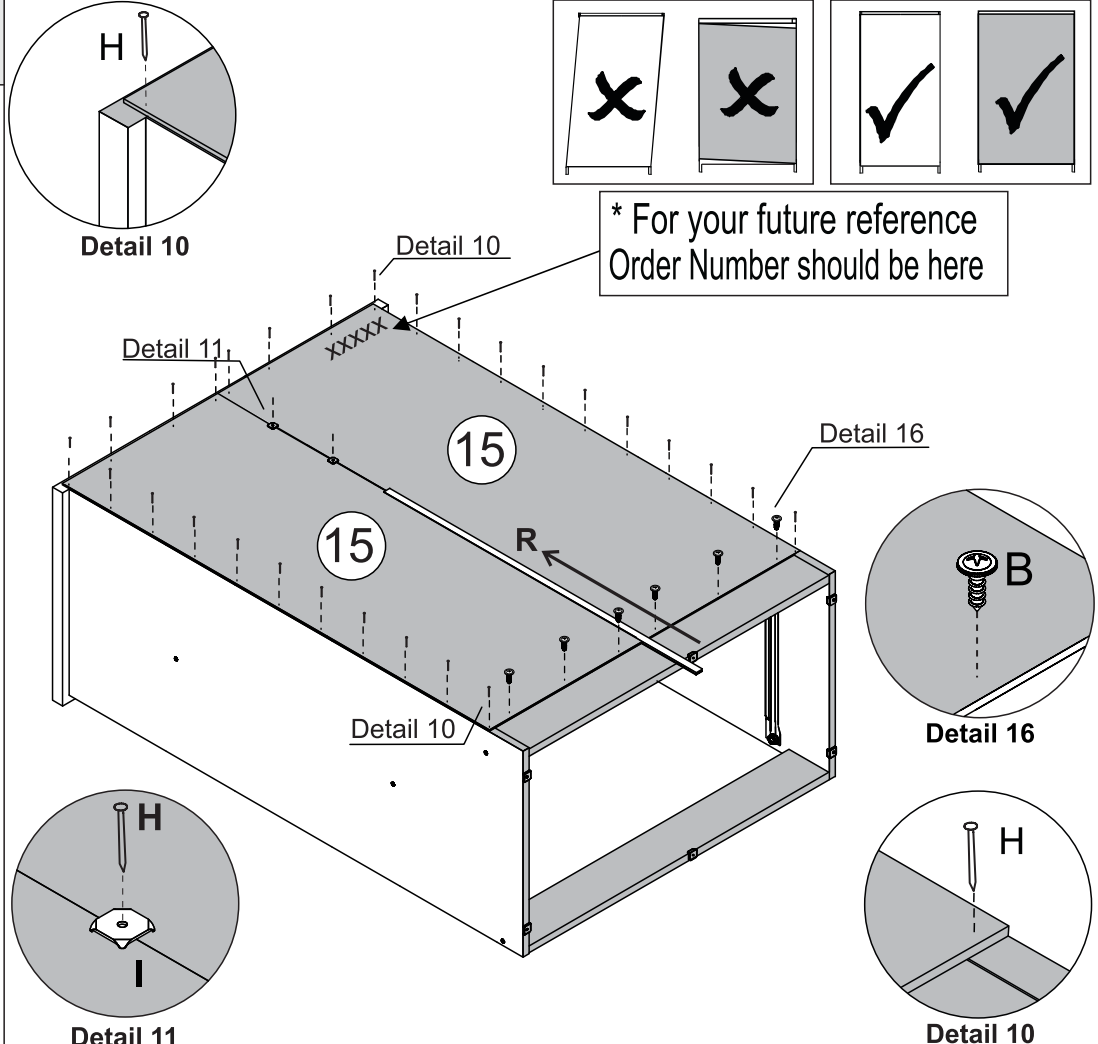
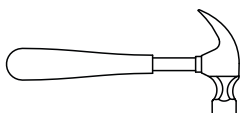

STEP 13

PARTS REQUIRED

6 - DRAWER SIDE x10

7 - SMALL DRAWER BACK PANEL x2

14 - LARGE DRAWER BACK PANEL x3

19 - DRAWER BOTTOM SUPPORT BAR x3

HARDWARE REQUIRED

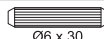
G  46
Ø6 x 30

P  01
GLUE

TOOLS REQUIRED

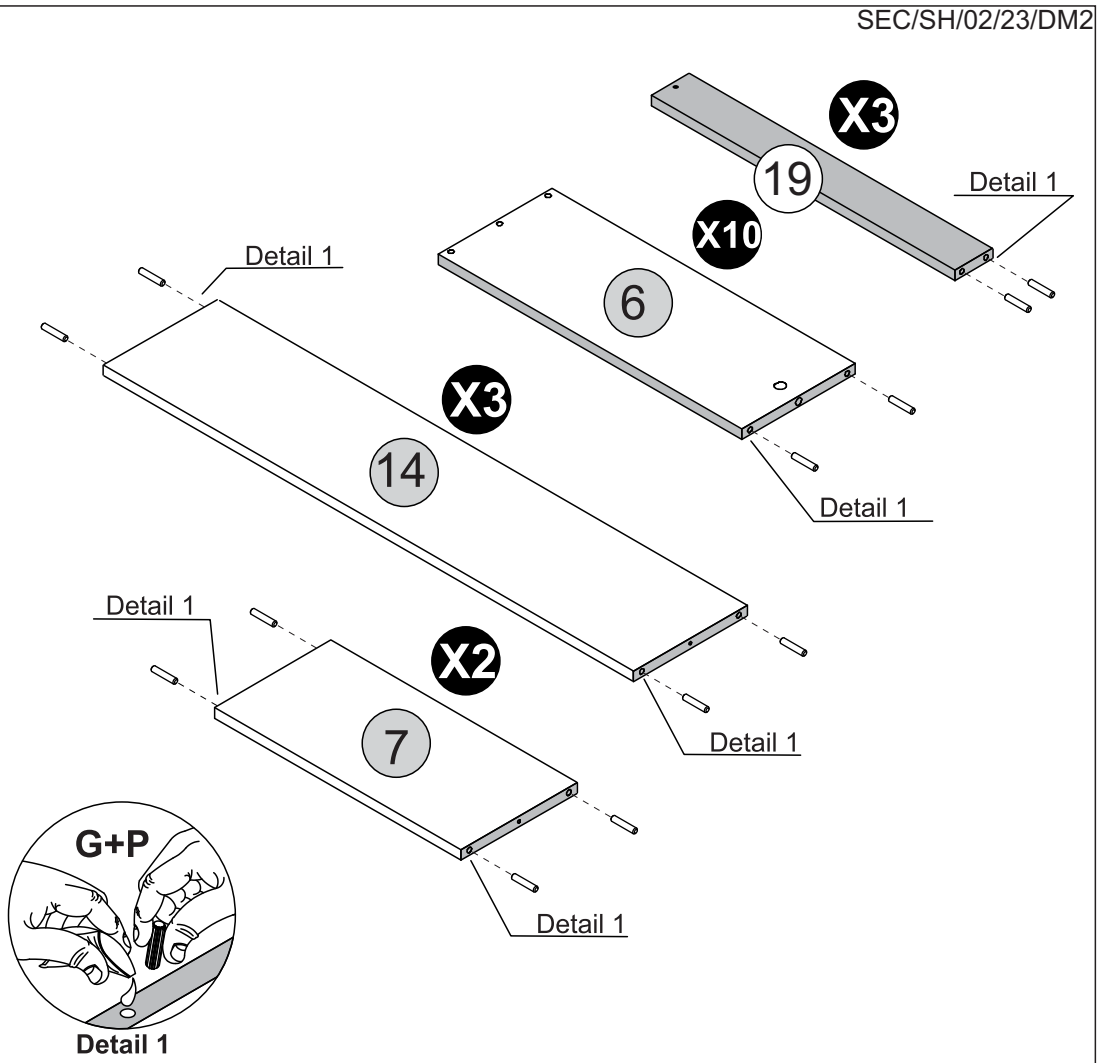

STEP 14

PARTS REQUIRED

5 - SMALL DRAWER FRONT x2

13 - LARGE DRAWER FRONT x3

HARDWARE REQUIRED

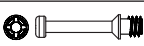
N  10

TOOLS REQUIRED

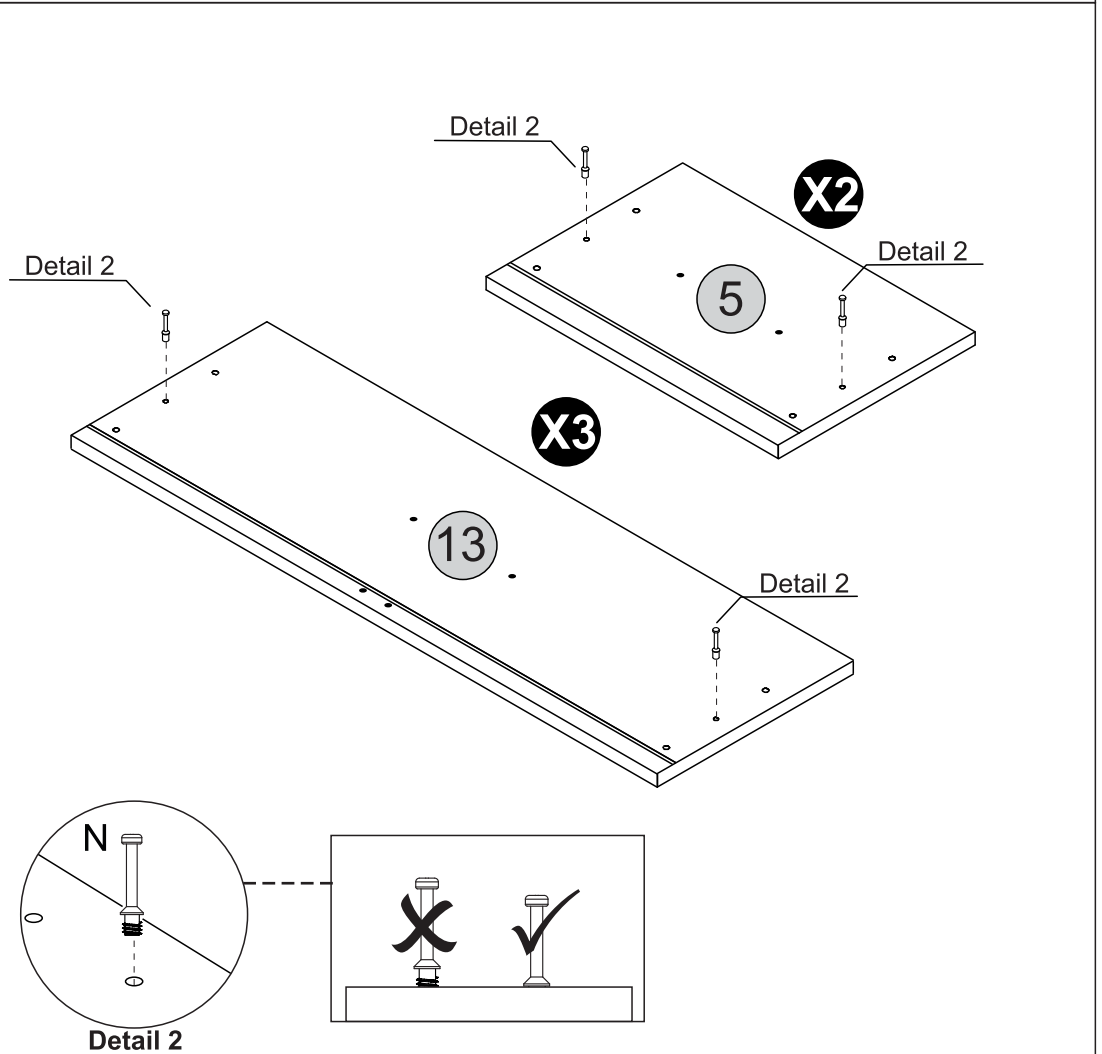
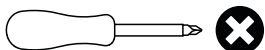

STEP 15

PARTS REQUIRED

6 - DRAWER SIDE x6

14 - LARGE DRAWER BACK PANEL x3

HARDWARE REQUIRED

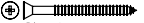
E  06
Ø4,0 x 45mm

TOOLS REQUIRED

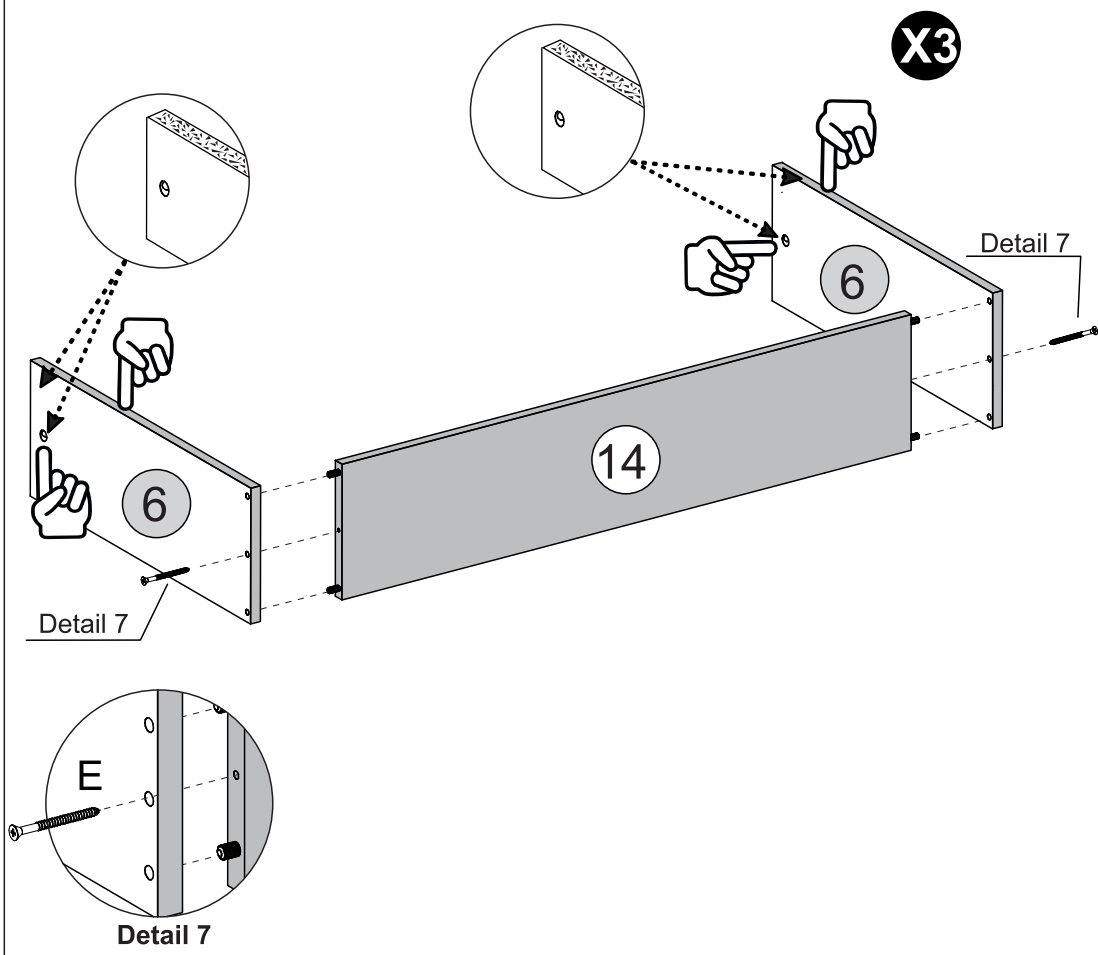
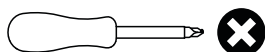

STEP 16

PARTS REQUIRED

13 - LARGE DRAWER FRONT x3

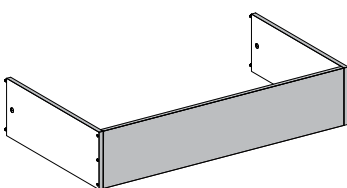

HARDWARE REQUIRED

P  01

TOOLS REQUIRED

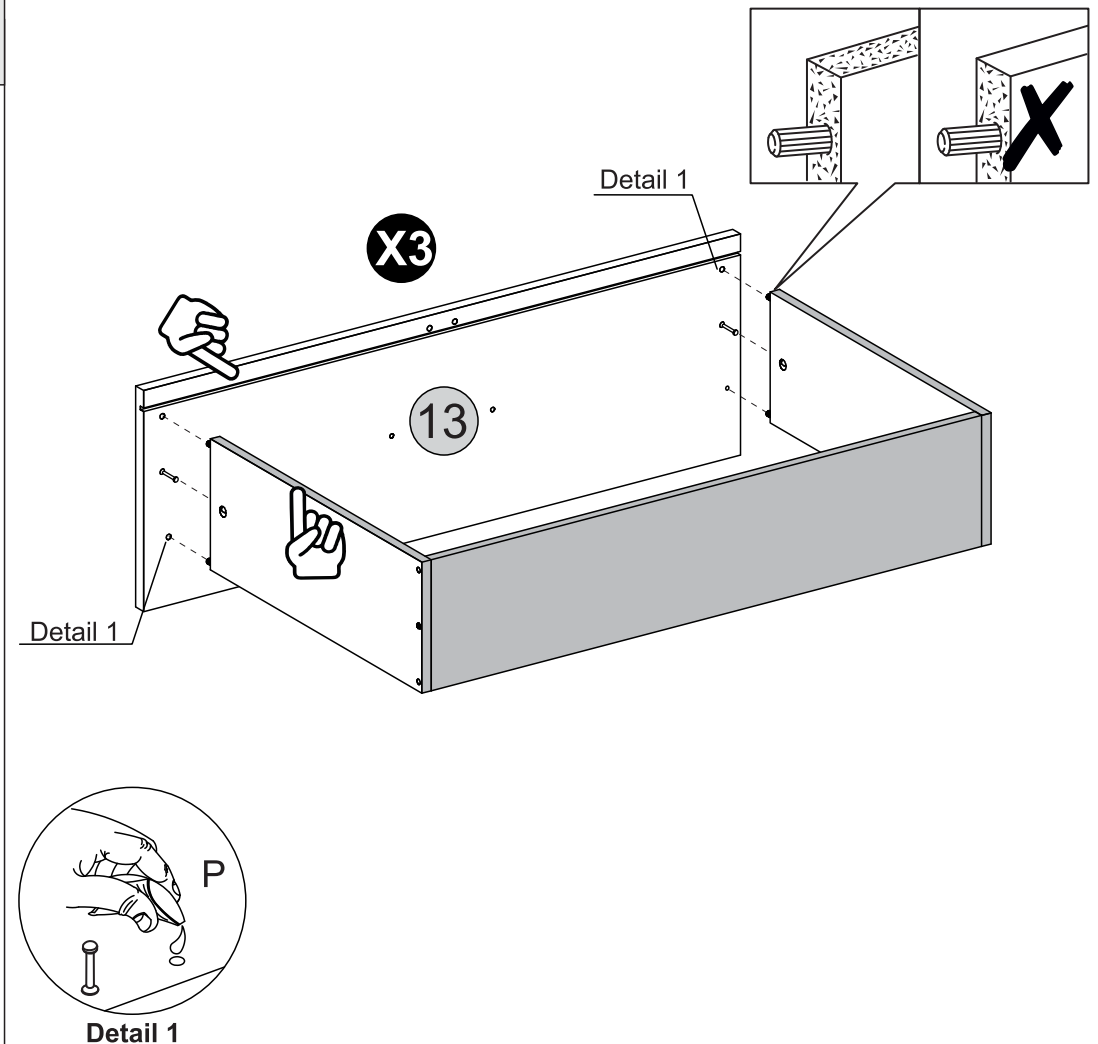
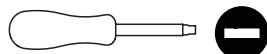

STEP 17

PARTS REQUIRED

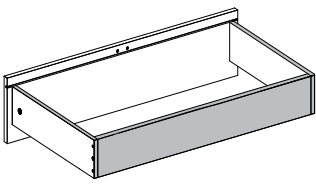

HARDWARE REQUIRED



TOOLS REQUIRED

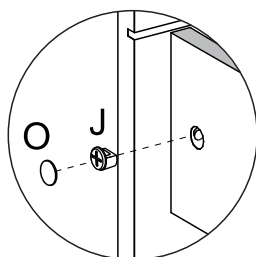
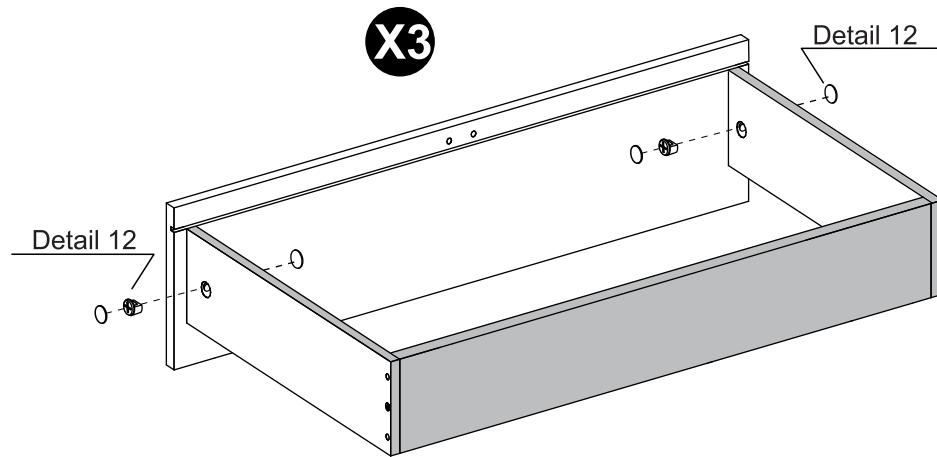
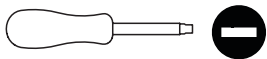

Detail 12

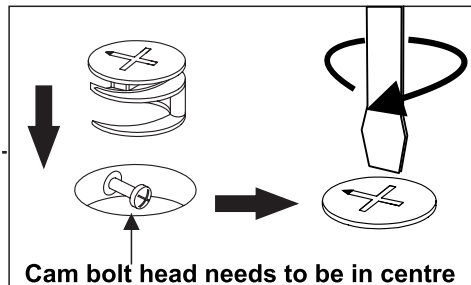

STEP 18

PARTS REQUIRED

18 LARGE DRAWER BOTTOM x3

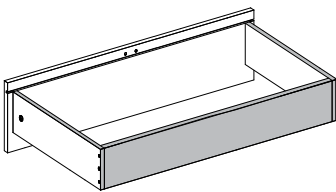

HARDWARE REQUIRED

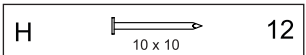

TOOLS REQUIRED

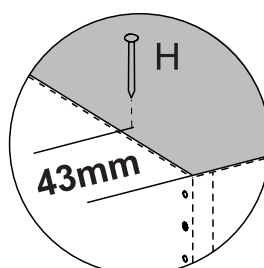
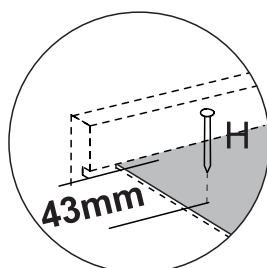
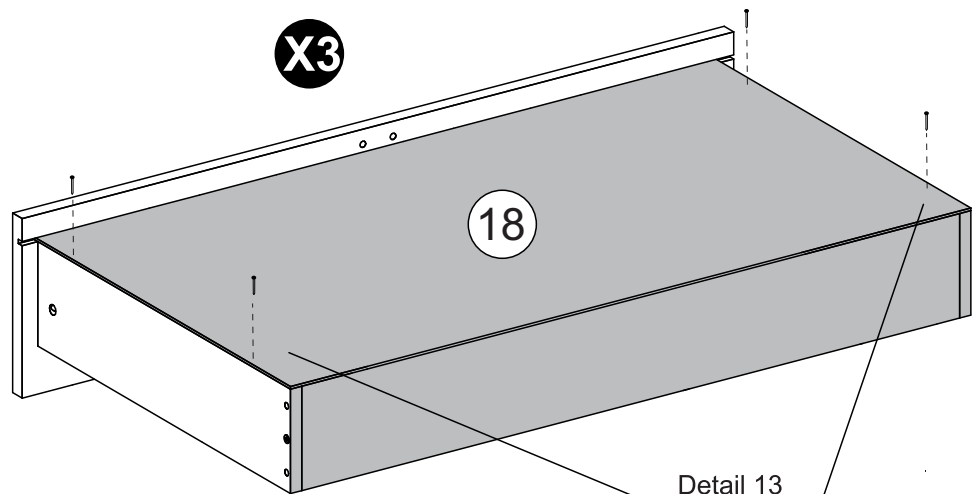
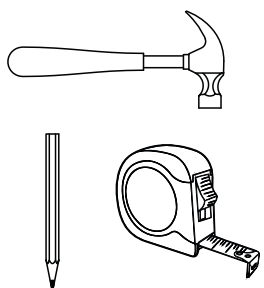

Detail 13

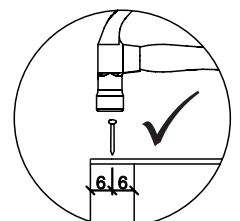
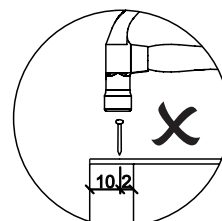
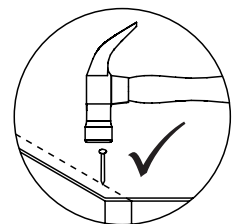
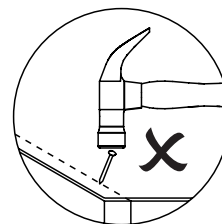

STEP 19

PARTS REQUIRED

19 - DRAWER BOTTOM SUPPORT BAR X3

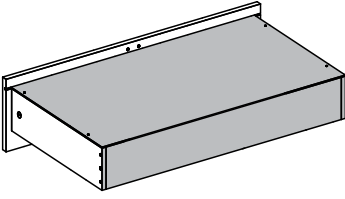

HARDWARE REQUIRED

H  18
10 x 10

P  01
GLUE

TOOLS REQUIRED

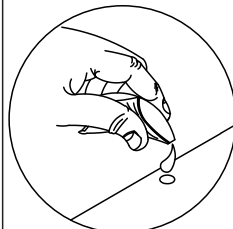
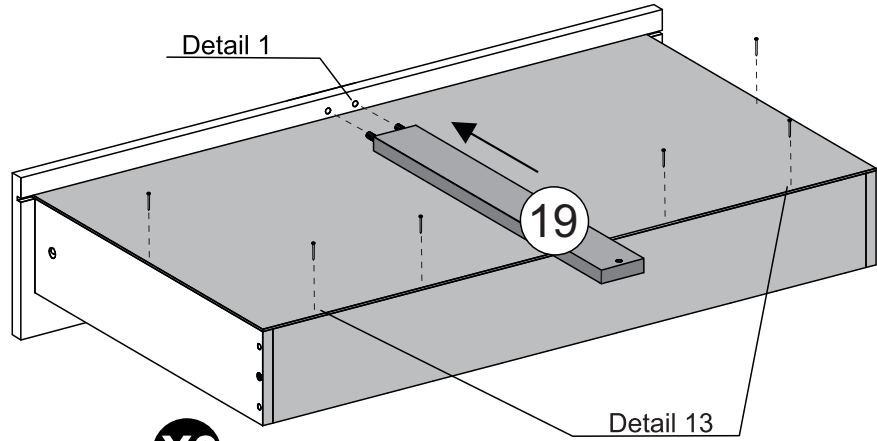
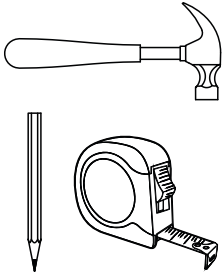

Detail 1

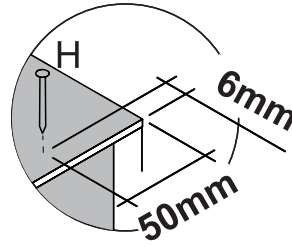

Detail 13

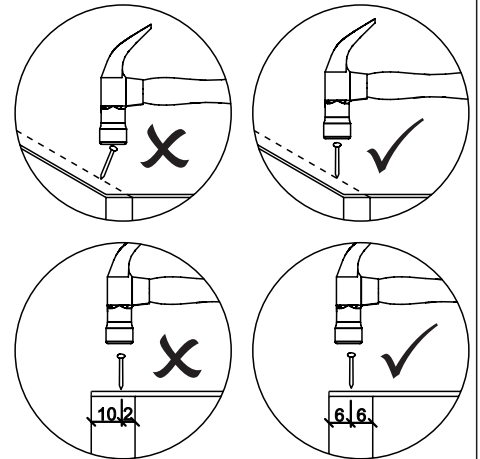

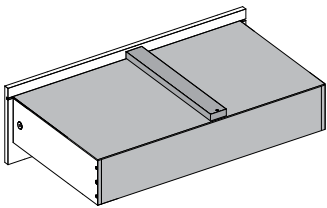

STEP 20

PARTS REQUIRED



HARDWARE REQUIRED

C  12
Ø4,0 x 14mm

T  03
Ø3,5 x 25mm

Q  03
LEFT

Q  03
RIGHT

TOOLS REQUIRED

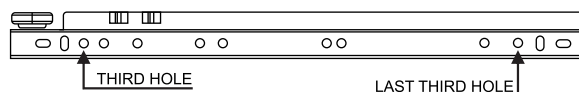
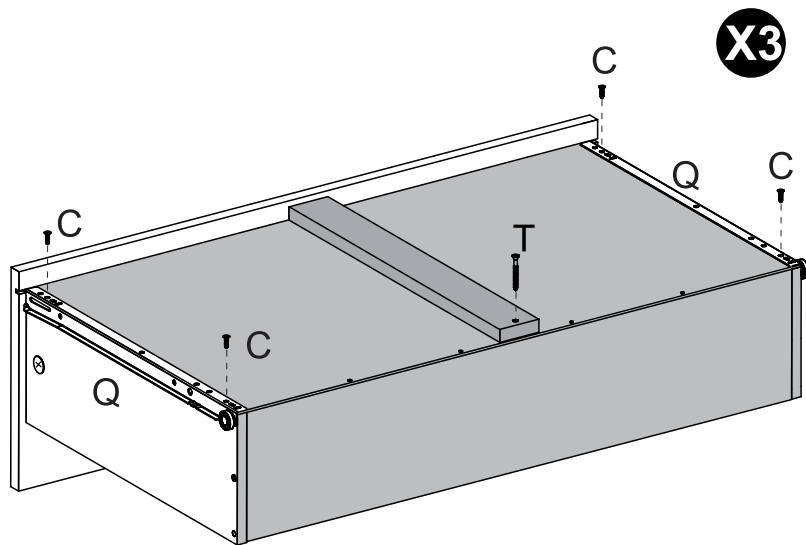
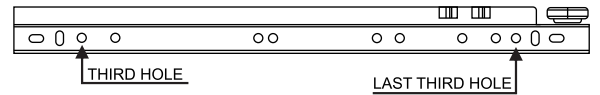
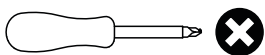

STEP 21

PARTS REQUIRED

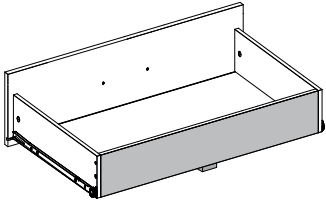

HARDWARE REQUIRED

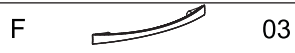

TOOLS REQUIRED

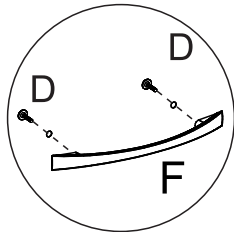
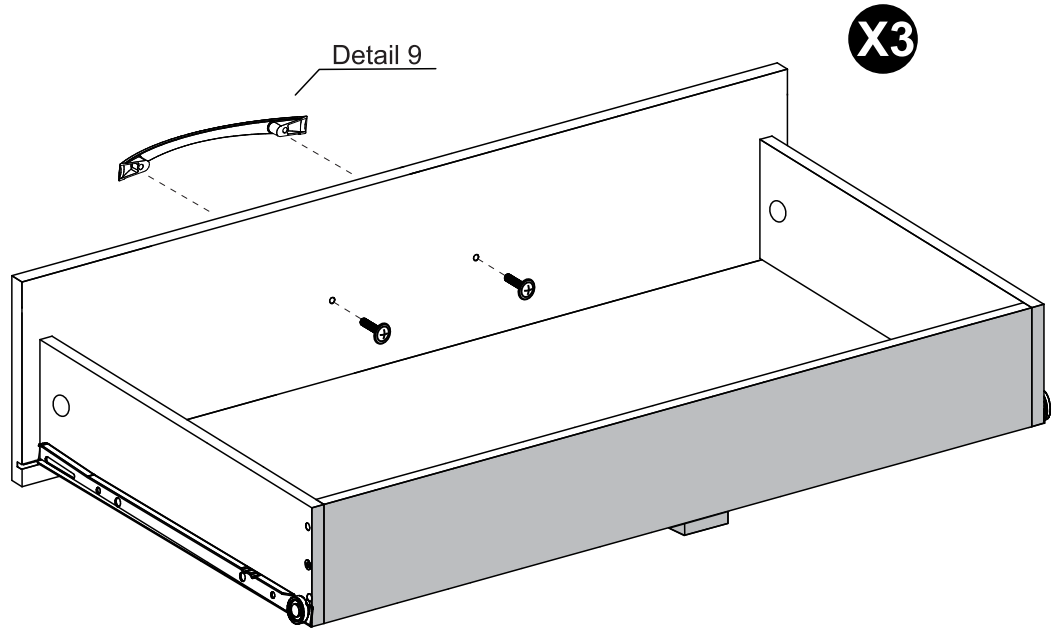
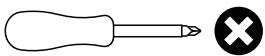

Detail 9

STEP 22

PARTS REQUIRED

6 - DRAWER SIDE x4

7 - SMALL DRAWER BACK PANEL x2

HARDWARE REQUIRED

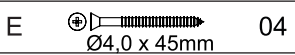

TOOLS REQUIRED

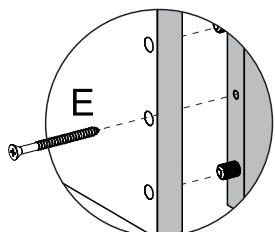
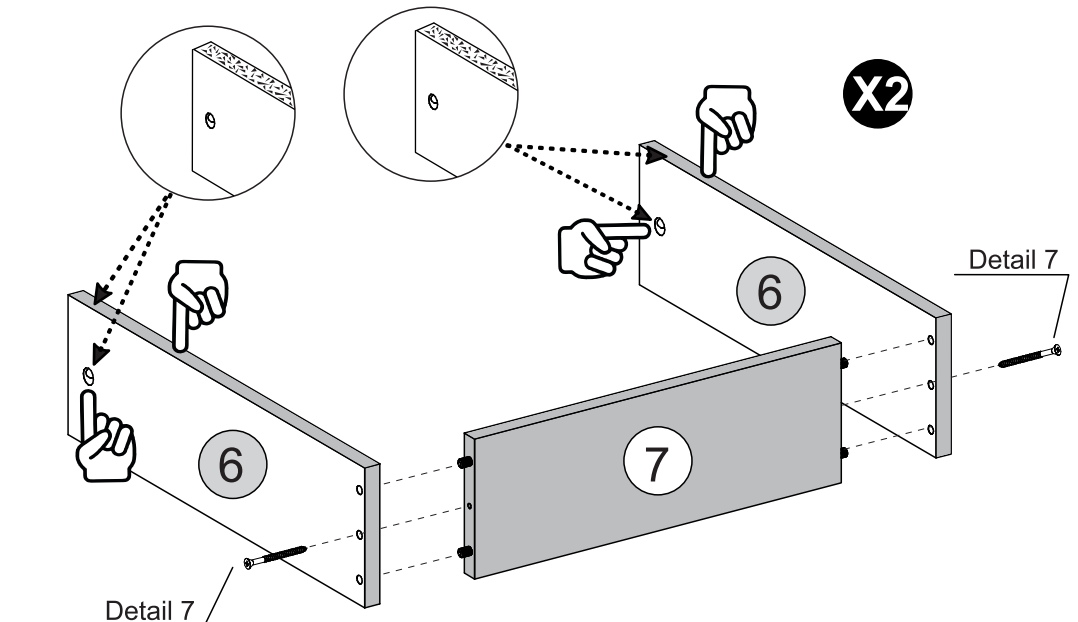
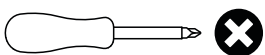

Detail 7

STEP 23

PARTS REQUIRED

5 - SMALL DRAWER FRONT x3

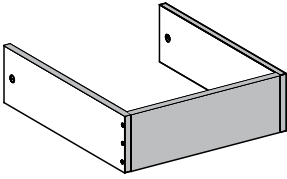

HARDWARE REQUIRED

P  01

TOOLS REQUIRED

X2

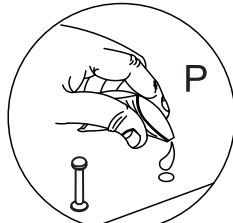
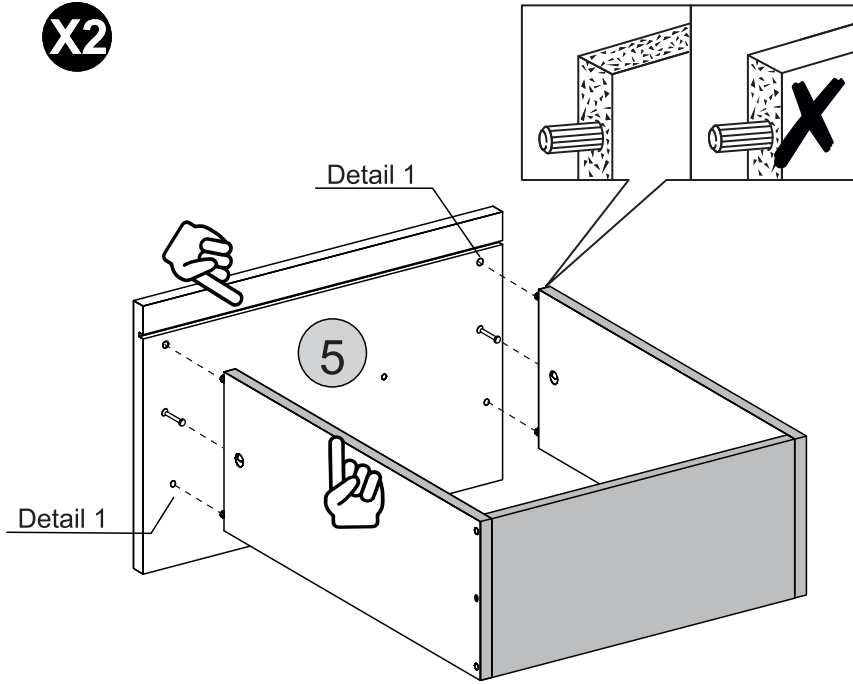

Detail 1

STEP 24

PARTS REQUIRED

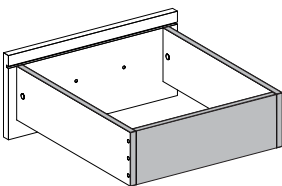

HARDWARE REQUIRED

J  04

O  08

TOOLS REQUIRED

X2

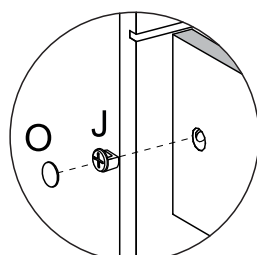
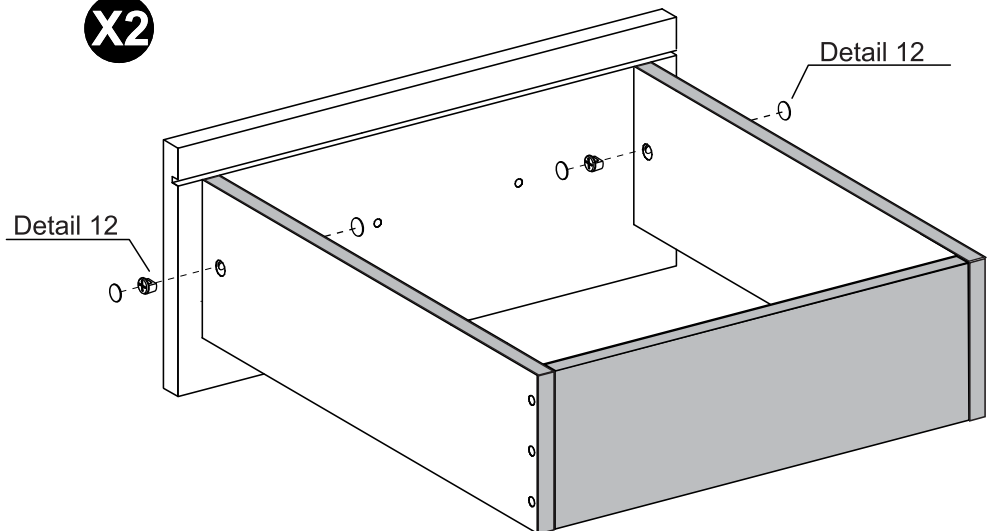

Detail 12

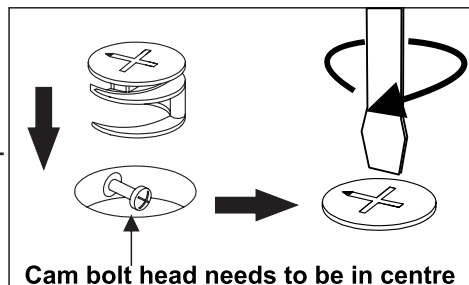

STEP 25

PARTS REQUIRED

8 - SMALL DRAWER BOTTOM x2

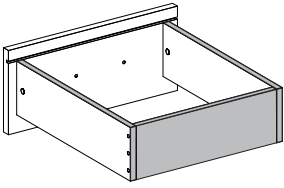

HARDWARE REQUIRED

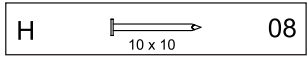

TOOLS REQUIRED

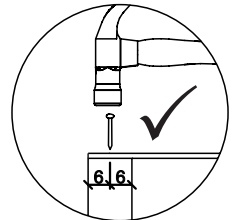
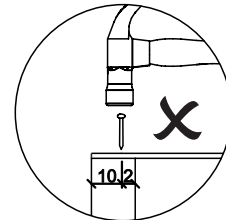
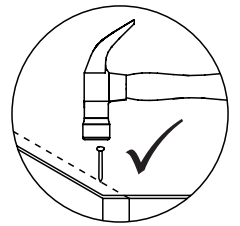
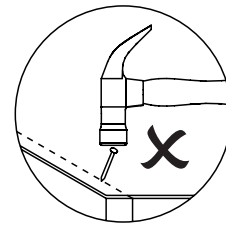
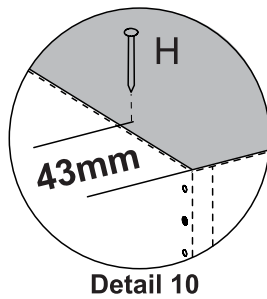
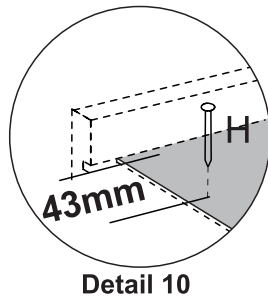
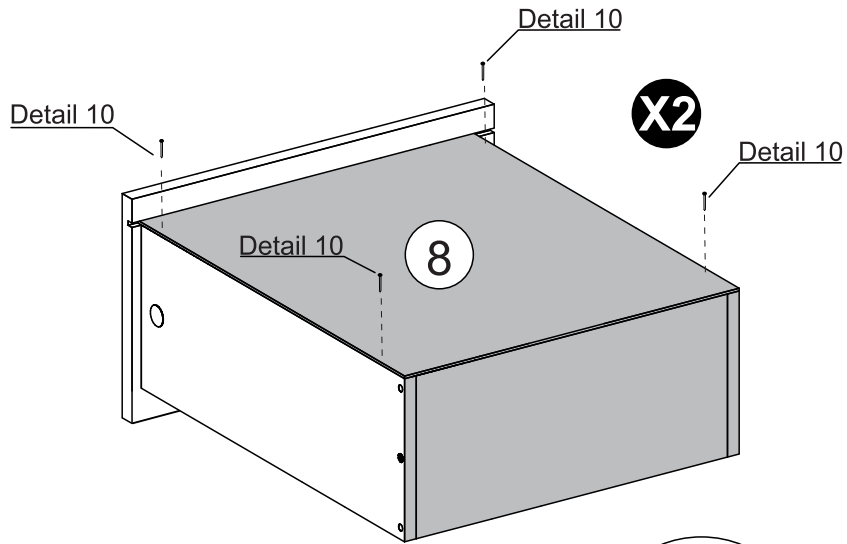
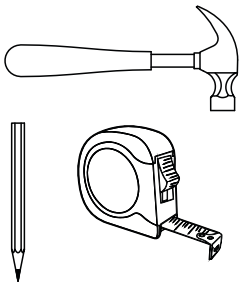

STEP 26

PARTS REQUIRED

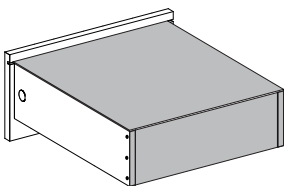

HARDWARE REQUIRED

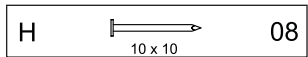

TOOLS REQUIRED

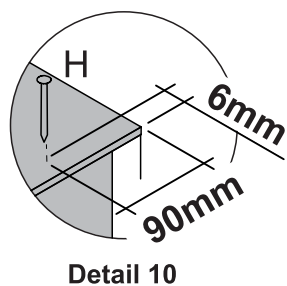
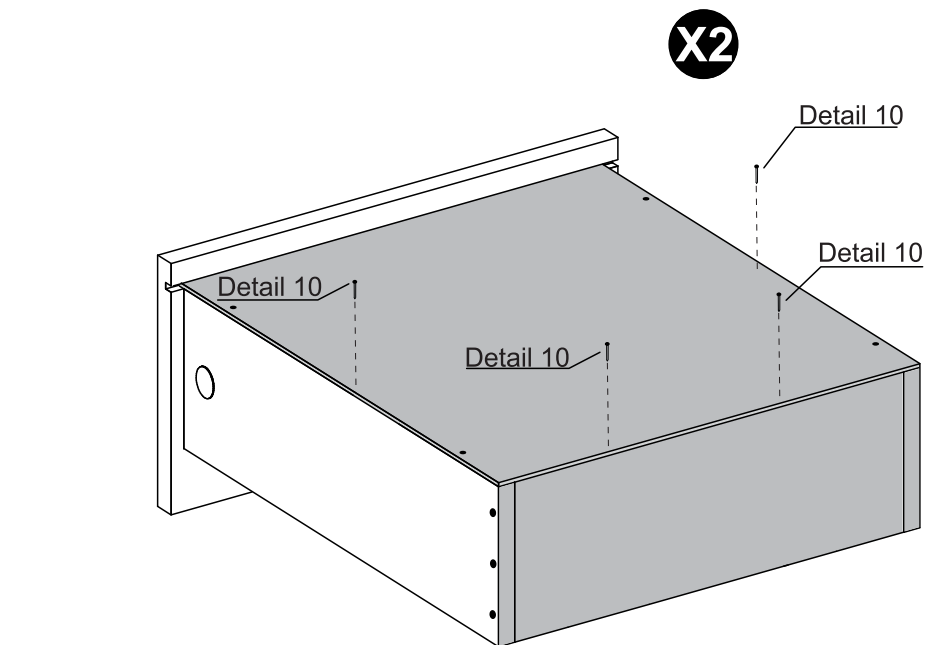
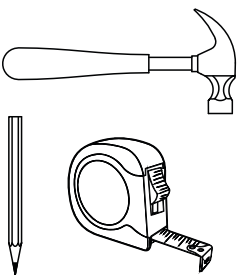

STEP 27

PARTS REQUIRED

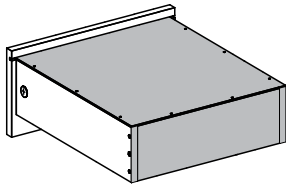

HARDWARE REQUIRED

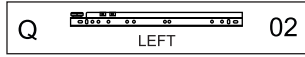
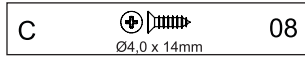

TOOLS REQUIRED

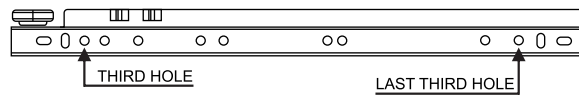
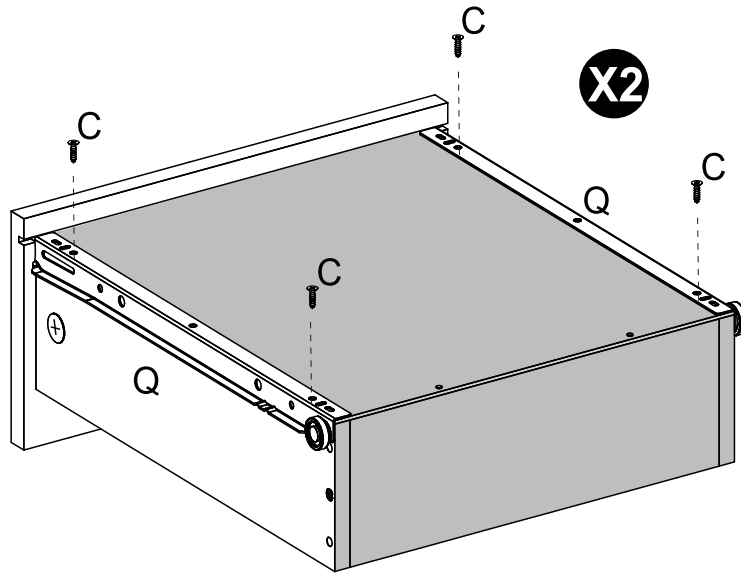
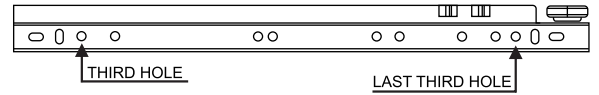
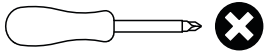

STEP 28

PARTS REQUIRED

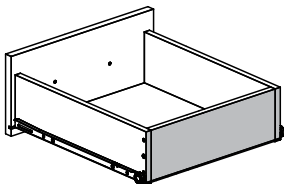

HARDWARE REQUIRED



TOOLS REQUIRED

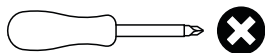

X2

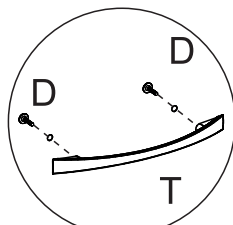
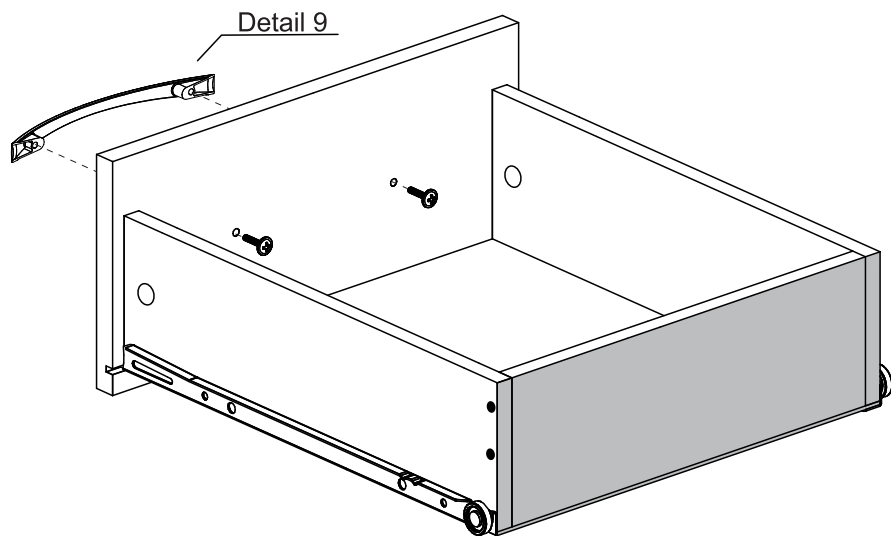

Detail 9

STEP 29

PARTS REQUIRED

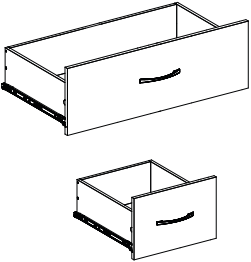
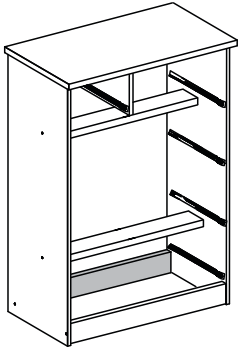

HARDWARE REQUIRED

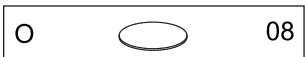

TOOLS REQUIRED

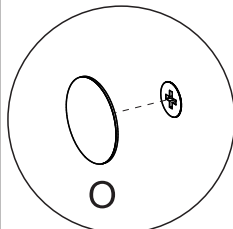
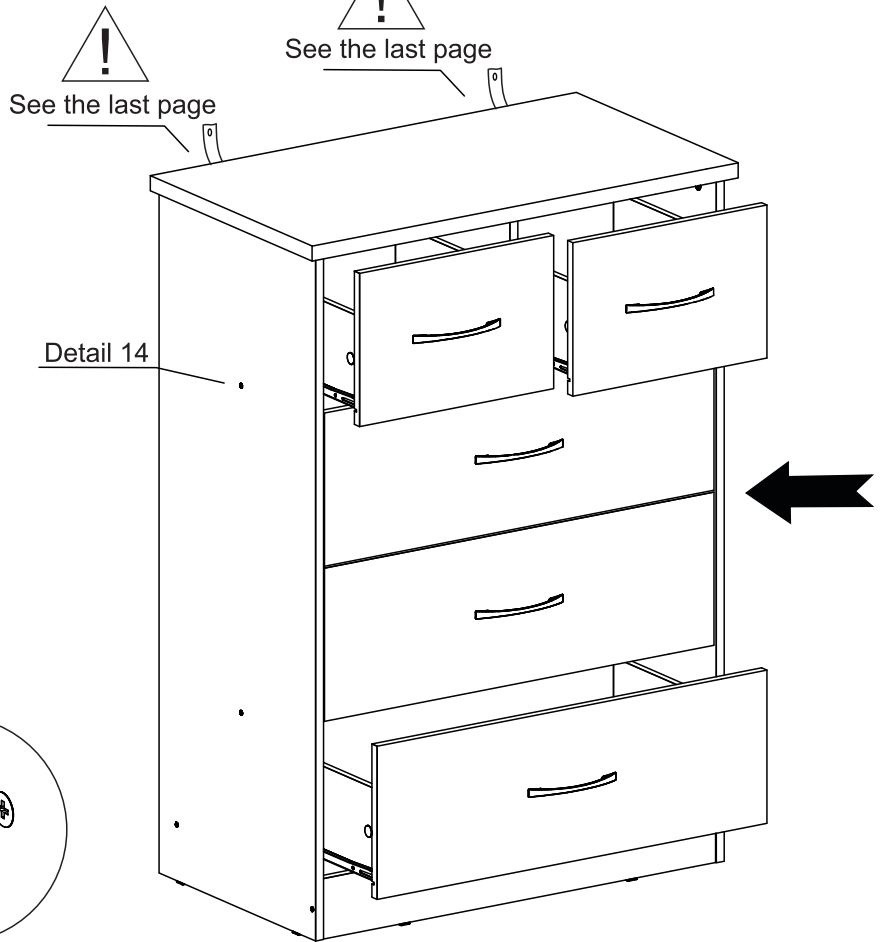

Detail 14

STEP 30

PARTS REQUIRED

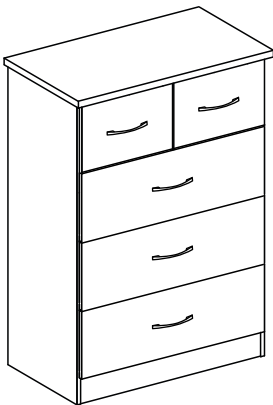

HARDWARE REQUIRED

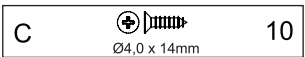

TOOLS REQUIRED

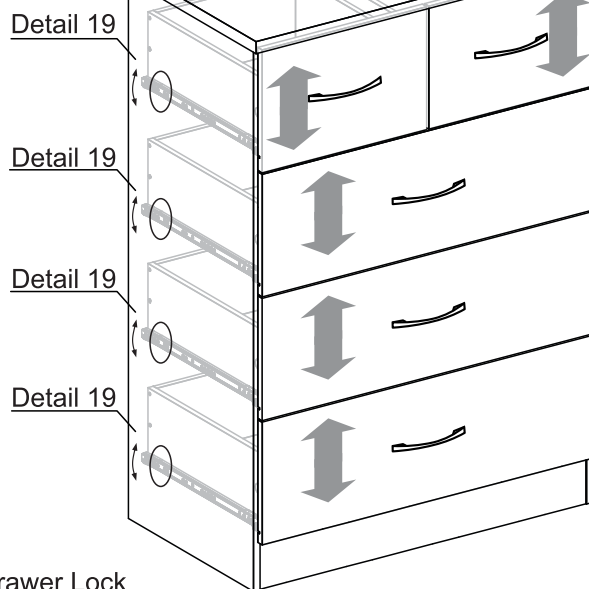

TIP
If desired, after assembly use an alcohol cleaner to erase the number printed on the parts.

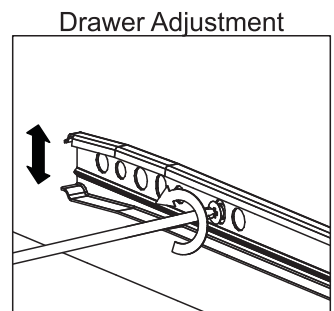

Detail 19

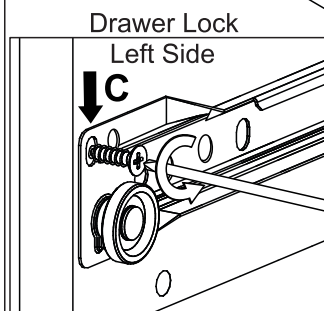

Detail 18

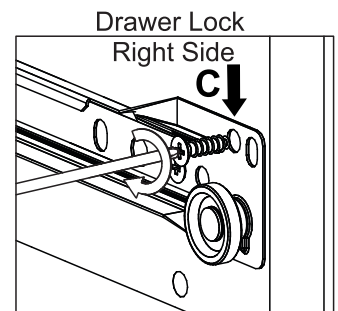

Detail 15

WARNING

Serious or fatal injuries can occur from furniture tipping over. To prevent the furniture from tipping over we recommend that it is permanently fixed to the wall.

Wall fixings are not supplied with this product as different wall materials require different types of fixing devices.

Please make sure you use fixings suitable for the walls in your home.

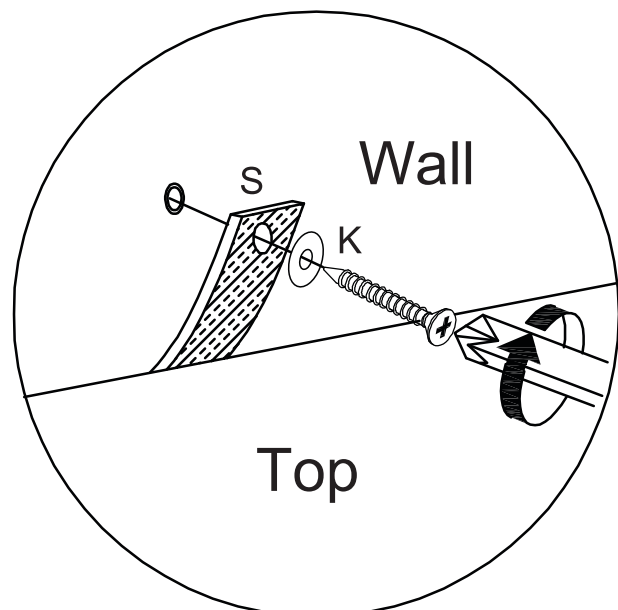
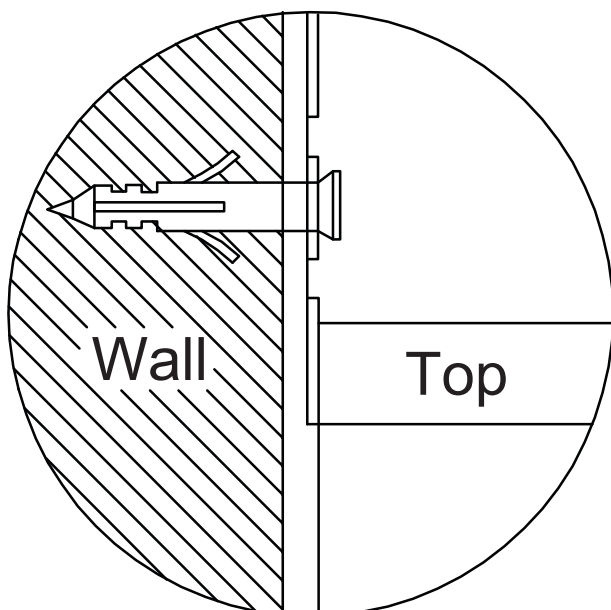
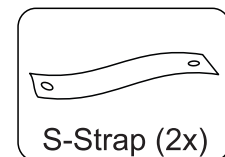
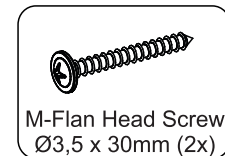
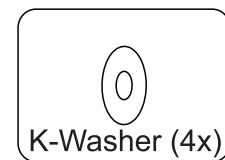
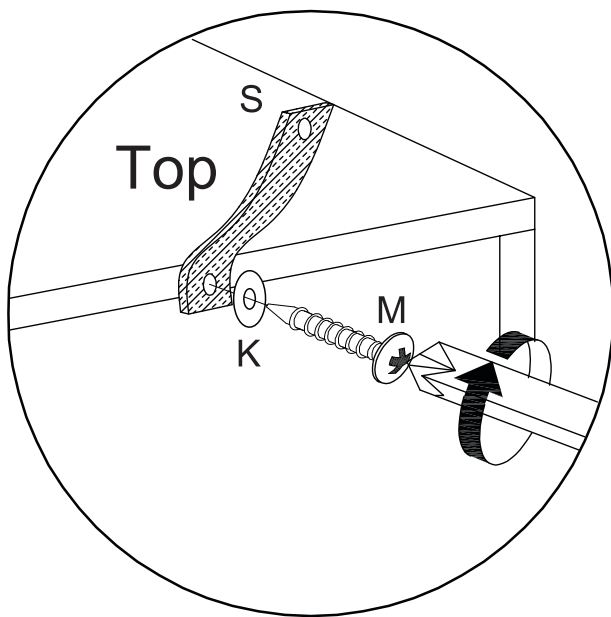

NEVADA 3 DRAWER BEDSIDE ASSEMBLY INSTRUCTIONS

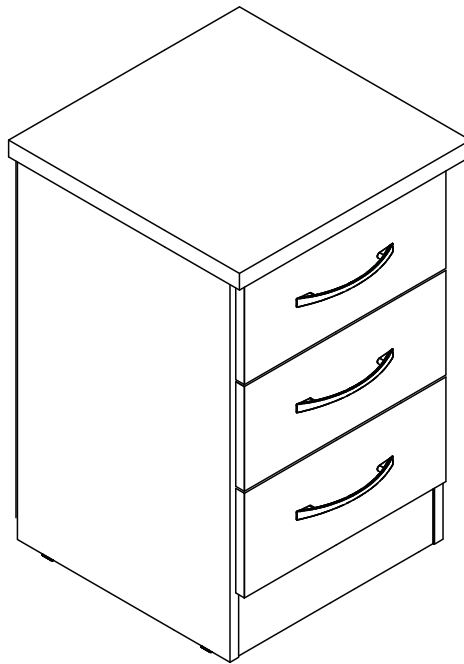

IMPORTANT FOR DOMESTIC USE ONLY

PLEASE READ BEFORE YOU CONTINUE FURTHER

CARE AND MAINTENANCE

After unpacking this product please keep the original packaging in case it needs to be returned for any reason.

- Please ensure all fittings and parts are present before commencing with assembly.
- Never drag or push products as this could cause damage to the joints making it inferior.
- We strongly recommend that you keep children away from your work area.
- We recommend that you lay a blanket or sheet on the floor to avoid damage to both your floor and the product.
- Assemble this product as close to its final position as possible.
- Do not place this product next to a radiator or in direct sunlight.
- Do not drag or push items across your high gloss furniture as this may cause the surface to scratch
- Wood is a natural product and may expand if subjected to damp and may shrink or crack if subjected to heat. Therefore it is recommended that room temperature is maintained, with no sudden temperature fluctuations.
- Make sure any spillage is wiped off immediately.
- Do not place hot or chilled items directly on to the surface, use a place mat or marking will occur.
- For general cleaning use a soft cotton or micro fibre cloth, and do not use detergents of any kind.
- From time to time it may be necessary to tighten fittings, regular inspections should be carried out.
- Do not place on a wet or damp floor as staining may occur to your floor.

TOOLS REQUIRED

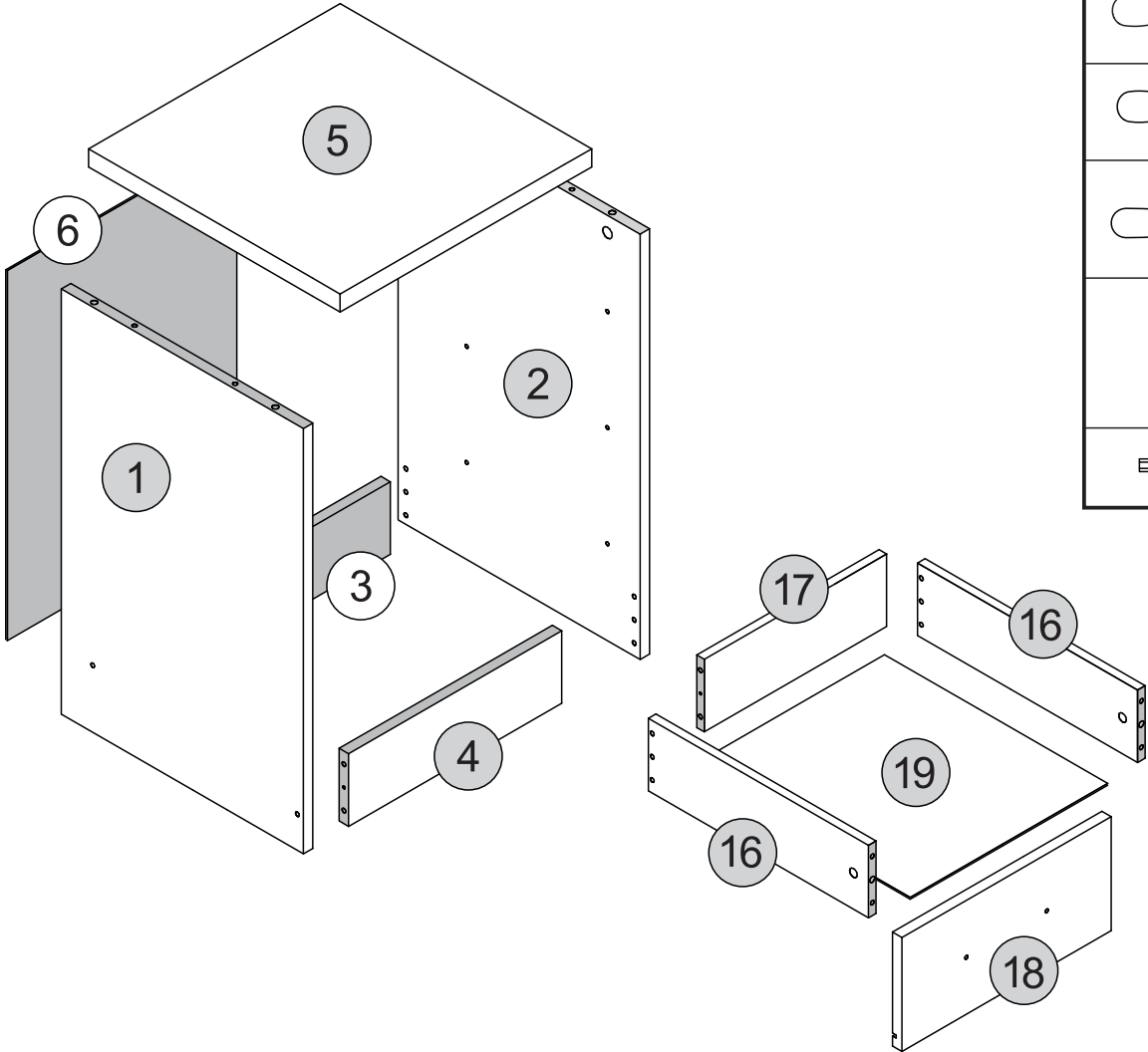
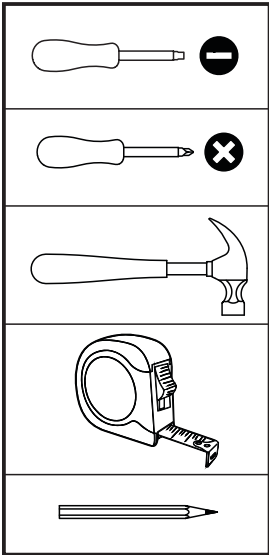







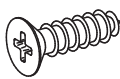
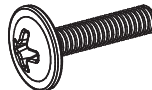

PARTS LIST

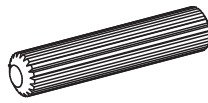
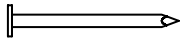
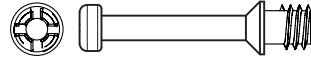
Please Note:
The below parts have all been stamped with the part number to help identify them during assembly.

Part Number	Part Description	Quantity	Carton
1	Left Side Panel	1	1/1
2	Right Side Panel	1	1/1
3	Back Baseboard	1	1/1
4	Front Baseboard	1	1/1
5	Top Panel	1	1/1
6	Back Panel	1	1/1
16	Drawer Side	6	1/1
17	Drawer Back Panel	3	1/1
18	Drawer Front	3	1/1
19	Drawer Bottom	3	1/1



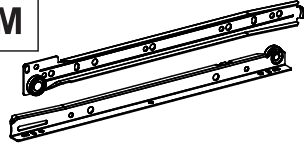
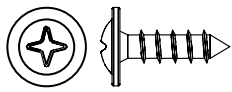

FITTINGS LIST

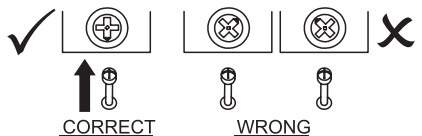

<p>A</p>  <p>Flat Head Screw Ø6,0 x 8mm (12x)</p> <p>2/+</p>	<p>B</p>  <p>Flat Head Screw Ø4,0 x 14mm (18x)</p> <p>2/+</p>	<p>C</p>  <p>Flan Head Screw Ø4,0 x 20mm (6x)</p> <p>1/+</p>	<p>D</p>  <p>Flat Head Screw Ø4,0 x 45mm (10x)</p> <p>1/+</p>
<p>E</p>  <p>Dowel Ø6,0 x 30mm (36x)</p> <p>2/+</p>	<p>F</p>  <p>Nail 10 x 10 (40x)</p> <p>5/+</p>	<p>G</p>  <p>Cam Bolt (10x)</p> <p>1/+</p>	<p>H</p>  <p>Cam Nut Ø12mm (10x)</p> <p>1/+</p>
<p>I</p>  <p>Plastic Foot (4x)</p> <p>1/+</p>	<p>J</p>  <p>Hole Plugs (16x)</p> <p>2/+</p>	<p>K</p>  <p>GLUE</p> <p>Glue (2x)</p>	<p>L</p>  <p>Handle (3x)</p>
<p>M</p>  <p>Drawer Runners (3x)</p>	<p>N</p>  <p>Flan Head Screw Ø3,5 x 12mm (2x)</p> <p>1/+</p>		

TIPS FOR FITTINGS CAM-LOCKS

WHEN FITTING CAM NUT, ENSURE STARTING POSITION IS CORRECT BEFORE YOU INSERT CONNECTING CAM BOLT TURN CLOCKWISE UNTIL SECURE



CORRECT WRONG

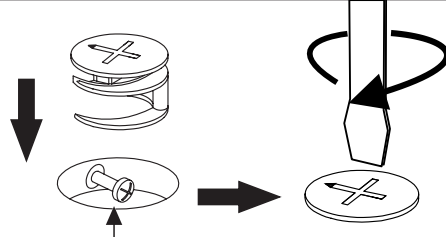

Cam bolt head needs to be in centre

CAMBOLT

Tighten until shoulder in flush with panel. Do not overtighten or undertighten (see example beside)

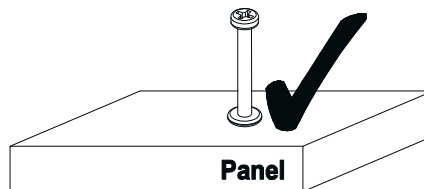
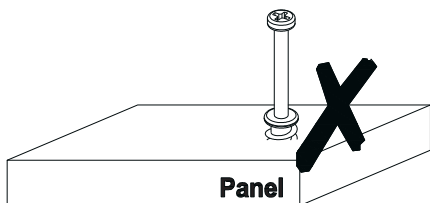
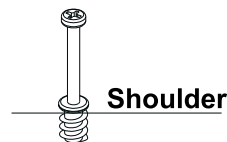



STEP 1

PARTS REQUIRED

1 - LEFT SIDE PANEL x1

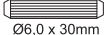
HARDWARE REQUIRED

E  02
Ø6,0 x 30mm

F  02
10 x 10

I  02

K  01

TOOLS REQUIRED

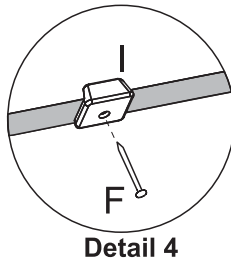
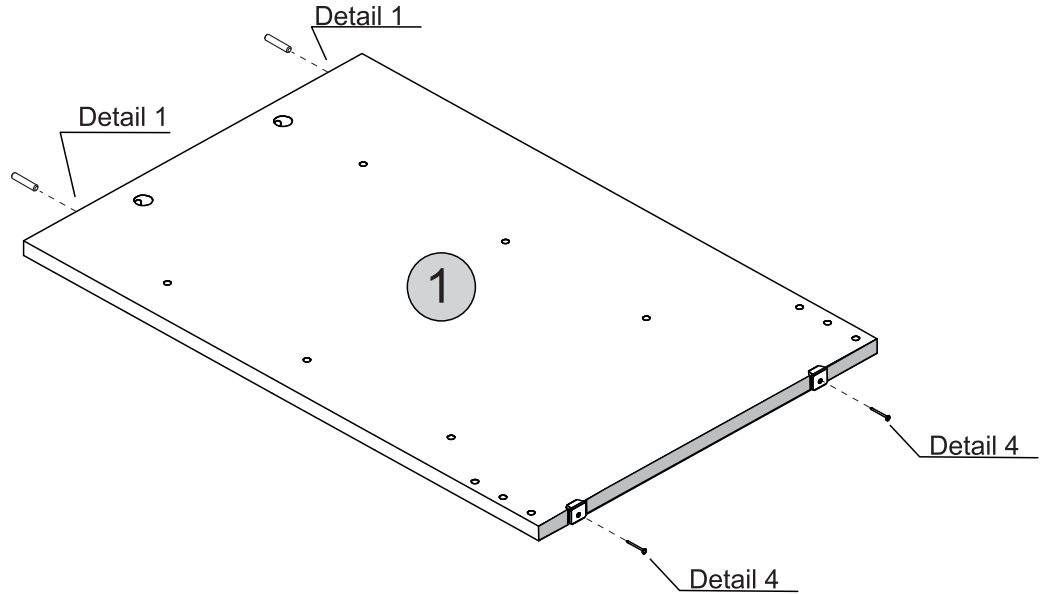
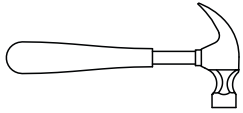



STEP 2

PARTS REQUIRED

2 - RIGHT SIDE PANEL x1

HARDWARE REQUIRED

E  02
Ø6,0 x 30mm

F  02
10 x 10

I  02

K  01

TOOLS REQUIRED

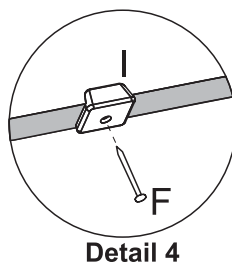
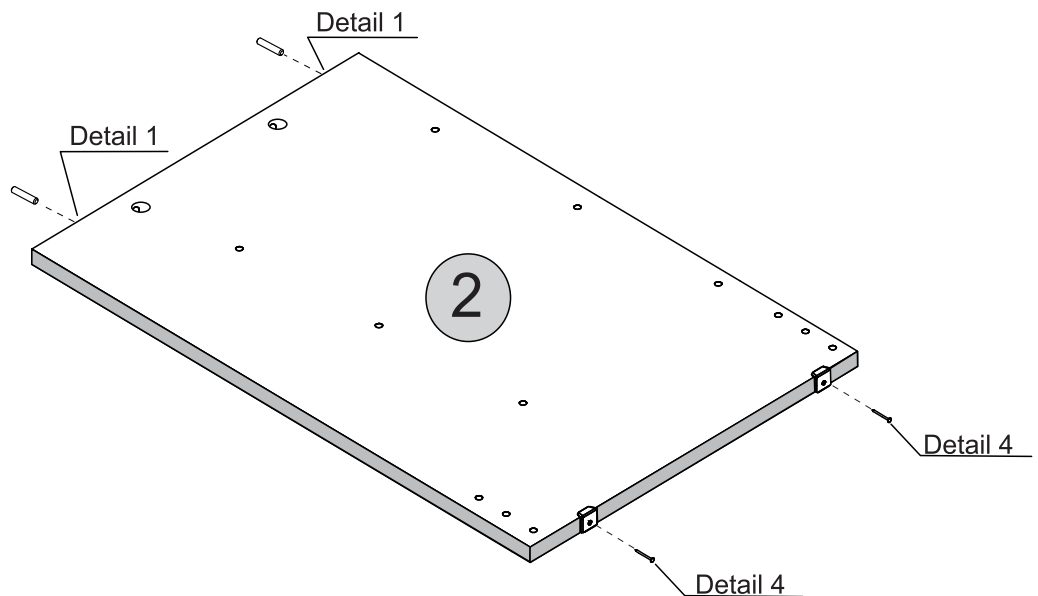
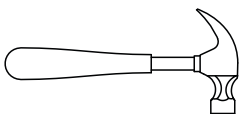



STEP 3

PARTS REQUIRED

2 - RIGHT SIDE PANEL x1

HARDWARE REQUIRED

- A  06
Ø6,0 x 8mm
- M  03

TOOLS REQUIRED

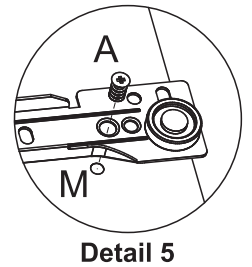
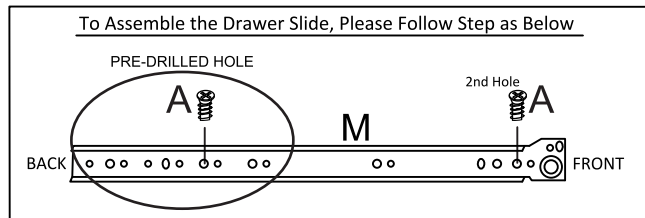
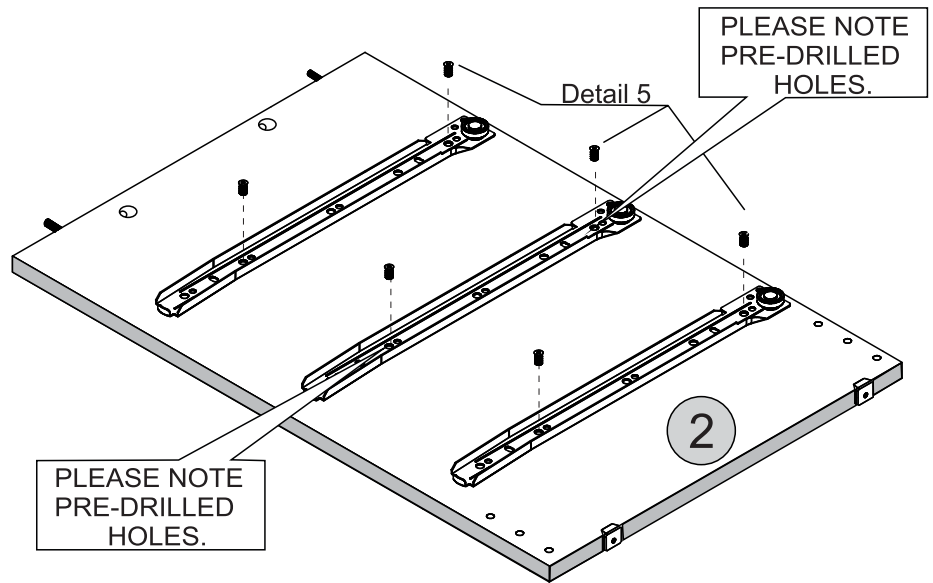
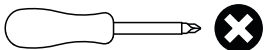



STEP 4

PARTS REQUIRED

1 - LEFT SIDE PANEL x1

HARDWARE REQUIRED

- A  06
Ø6,0 x 8mm
- M  03

TOOLS REQUIRED

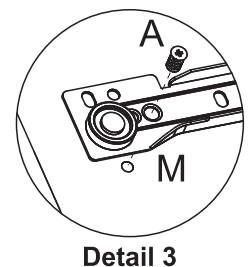
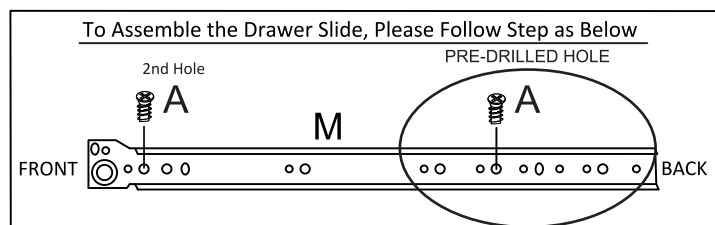
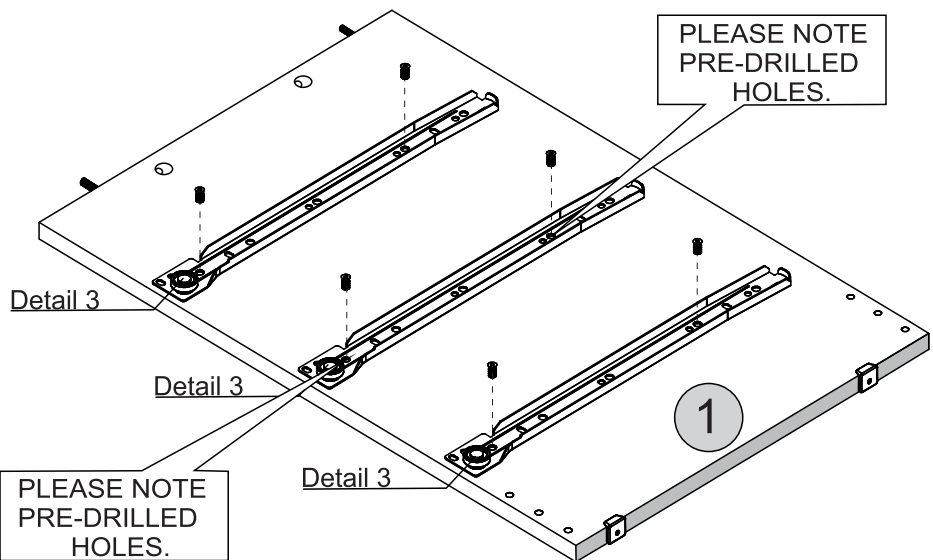
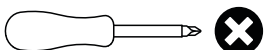

STEP 5

PARTS REQUIRED

3 - BACK BASEBOARD x1

4 - FRONT BASEBOARD x1

HARDWARE REQUIRED

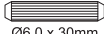
E  08
Ø6.0 x 30mm

K  01

TOOLS REQUIRED



E+K

Detail 1

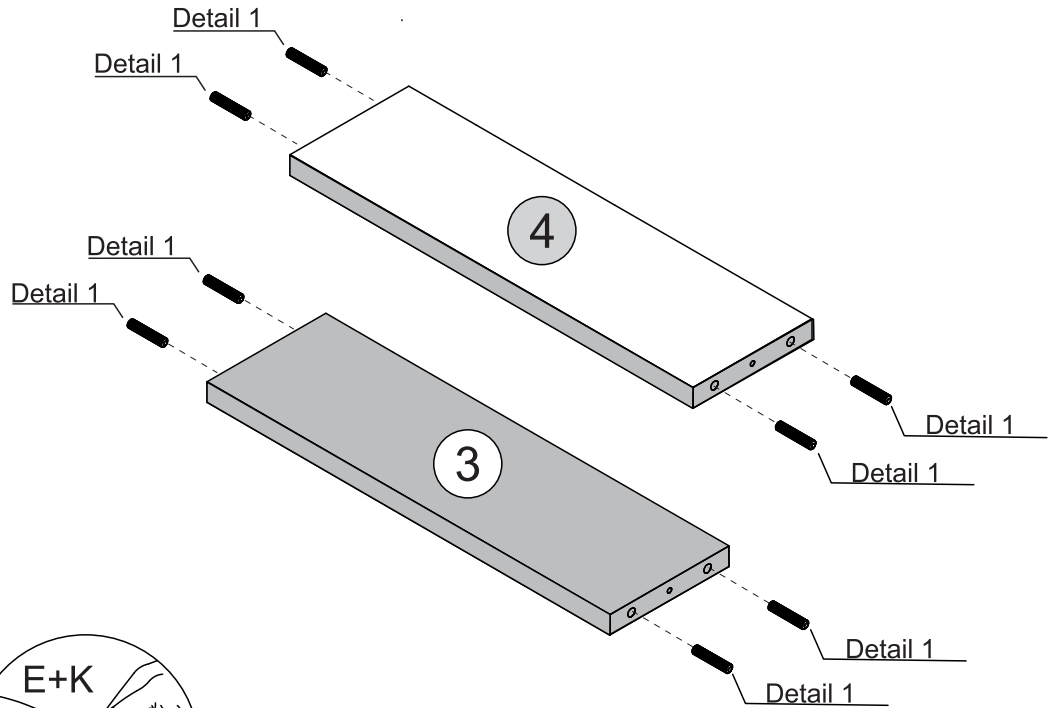

STEP 6

PARTS REQUIRED

2 - RIGHT SIDE PANEL x1

3 - BACK BASEBOARD x1

4 - FRONT BASEBOARD x1

HARDWARE REQUIRED

D  02
Ø4.0 x 45mm

K  01

TOOLS REQUIRED

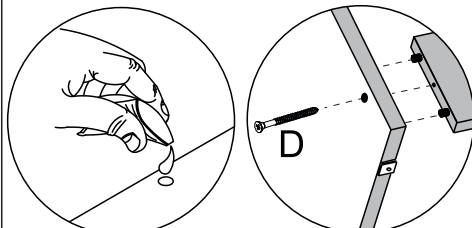
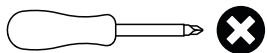

Detail 1

Detail 6

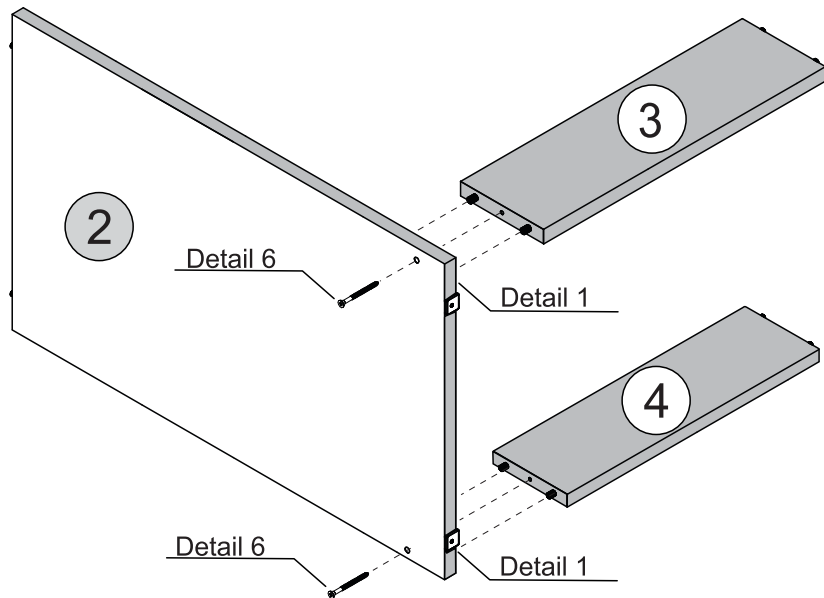

STEP 7

PARTS REQUIRED

1 - LEFT SIDE PANEL x1

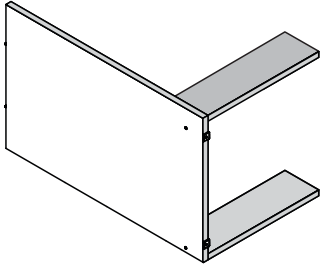

HARDWARE REQUIRED

D  Ø4,0 x 45mm 02

K  GLUE 01

TOOLS REQUIRED

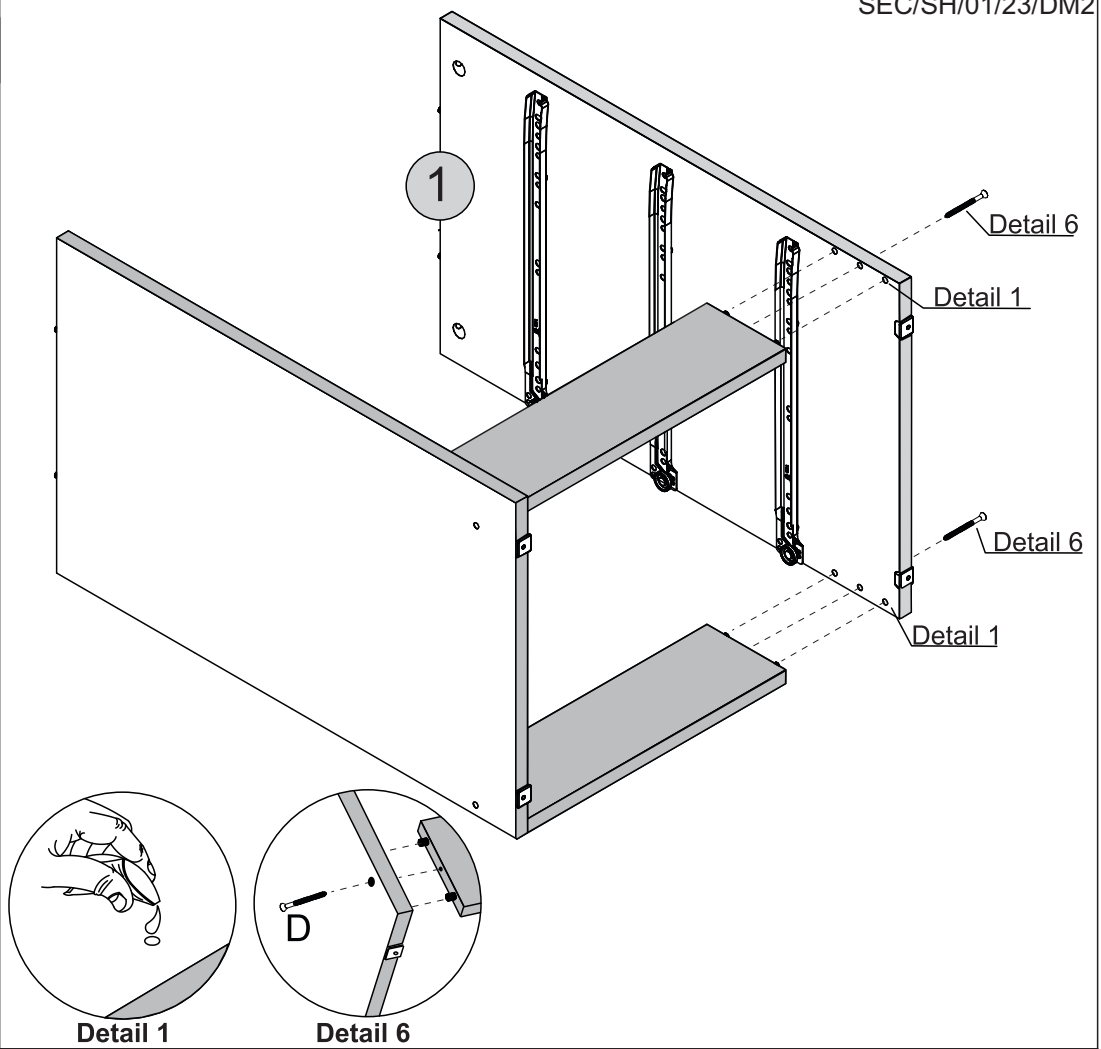
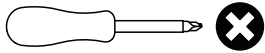

Detail 1

Detail 6

STEP 8

PARTS REQUIRED

5 - TOP PANEL x1

HARDWARE REQUIRED

G  04

TOOLS REQUIRED

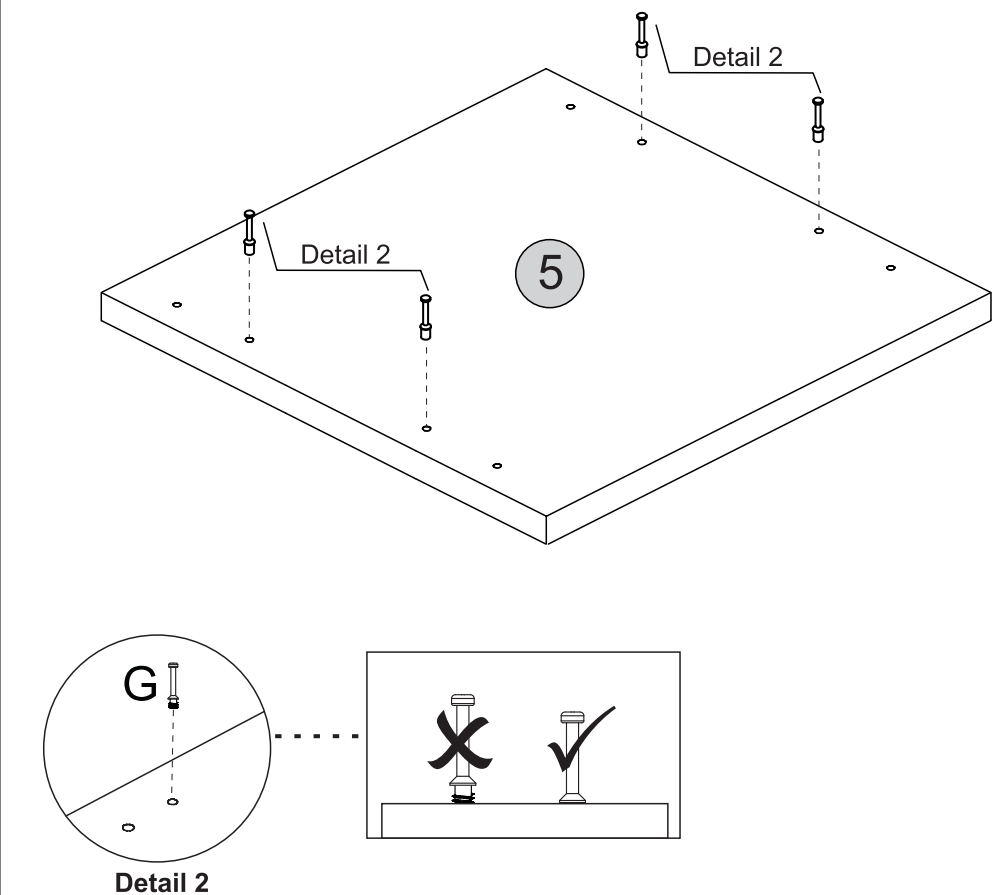
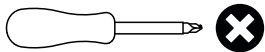

Detail 2

STEP 9

PARTS REQUIRED

5 - TOP PANEL x1

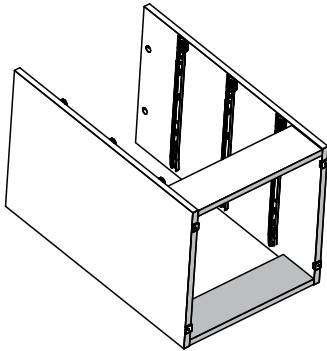

HARDWARE REQUIRED

H  04

K  01

TOOLS REQUIRED

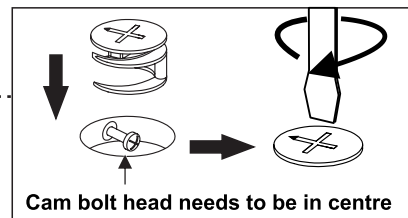
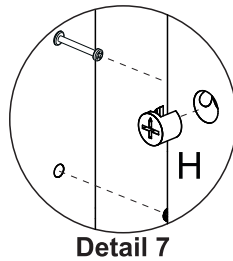
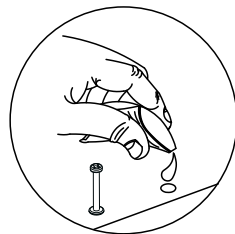
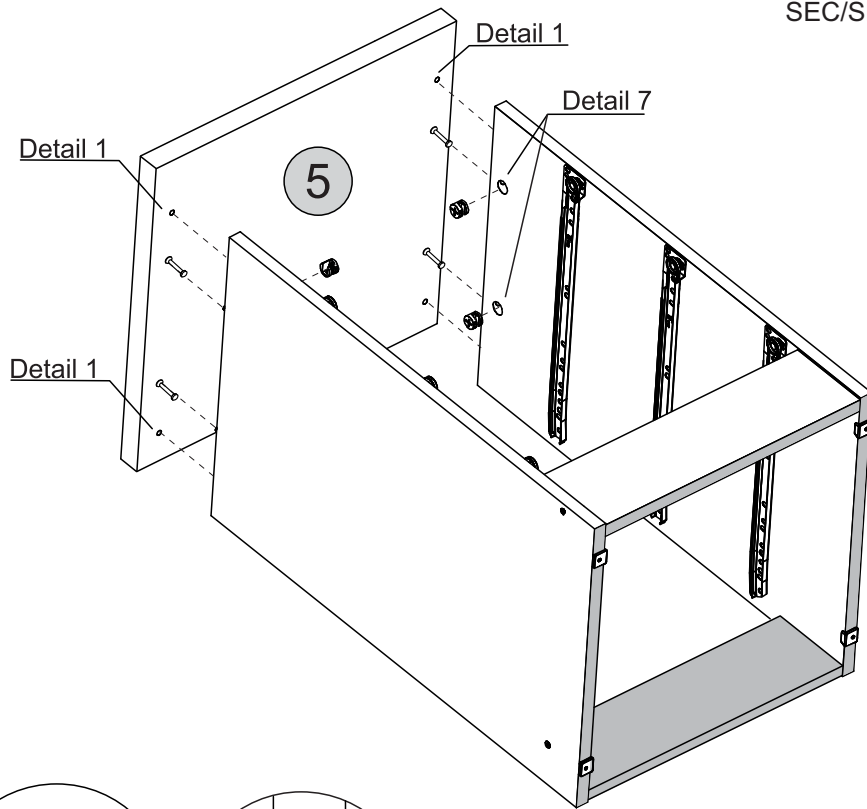
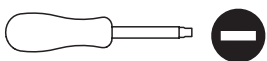

STEP 10

PARTS REQUIRED

6 - BACK PANEL x1

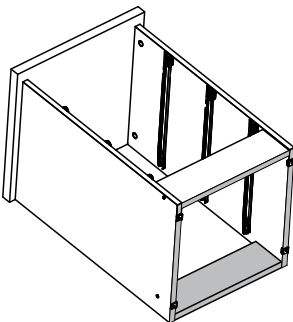

HARDWARE REQUIRED

F  12
10 x 10

N  02
Ø3,5 x 12mm

TOOLS REQUIRED

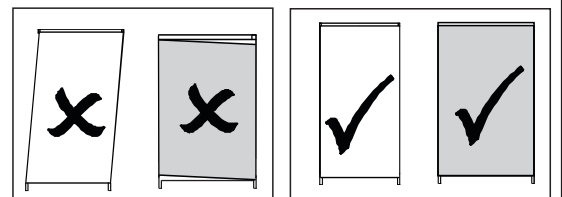
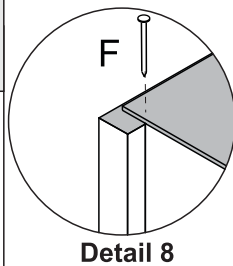
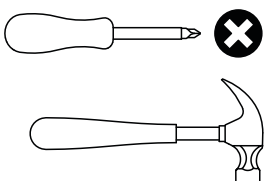

* For your future reference
Order Number should be here

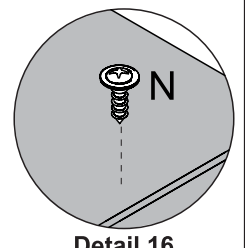
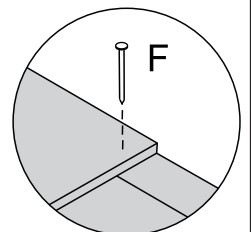
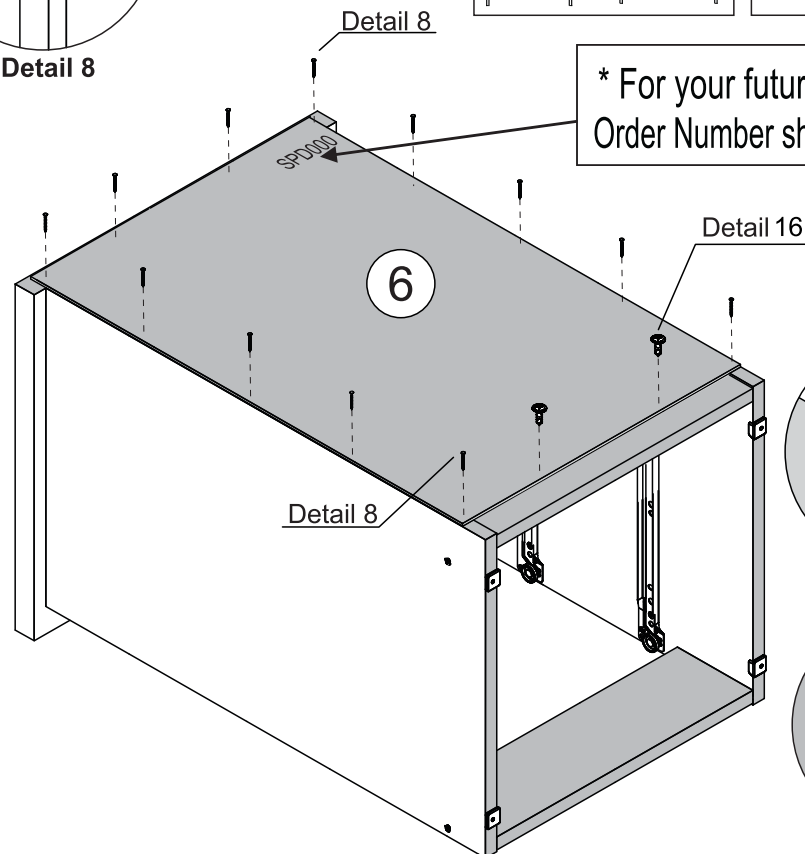

STEP 11

PARTS REQUIRED

16 - DRAWER SIDE x6

17 - DRAWER BACK PANEL x3

18 - DRAWER FRONT x3

HARDWARE REQUIRED

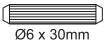
E  24
Ø6 x 30mm

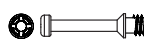
G  06

K  01

TOOLS REQUIRED

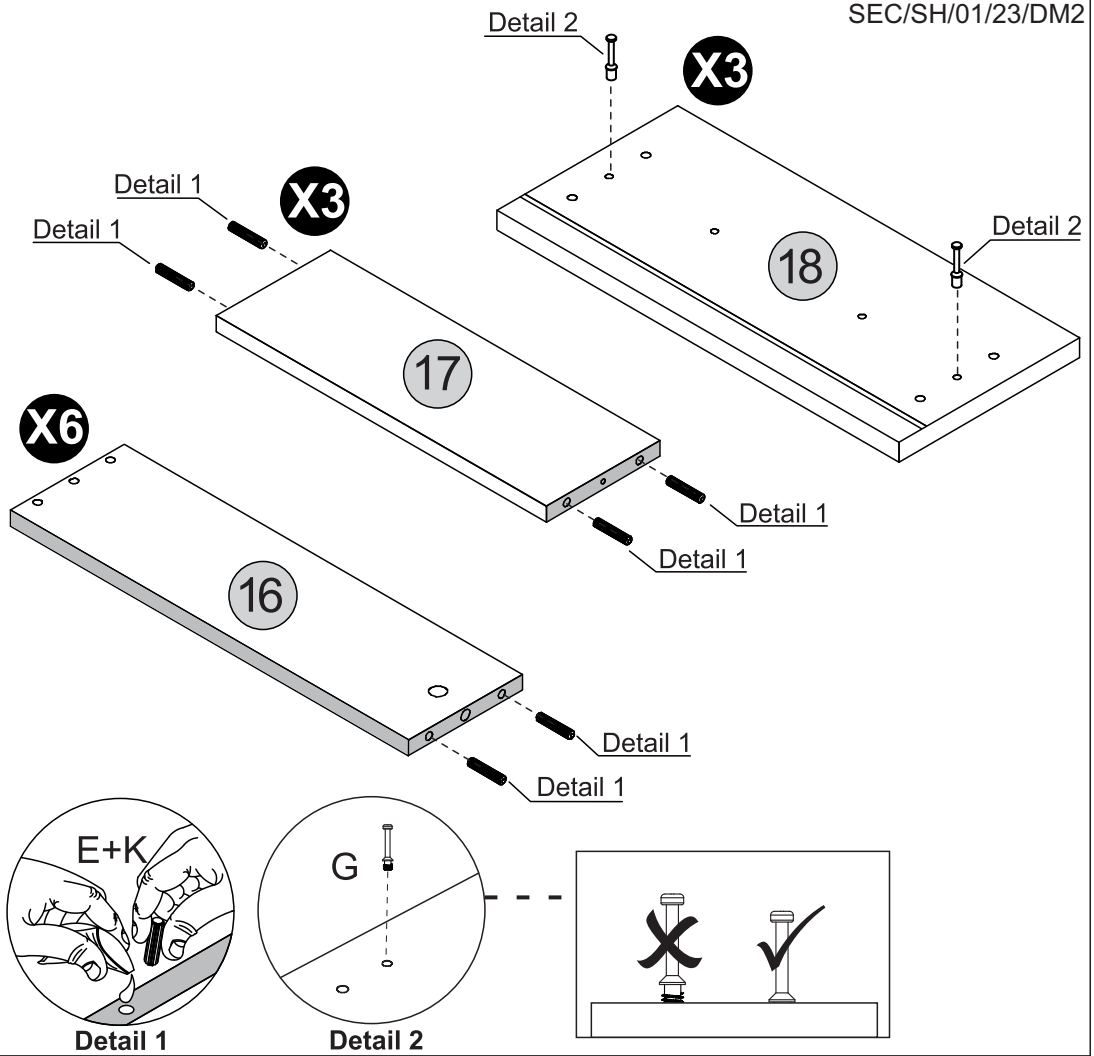
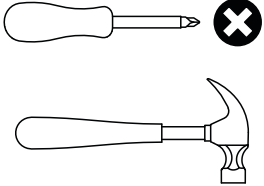

STEP 12

PARTS REQUIRED

16 - DRAWER SIDE x6

17 - DRAWER BACK PANEL x3

HARDWARE REQUIRED

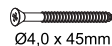
D  06
Ø4,0 x 45mm

TOOLS REQUIRED

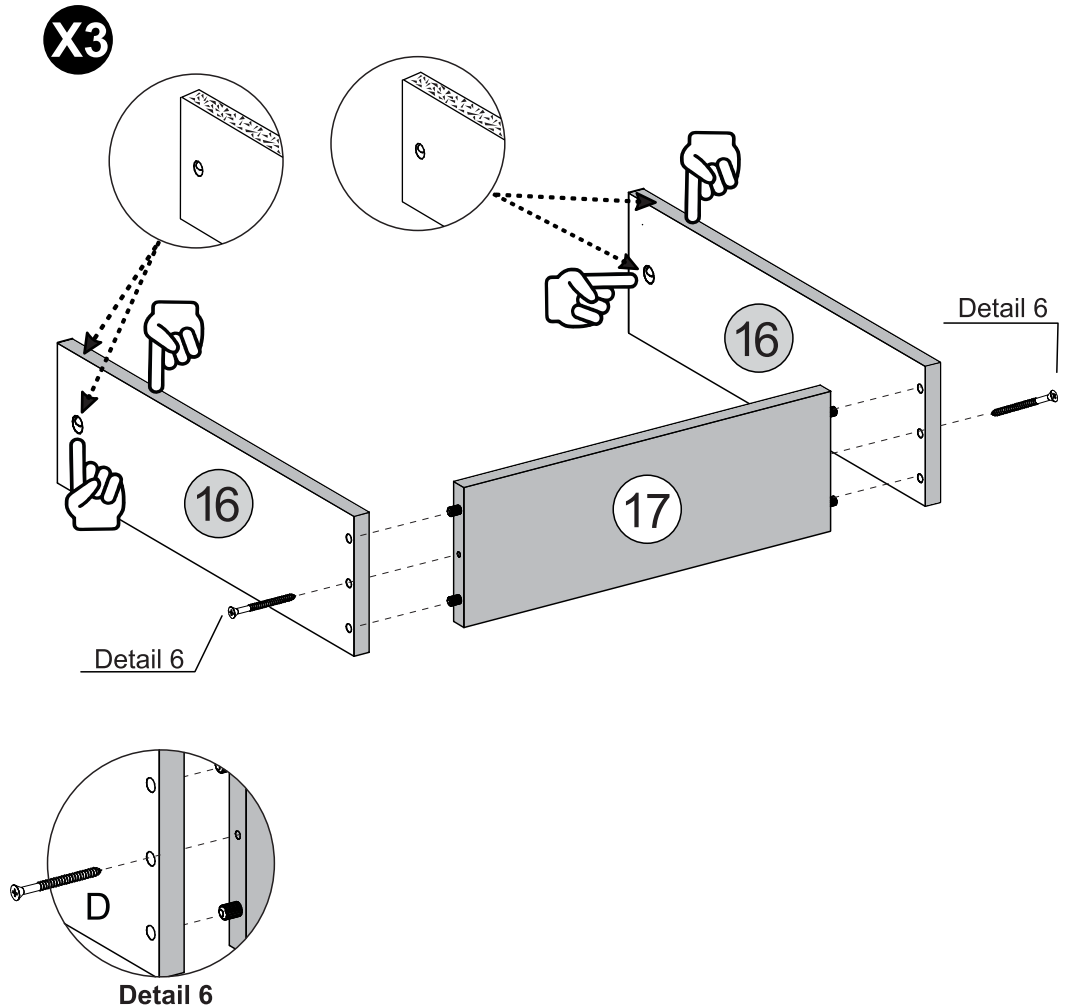
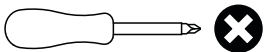

STEP 13

PARTS REQUIRED

18 - DRAWER FRONT x3

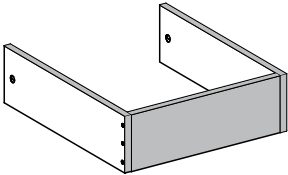

HARDWARE REQUIRED

K  01

TOOLS REQUIRED

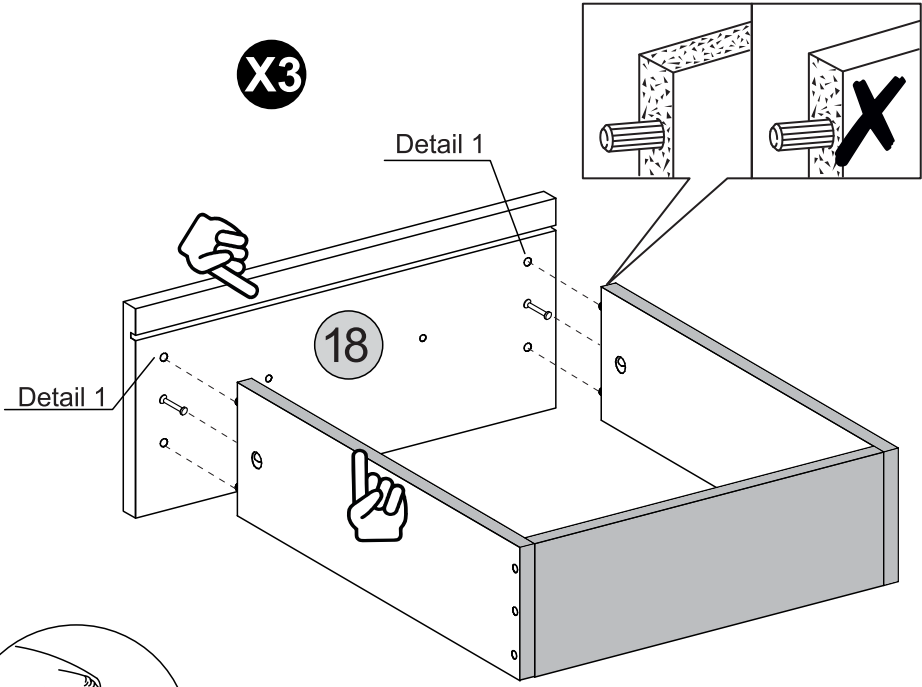
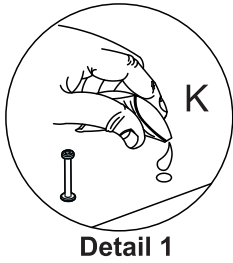

STEP 14

PARTS REQUIRED

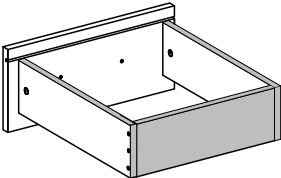

HARDWARE REQUIRED

H  06

J  12

TOOLS REQUIRED

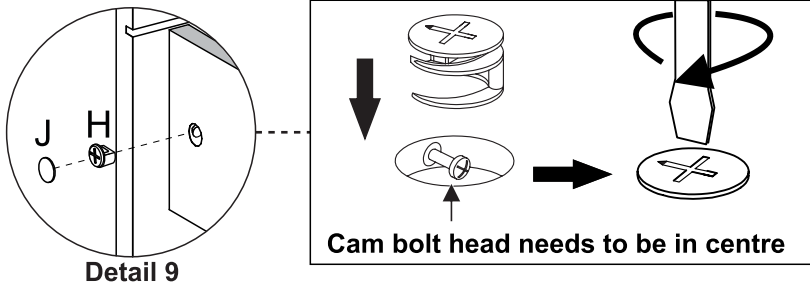
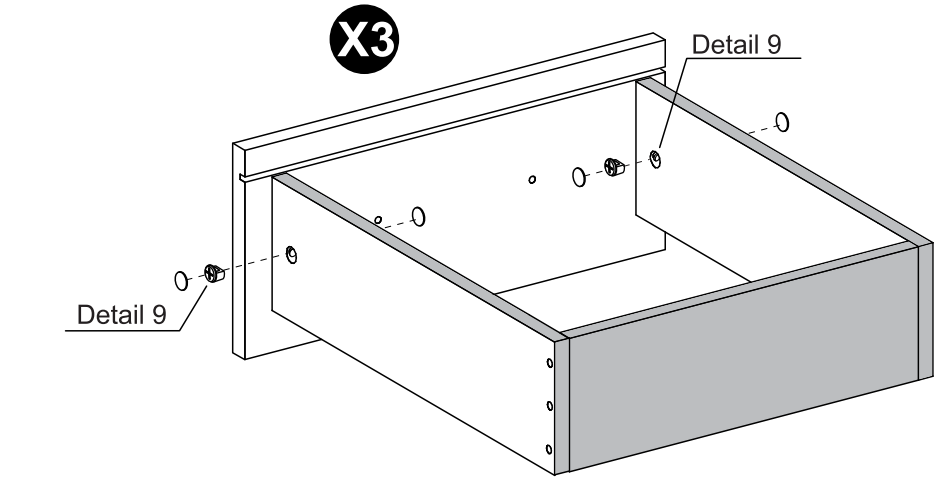
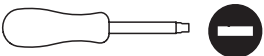

STEP 15

PARTS REQUIRED

19 - DRAWER BOTTOM x3

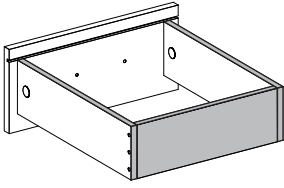

HARDWARE REQUIRED

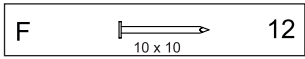

TOOLS REQUIRED

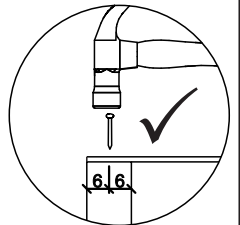
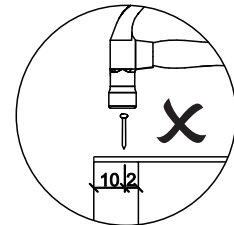
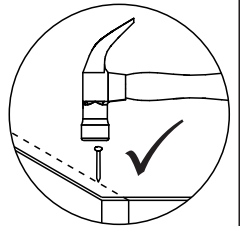
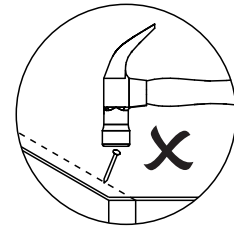
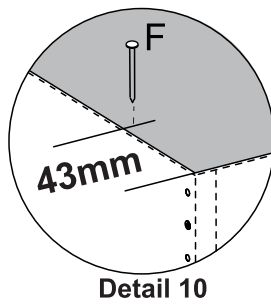
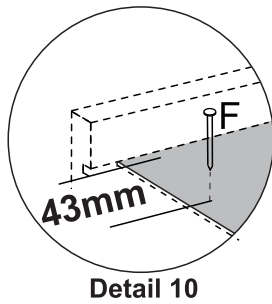
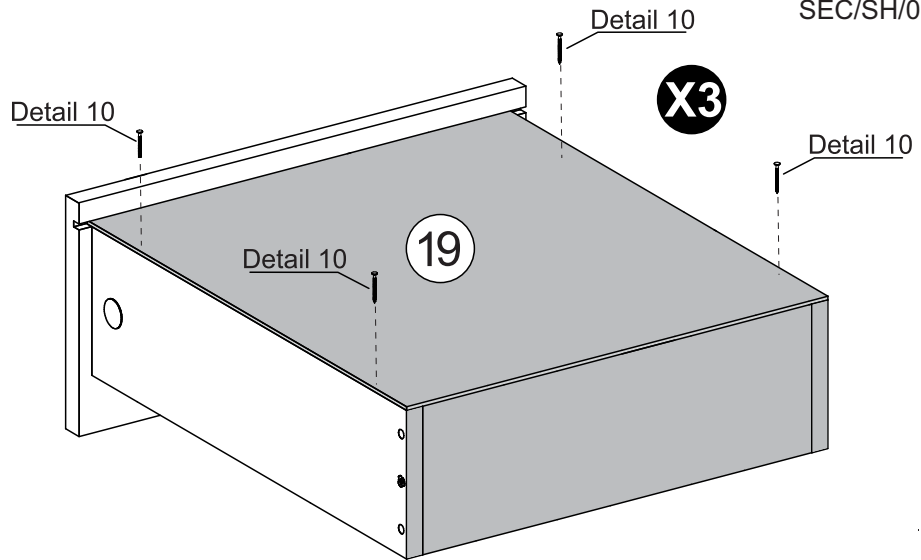
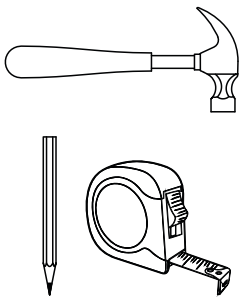

STEP 16

PARTS REQUIRED

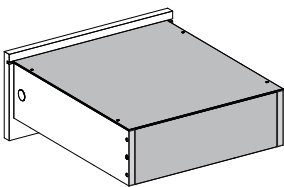

HARDWARE REQUIRED

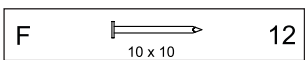

TOOLS REQUIRED

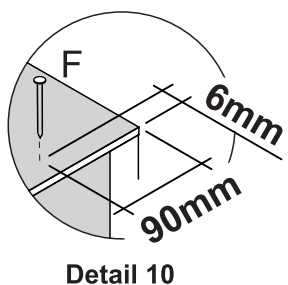
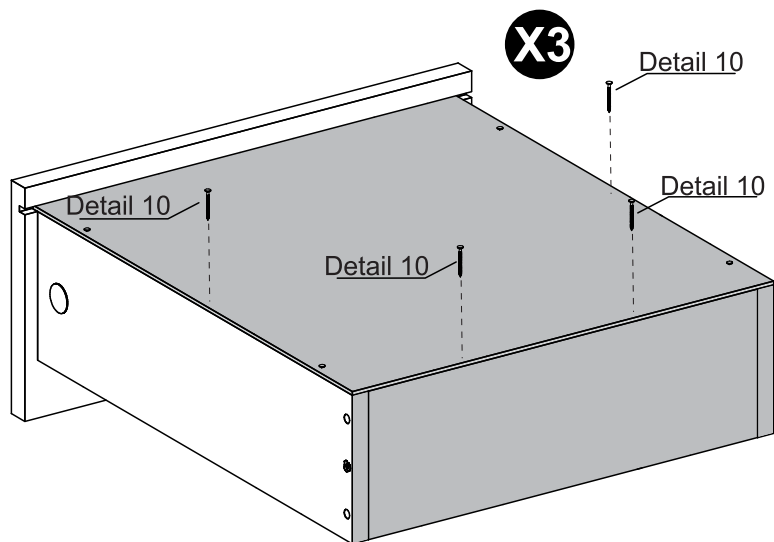
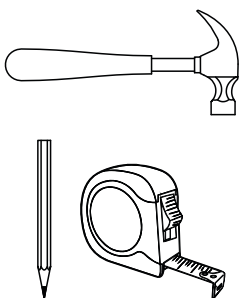

STEP 17

PARTS REQUIRED

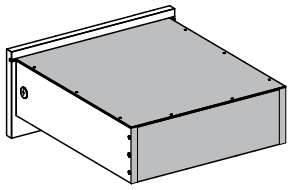

HARDWARE REQUIRED

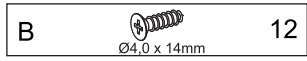

TOOLS REQUIRED

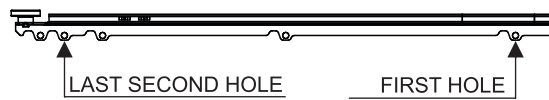
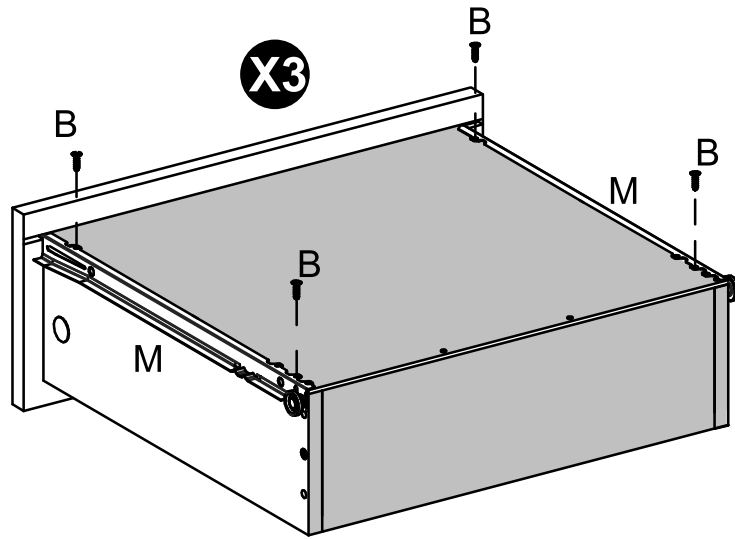
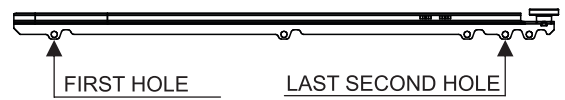
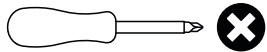

STEP 18

PARTS REQUIRED

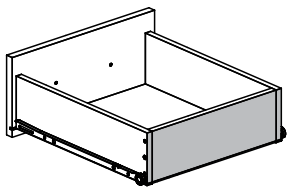

HARDWARE REQUIRED

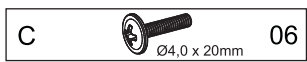

TOOLS REQUIRED

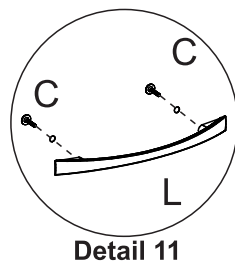
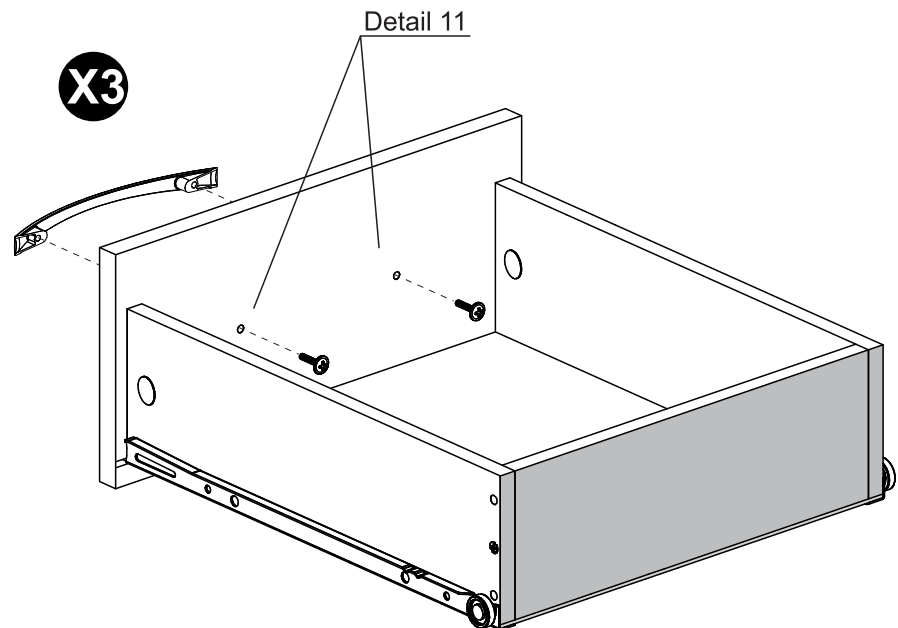
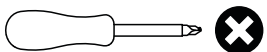

STEP 19

PARTS REQUIRED

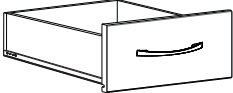
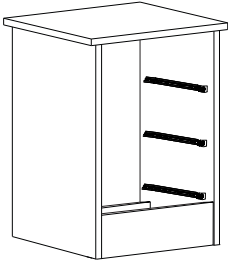

HARDWARE REQUIRED



TOOLS REQUIRED

TIP
If desired, after assembly use an alcohol cleaner to erase the number printed on the parts.

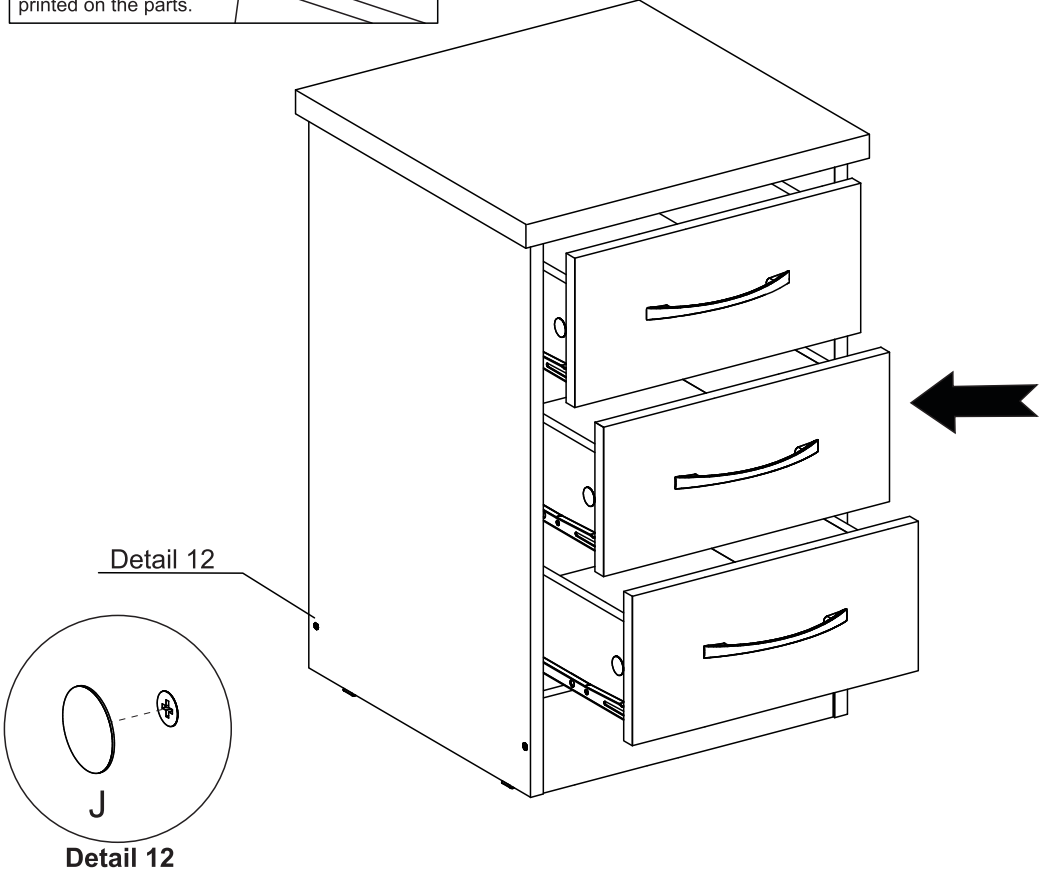

STEP 20

PARTS REQUIRED

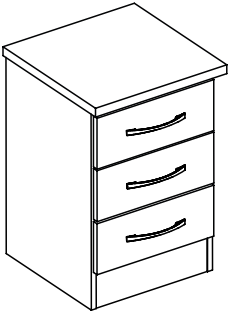

HARDWARE REQUIRED

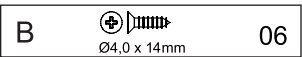

TOOLS REQUIRED

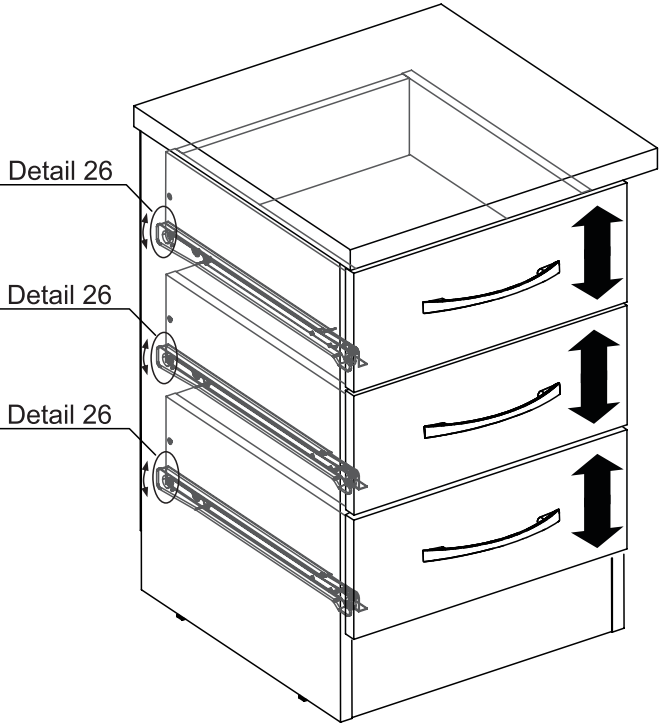
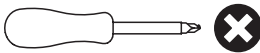

Drawer Adjustment

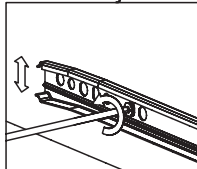

Drawer Lock

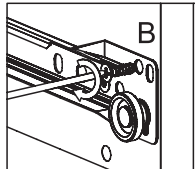

Detail 26