

MALVERN 5 DRAWER NARROW CHEST ASSEMBLY INSTRUCTIONS

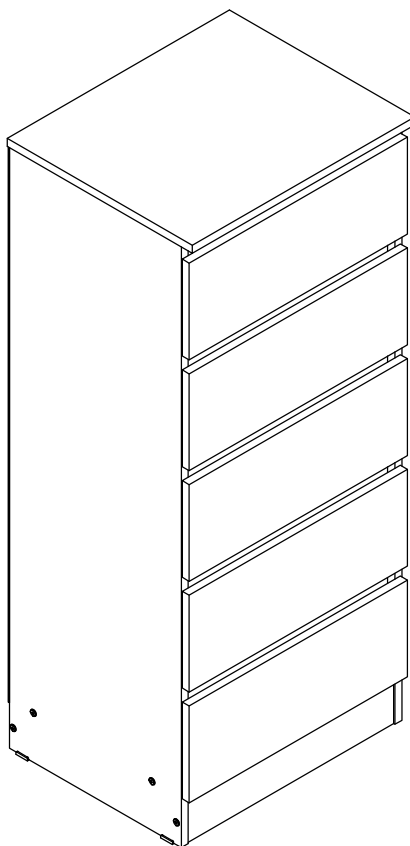
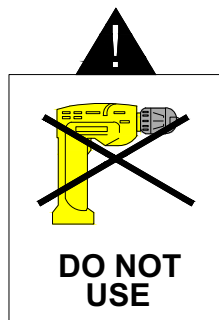

IMPORTANT FOR DOMESTIC USE ONLY PLEASE READ BEFORE YOU CONTINUE FURTHER

THE PRODUCT YOU HAVE PURCHASED WILL GIVE YOU MANY YEARS OF SERVICE IF YOU FOLLOW THE GUIDELINES FOR ITS SAFE ASSEMBLY AND PERIODIC MAINTENANCE AND CLEANING.

ASSEMBLE ON A SOFT CLEAN SURFACE.

DO NOT USE ANY TOOLS OTHER THAN THOSE SHOWN.

ANY SPANNERS OR ALLEN KEYS REQUIRED ARE INCLUDED WITH THE FITTINGS KIT.

DO NOT FOR ANY REASON USE A POWER TOOL TO ASSEMBLE THIS PRODUCT. ITS USE WILL INVALIDATE ANY CLAIM YOU MAY HAVE AND COULD MAKE THIS PRODUCT UNSAFE.

DEPENDING ON THE AMOUNT OF USE THIS PRODUCT RECEIVES IT MAY BE NECESSARY TO TIGHTEN UP THE FIXINGS FROM TIME TO TIME. THIS IS COMPLETELY NORMAL FOR ANY FLAT PACK FURNITURE. DO NOT OVERTIGHTEN FIXING.

FOR CLEANING, YOU MAY USE A DAMP CLOTH (NOT WET) DO NOT USE POLISH, DETERGENT OR CHEMICAL CLEANERS.



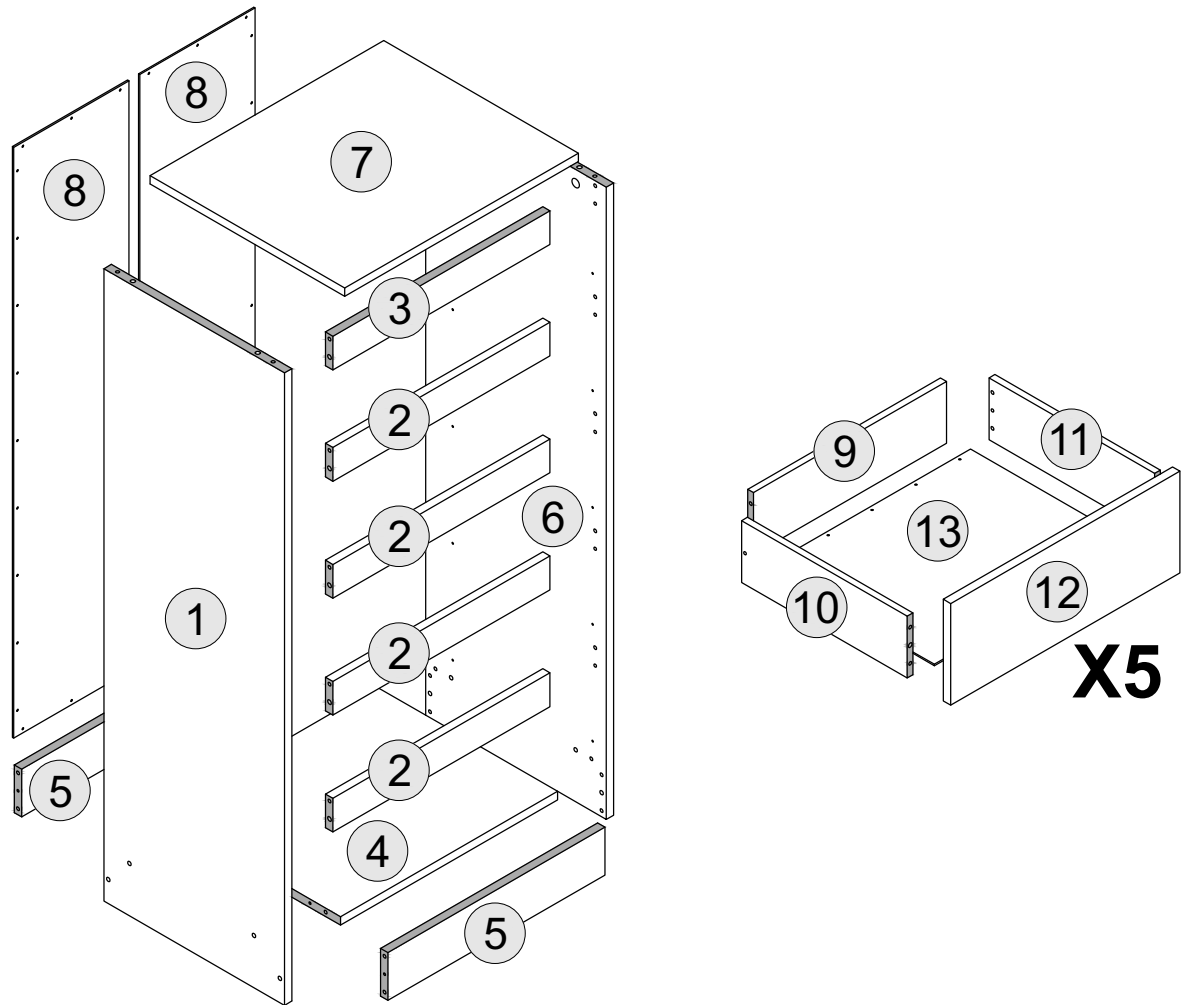









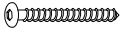

THE SURFACE OF THIS ITEM IS NOT HEAT RESISTANT. ALWAYS USE A PLACE MAT UNDER HOT OR COLD ITEMS TO PREVENT MARKING.

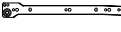

PART LIST

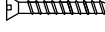
Part Number	Part Code	Part Description	Quantity	Carton
1	S100-102-192-EU1-01	Side Panel - Left	1	1/1
2	S100-102-192-EU1-02	Crossbar	4	1/1
3	S100-102-192-EU1-03	Top Crossbar	1	1/1
4	S100-102-192-EU1-04	Bottom Panel	1	1/1
5	S100-102-192-EU1-05	Base Apron	2	1/1
6	S100-102-192-EU1-06	Side Panel - Right	1	1/1
7	S100-102-192-EU1-07	Top Panel	1	1/1
8	S100-102-192-EU1-08	Back Panel	2	1/1
9	S100-102-192-EU1-09	Drawer Back	5	1/1
10	S100-102-192-EU1-10	Drawer Side - Left	5	1/1
11	S100-102-192-EU1-11	Drawer Side - Right	5	1/1
12	S100-102-192-EU1-12	Drawer Front	5	1/1
13	S100-102-192-EU1-13	Drawer Base	5	1/1

HARDWARE LIST

A		DOWEL 6 X 30MM	66 PCS
B		ALLEN KEY	1 PC
C		BOLT M6 X 50MM	8 PCS
D		SCREW M3.5 X 16MM	34 PCS
E		TACK	30 PCS
F		PLASTIC FOOT	4 PCS
G		SCREW M3.5 X 12MM	65 PCS
H		CAM BOLT + CAM NUT	24 SETS
I		DRAWER RUNNER A - L/R	10 PCS
J		DRAWER RUNNER B - L/R	10 PCS
K		SCREW M4 X 38MM	10 PCS
L		PLASTIC H STRIP	1 PC
M		ANTI - TIP STRAP	2 PCS
N		SCREW M4 X 16MM	2 PCS

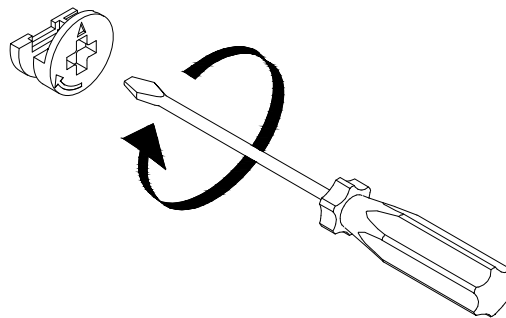

(SCREWDRIVER NOT PROVIDED)

USE A FLAT HEAD SCREWDRIVER TO TIGHTEN THE CAM NUTS. A QUARTER TURN CLOCKWISE IS ALL THAT IS NEEDED.

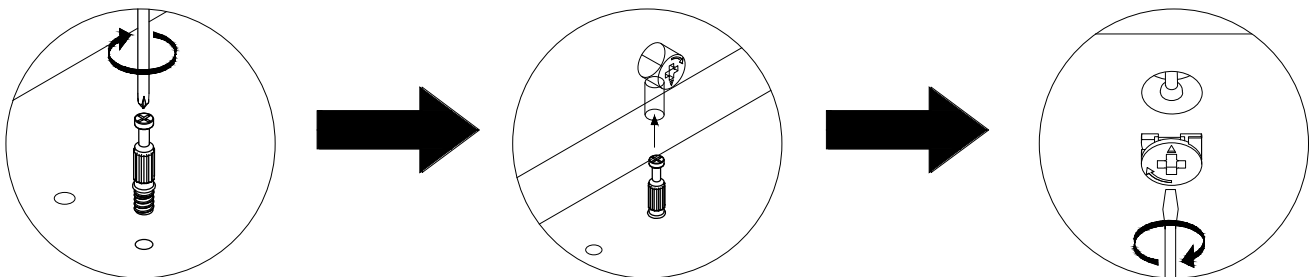

STEP 1 - USE A CROSS SLOT SCREWDRIVER TO TIGHTEN THE CAM BOLT INTO THE HOLE.

STEP 2 - ALIGN THE CAM BOLT WITH THE HOLE AND PUSH TOGETHER UNTIL FLUSH. (MAKE SURE THE ARROW OF THE CAM LOCK IS POINTING TOWARD ON THE EDGE OF THE PANEL.)

STEP 3 - THE HEAD OF THE BOLT GOES INTO THE WIDE MOUTH OF THE CAM LOCK. YOU THEN TURN THE LOCK SO THE NARROW PART CLOSES OVER THE BOLT.

STEP 1

PARTS REQUIRED

1 - SIDE PANEL - LEFT x1

HARDWARE REQUIRED

A  02

H  05

H  02

G  20

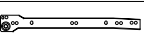
I  05

TOOLS REQUIRED

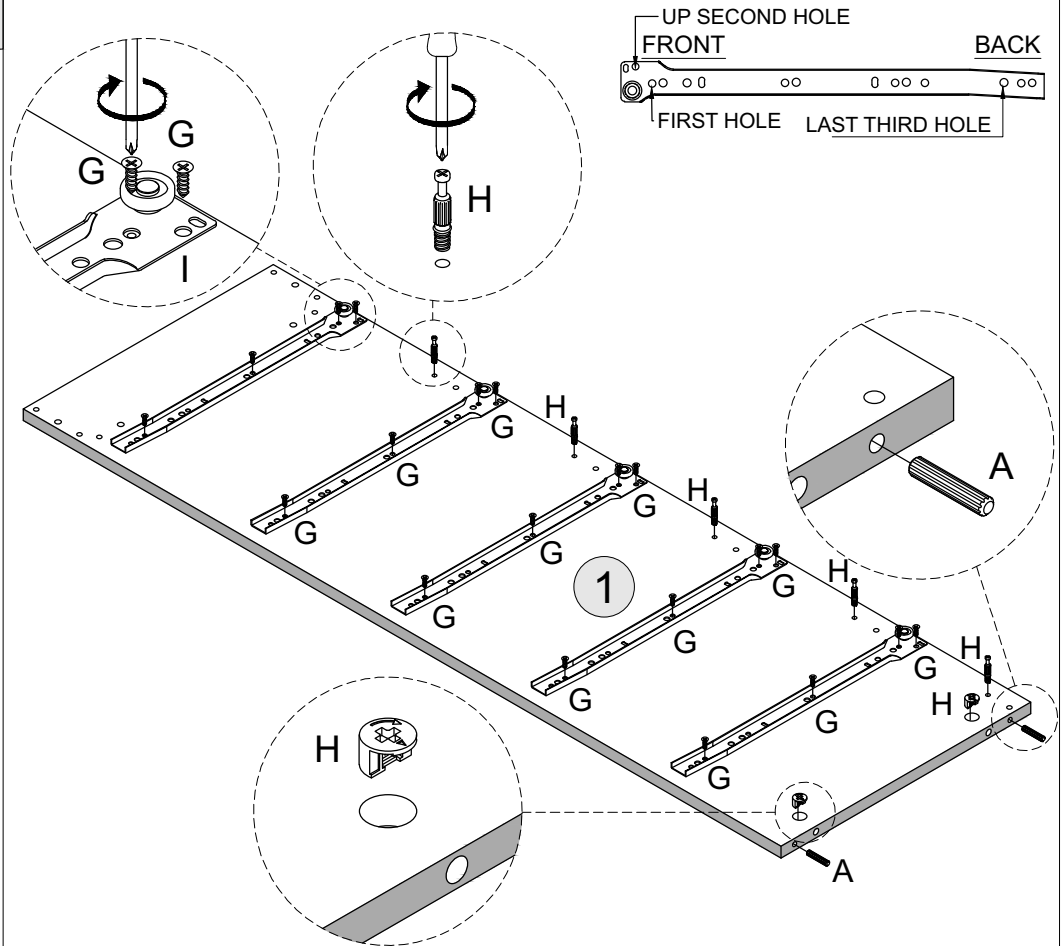
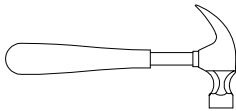
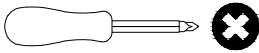

STEP 2

PARTS REQUIRED

6 - SIDE PANEL - RIGHT x1

HARDWARE REQUIRED

A  02

H  05

H  02

G  20

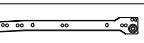
I  05

TOOLS REQUIRED

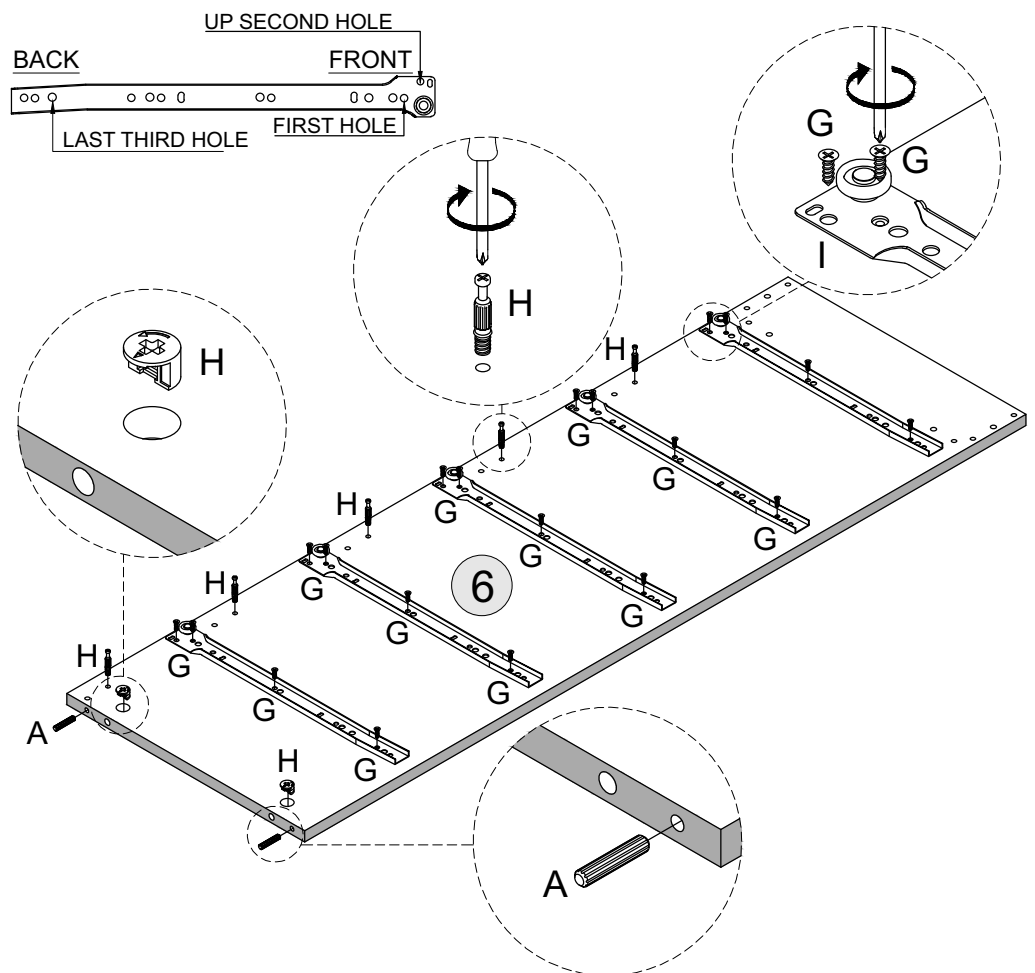
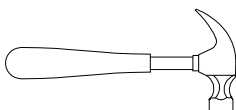
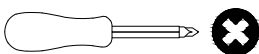

STEP 3

PARTS REQUIRED

4 - BOTTOM PANEL	x1
5 - BASE APRON	x2

HARDWARE REQUIRED

A		12
---	---	----

TOOLS REQUIRED

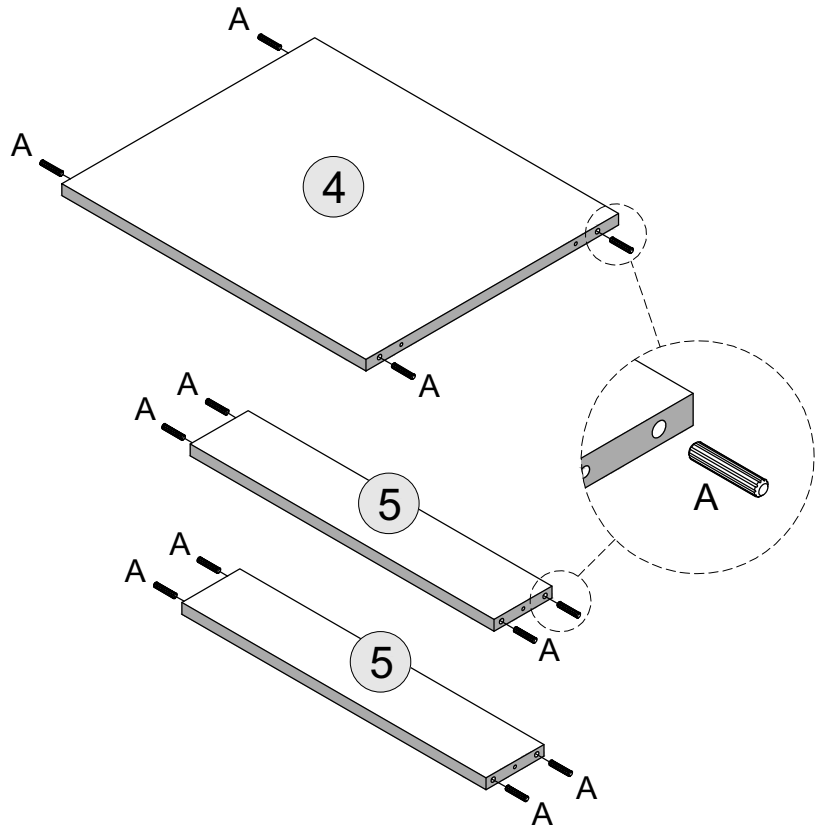
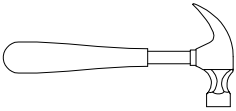



STEP 4

PARTS REQUIRED

2 - CROSSBAR	x4
3 - TOP CROSSBAR	x1
7 - TOP PANEL	x1

HARDWARE REQUIRED

A		10
H		10
H		04

TOOLS REQUIRED

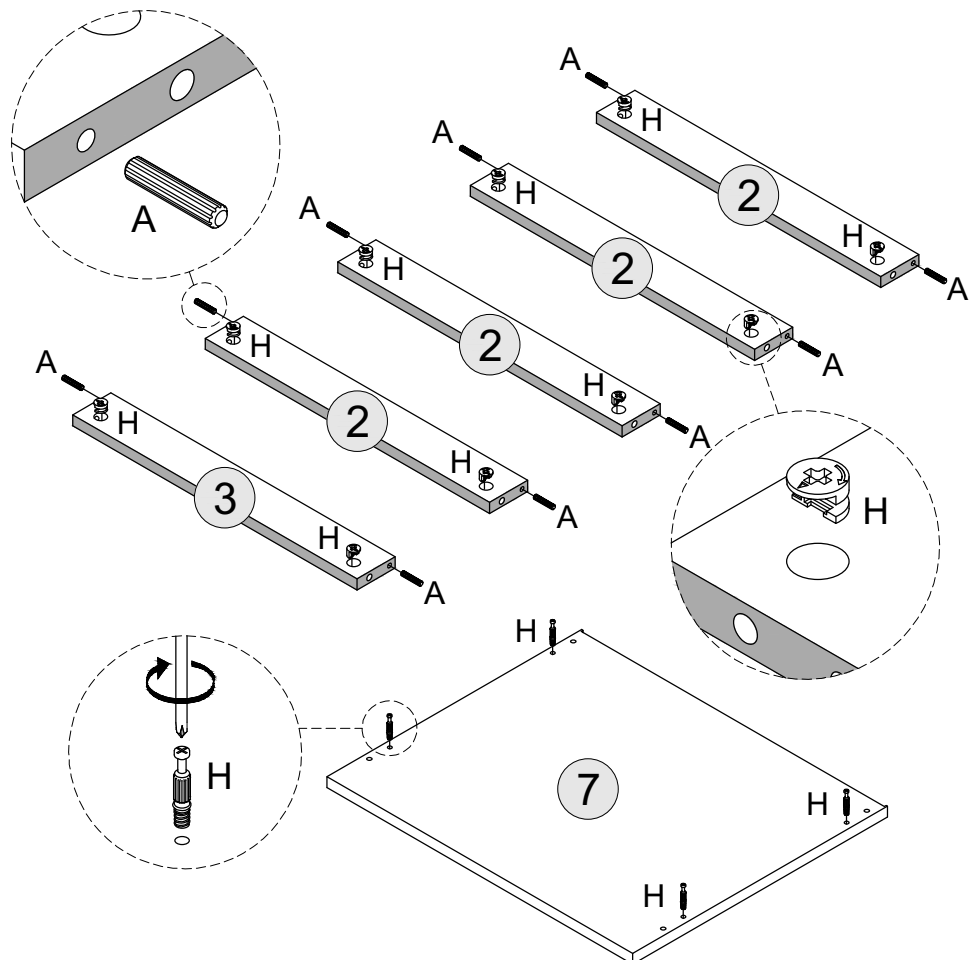
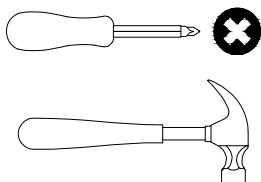

STEP 5

PARTS REQUIRED

1 - SIDE PANEL - LEFT	x1
2 - CROSSBAR	x4
3 - TOP CROSSBAR	x1
4 - BOTTOM PANEL	x1
5 - BASE APRON	x2

HARDWARE REQUIRED

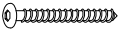
C		04
---	---	----

TOOLS REQUIRED

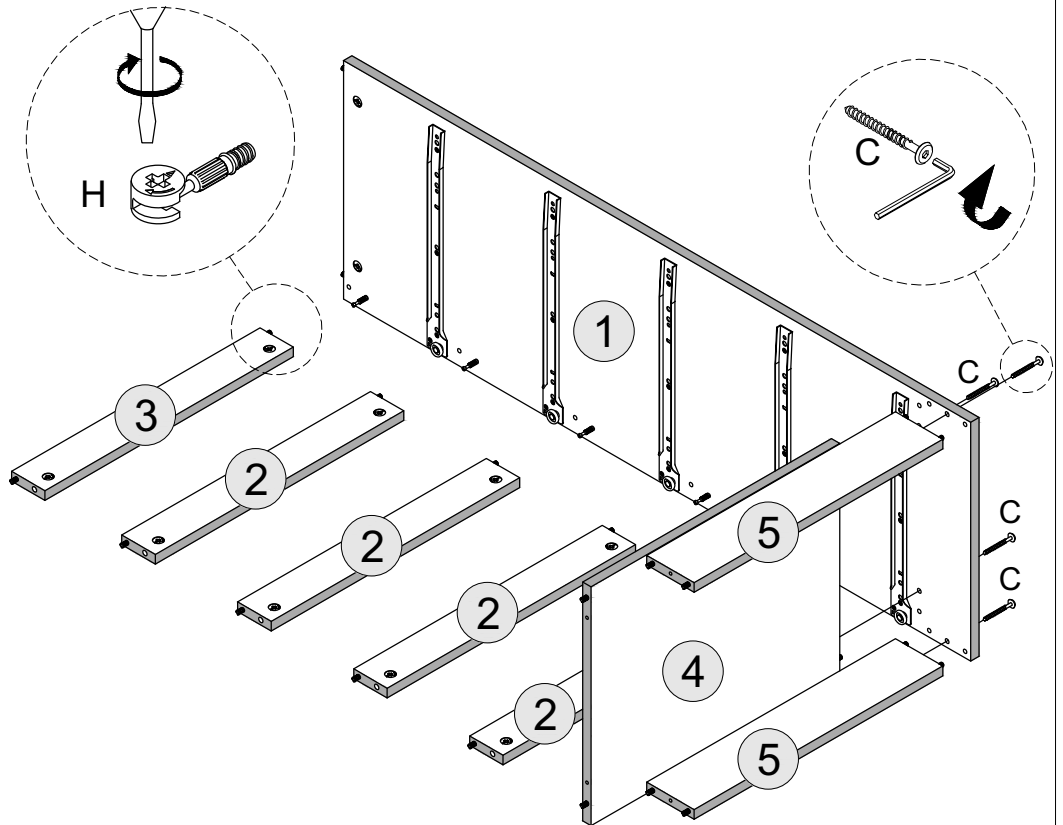
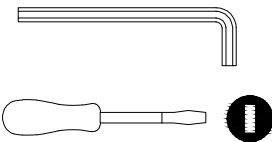

STEP 6

PARTS REQUIRED

6 - SIDE PANEL - RIGHT	x1
------------------------	----

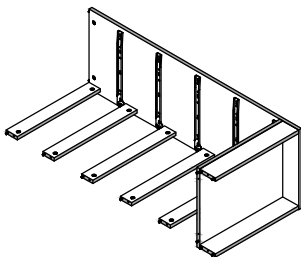

HARDWARE REQUIRED

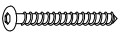
C		04
---	---	----

TOOLS REQUIRED

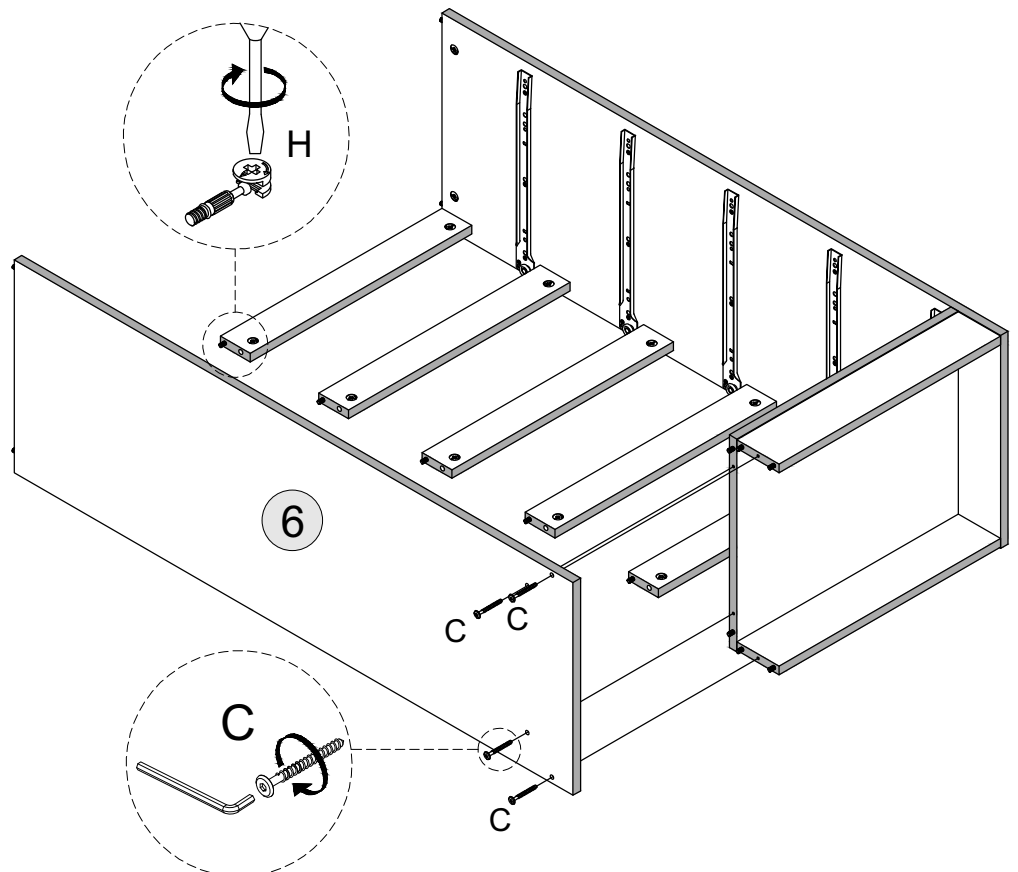
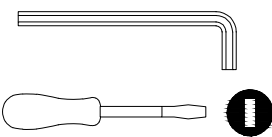

STEP 7

PARTS REQUIRED

7 - TOP PANEL x1

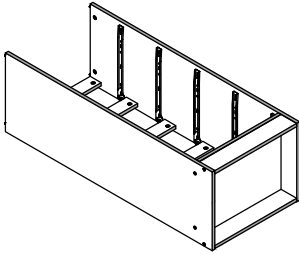

HARDWARE REQUIRED

D  04

F  04

TOOLS REQUIRED

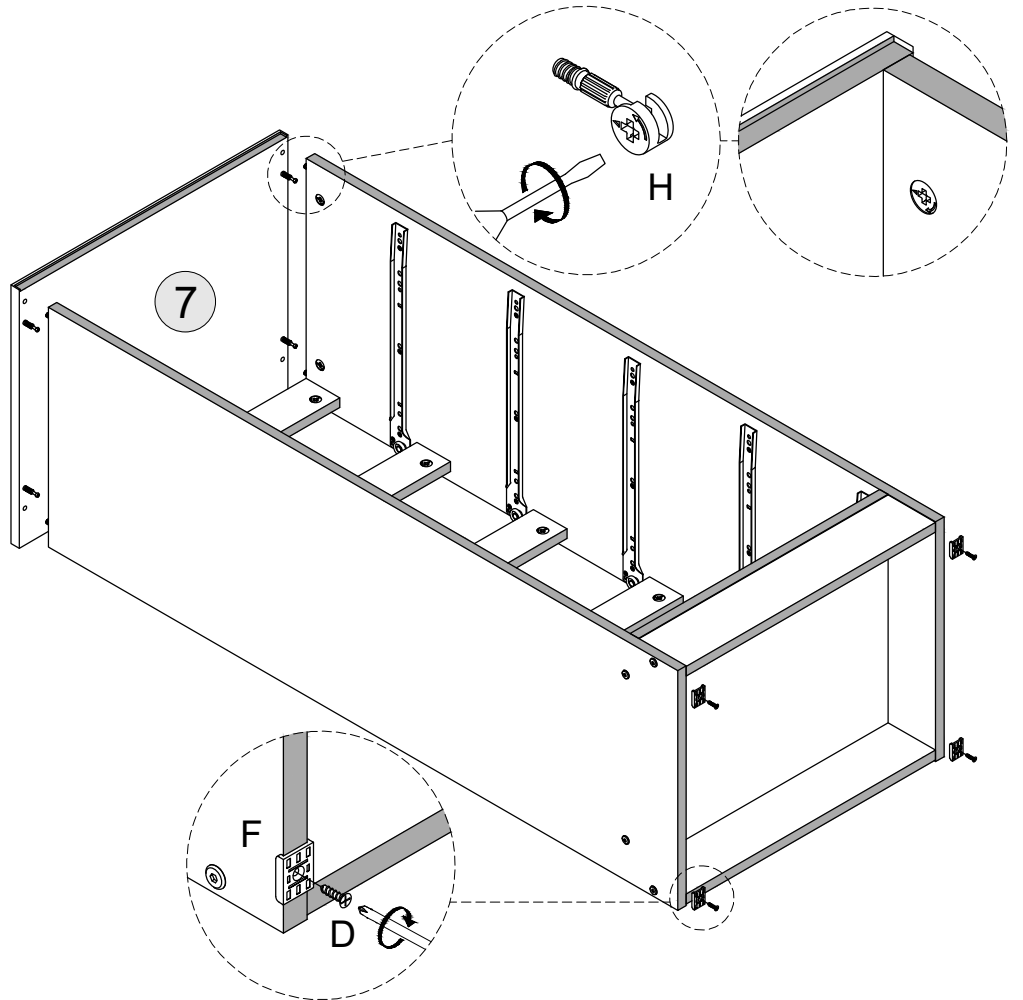
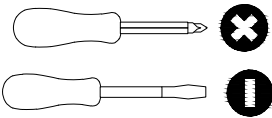

STEP 8

PARTS REQUIRED

8 - BACK PANEL x2

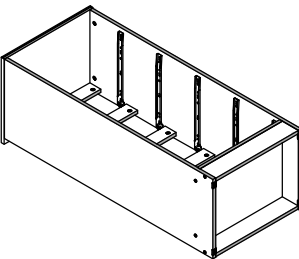

HARDWARE REQUIRED

E  30

L  01

TOOLS REQUIRED

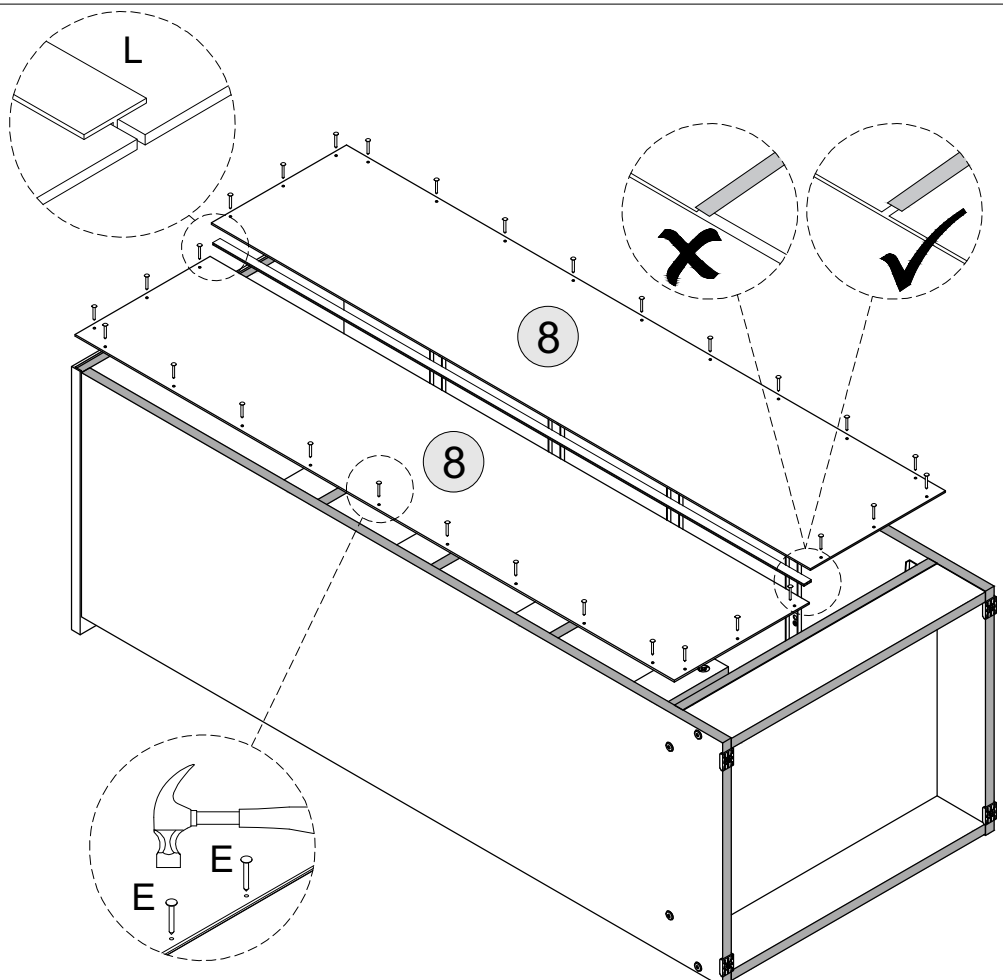
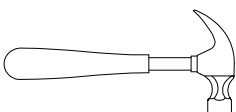



STEP 9

PARTS REQUIRED

9 - DRAWER BACK	x5
10 - DRAWER SIDE-LEFT	x5
11 - DRAWER SIDE-RIGHT	x5
12 - DRAWER FRONT	x5

HARDWARE REQUIRED

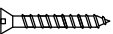
A		40
H		10
K		10

TOOLS REQUIRED

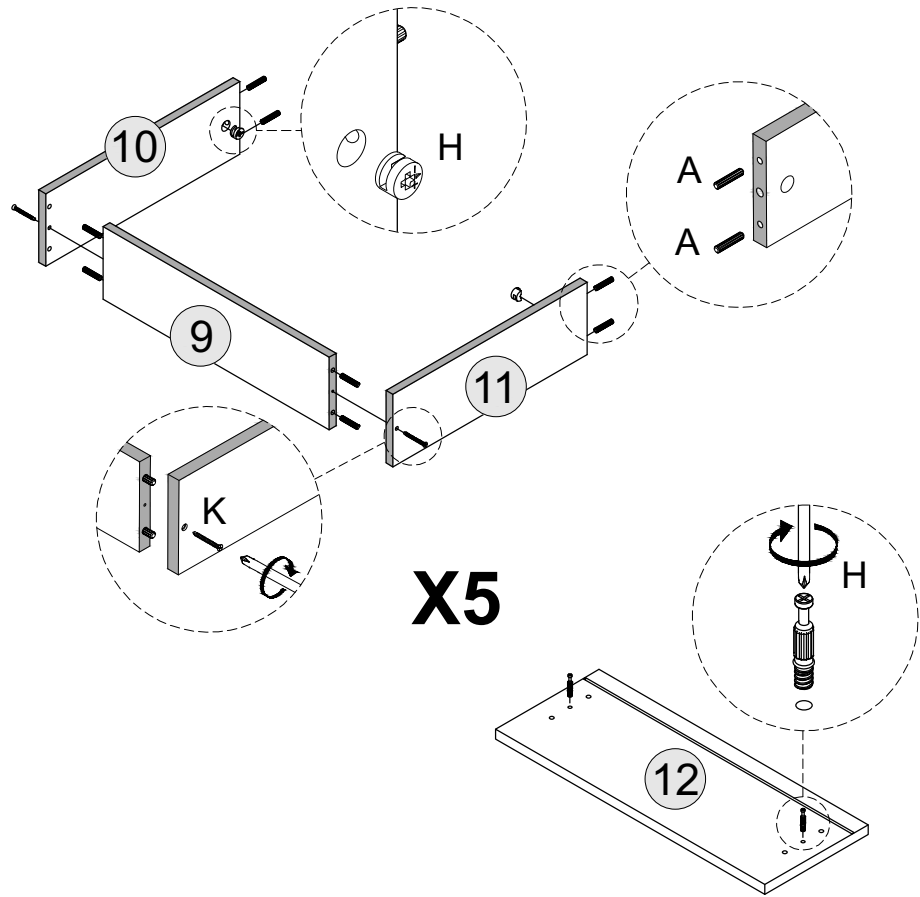
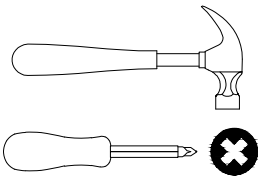

STEP 10

PARTS REQUIRED

13 - DRAWER BASE	x5
------------------	----

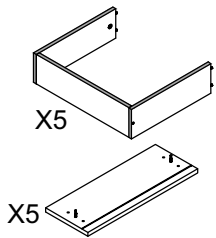

HARDWARE REQUIRED

G		25
---	---	----

TOOLS REQUIRED

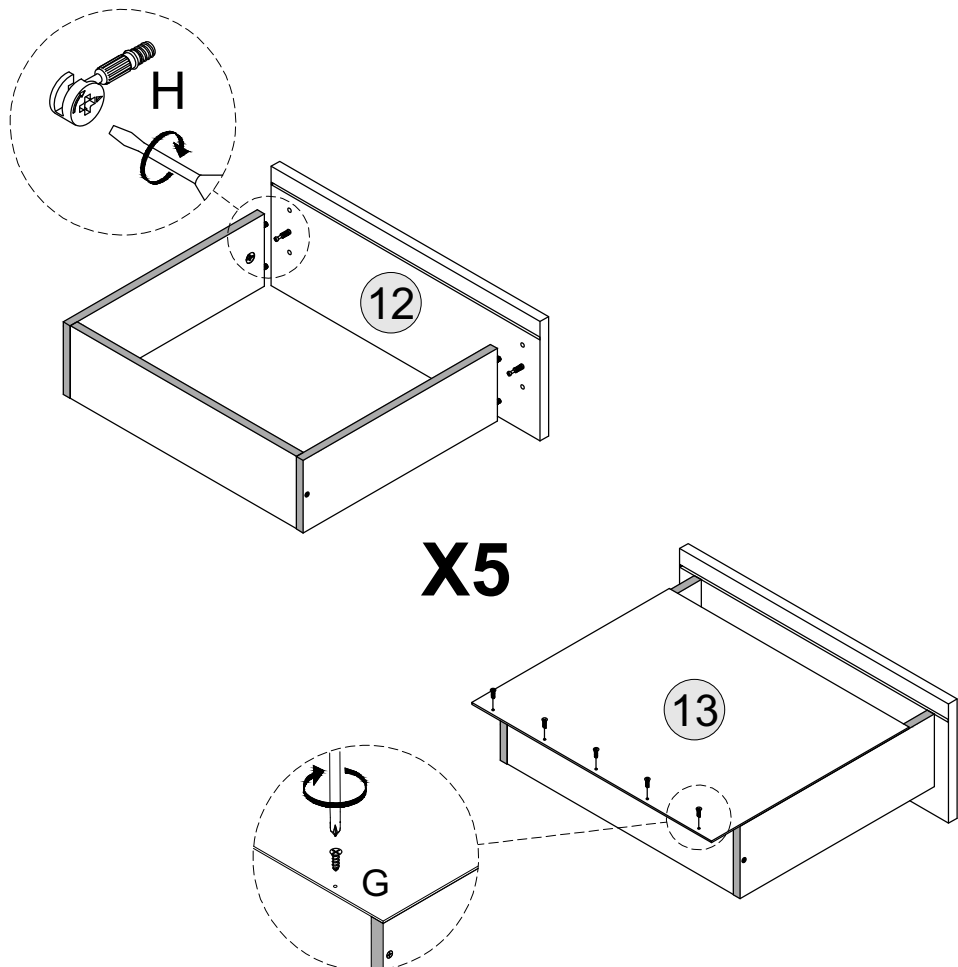
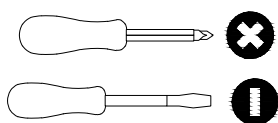

STEP 11

PARTS REQUIRED

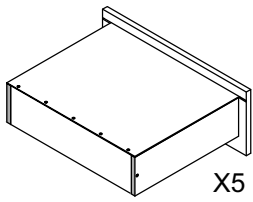

HARDWARE REQUIRED

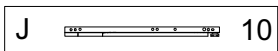
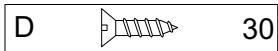

TOOLS REQUIRED

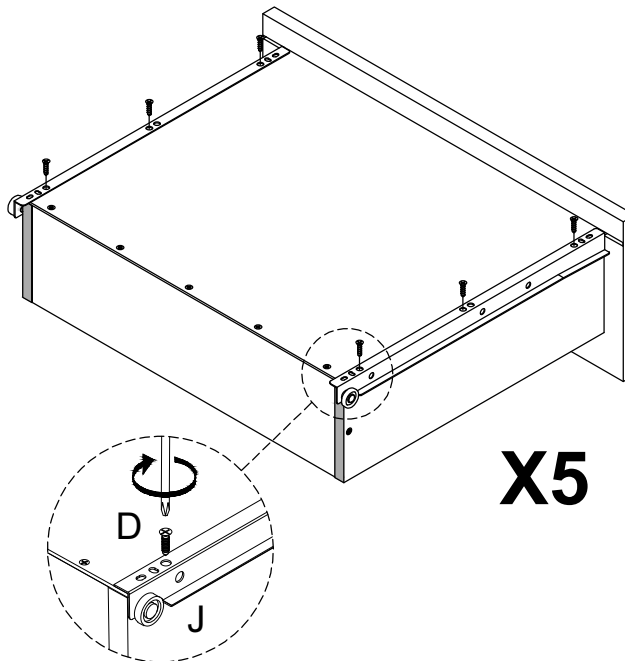
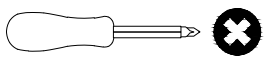

STEP 12

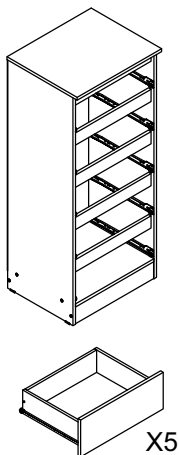

PARTS REQUIRED

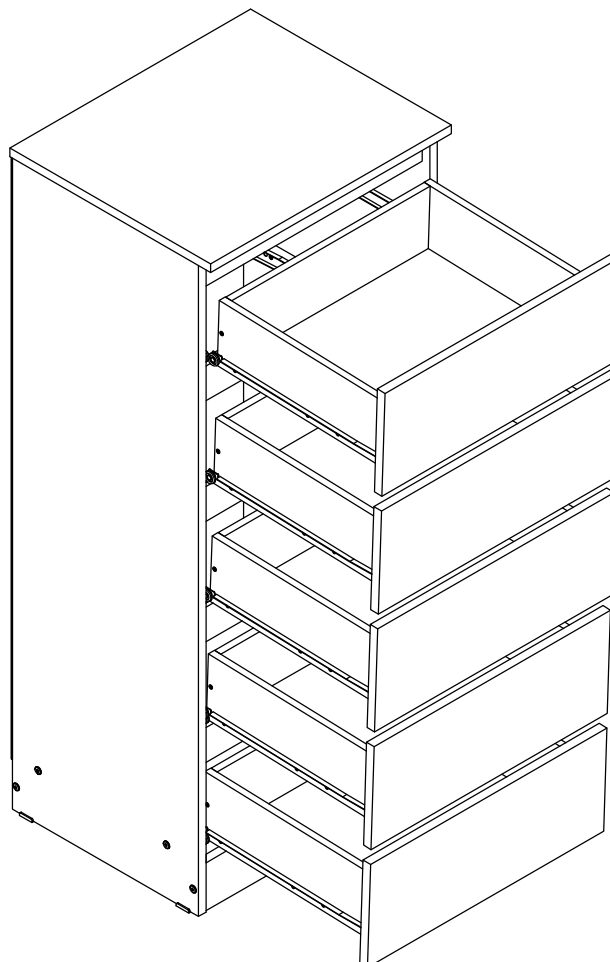

HARDWARE REQUIRED

TOOLS REQUIRED

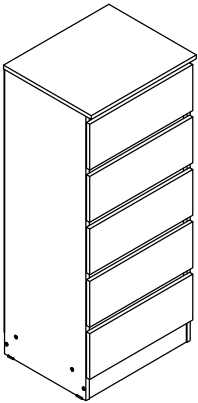

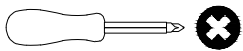
STEP 13PART REQUIREDHARDWARE REQUIREDM  02N  02TOOLS REQUIRED**WARNING**

Serious or fatal injuries can occur from furniture tipping over. To prevent the furniture from tipping over we recommend that it is permanently fixed to the wall.

Wall fixings are not supplied with this product as different wall materials require different types of fixing devices. Please make sure you use fixings suitable for the walls in your home.

