

OLIVER 3 DRAWER CHEST ASSEMBLY INSTRUCTIONS

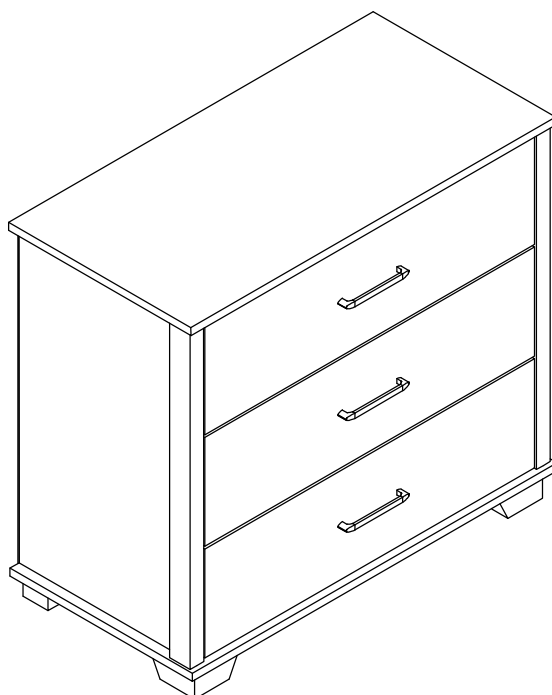
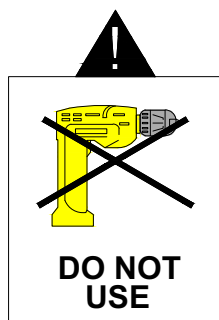

IMPORTANT FOR DOMESTIC USE ONLY PLEASE READ BEFORE YOU CONTINUE FURTHER

THE PRODUCT YOU HAVE PURCHASED WILL GIVE YOU MANY YEARS OF SERVICE IF YOU FOLLOW THE GUIDELINES FOR ITS SAFE ASSEMBLY AND PERIODIC MAINTENANCE AND CLEANING.

ASSEMBLE ON A SOFT CLEAN SURFACE.

DO NOT USE ANY TOOLS OTHER THAN THOSE SHOWN.

ANY SPANNERS OR ALLEN KEYS REQUIRED ARE INCLUDED WITH THE FITTINGS KIT.

DO NOT FOR ANY REASON USE A POWER TOOL TO ASSEMBLE THIS PRODUCT. ITS USE WILL INVALIDATE ANY CLAIM YOU MAY HAVE AND COULD MAKE THIS PRODUCT UNSAFE.

DEPENDING ON THE AMOUNT OF USE THIS PRODUCT RECEIVES IT MAY BE NECESSARY TO TIGHTEN UP THE FIXINGS FROM TIME TO TIME. THIS IS COMPLETELY NORMAL FOR ANY FLAT PACK FURNITURE. DO NOT OVERTIGHTEN FIXING.

FOR CLEANING, YOU MAY USE A DAMP CLOTH (NOT WET) DO NOT USE POLISH, DETERGENT OR CHEMICAL CLEANERS.



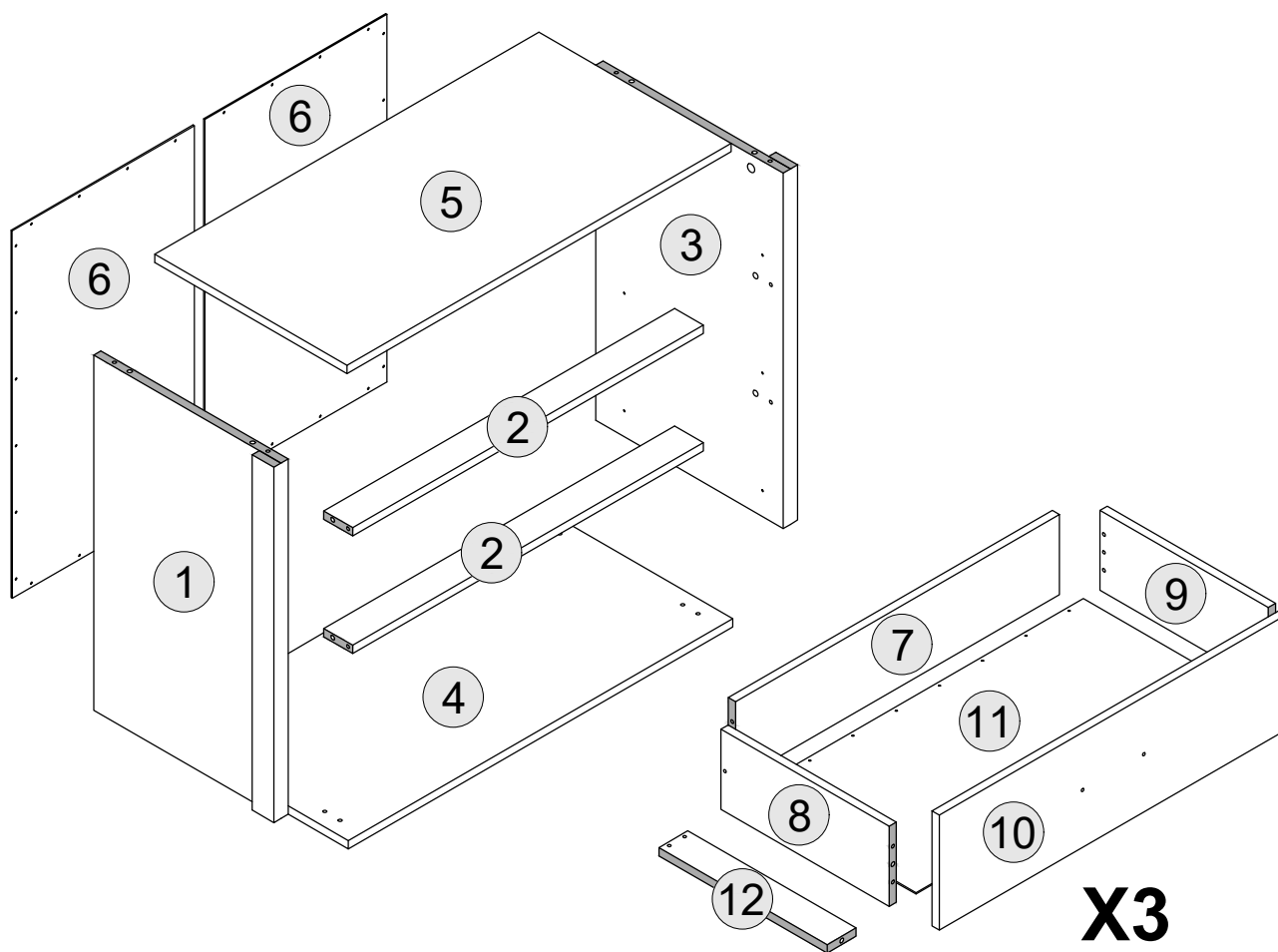













THE SURFACE OF THIS ITEM IS NOT HEAT RESISTANT. ALWAYS USE A PLACE MAT UNDER HOT OR COLD ITEMS TO PREVENT MARKING.

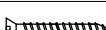
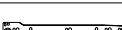

PART LIST

Part Number	Part Code	Part Description	Quantity	Carton
1	S100-102-189-EU1-01	Side Panel - Left	1	1/1
2	S100-102-189-EU1-02	Front Crossbars	2	1/1
3	S100-102-189-EU1-03	Side Panel - Right	1	1/1
4	S100-102-189-EU1-04	Bottom Panel	1	1/1
5	S100-102-189-EU1-05	Top Panel	1	1/1
6	S100-102-189-EU1-06	Back Panel	2	1/1
7	S100-102-189-EU1-07	Drawer Back	3	1/1
8	S100-102-189-EU1-08	Drawer Side - Left	3	1/1
9	S100-102-189-EU1-09	Drawer Side - Right	3	1/1
10	S100-102-189-EU1-10	Drawer Front	3	1/1
11	S100-102-189-EU1-11	Drawer Base	3	1/1
12	S100-102-189-EU1-12	Drawer Base Support Rail	3	1/1

HARDWARE LIST

A		DOWEL 6 X 30MM	36 PCS
B		CAM BOLT + CAM NUT	17 SETS
C		SCREW M6 X 50MM	4 PCS
D		SCREW M3.5 X 16MM	18 PCS
E		TACK	28 PCS
F		SCREW M4 X 32MM	10 PCS
G		HANDLE	3 PCS
H		SCREW M4 X 30MM	6 PCS
I		ALLEN KEY	1 PC
J		HANDLE SCREW 20MM	6 PCS
K		SCREW M3.5 X 12MM	48 PCS
L		L PVC FOOT	2 PCS
M		SQUARE PVC FOOT	2 PCS
N		SCREW M4 X 38MM	6 PCS
O		DRAWER RUNNER A - L/R	6 PCS
P		DRAWER RUNNER B - L/R	6 PCS
Q		PLASTIC H STRIP	1 PC
R		ANTI - TIP STRAP	2 PCS
S		SCREW M4 X 16MM	2 PCS

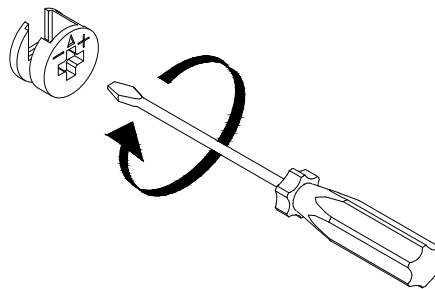

(SCREWDRIVER NOT PROVIDED)

USE A FLAT HEAD SCREWDRIVER TO TIGHTEN THE CAM NUTS. A QUARTER TURN CLOCKWISE IS ALL THAT IS NEEDED.

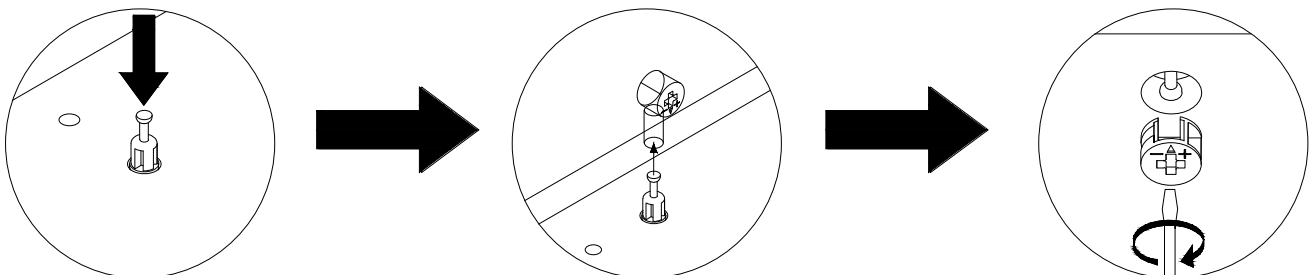

STEP 1 - PUSH CAM BOLT INTO INSERT

STEP 2 - ALIGN THE CAM BOLT WITH THE HOLE AND PUSH TOGETHER UNTIL FLUSH. (MAKE SURE THE ARROW OF THE CAM LOCK IS POINTING TOWARD ON THE EDGE OF THE PANEL.)

STEP 3 - THE HEAD OF THE BOLT GOES INTO THE WIDE MOUTH OF THE CAM LOCK. YOU THEN TURN THE LOCK SO THE NARROW PART CLOSES OVER THE BOLT.

STEP 1

PARTS REQUIRED

1 - SIDE PANEL - LEFT x1

HARDWARE REQUIRED

A  04

B  02

K  12

O  03

TOOLS REQUIRED

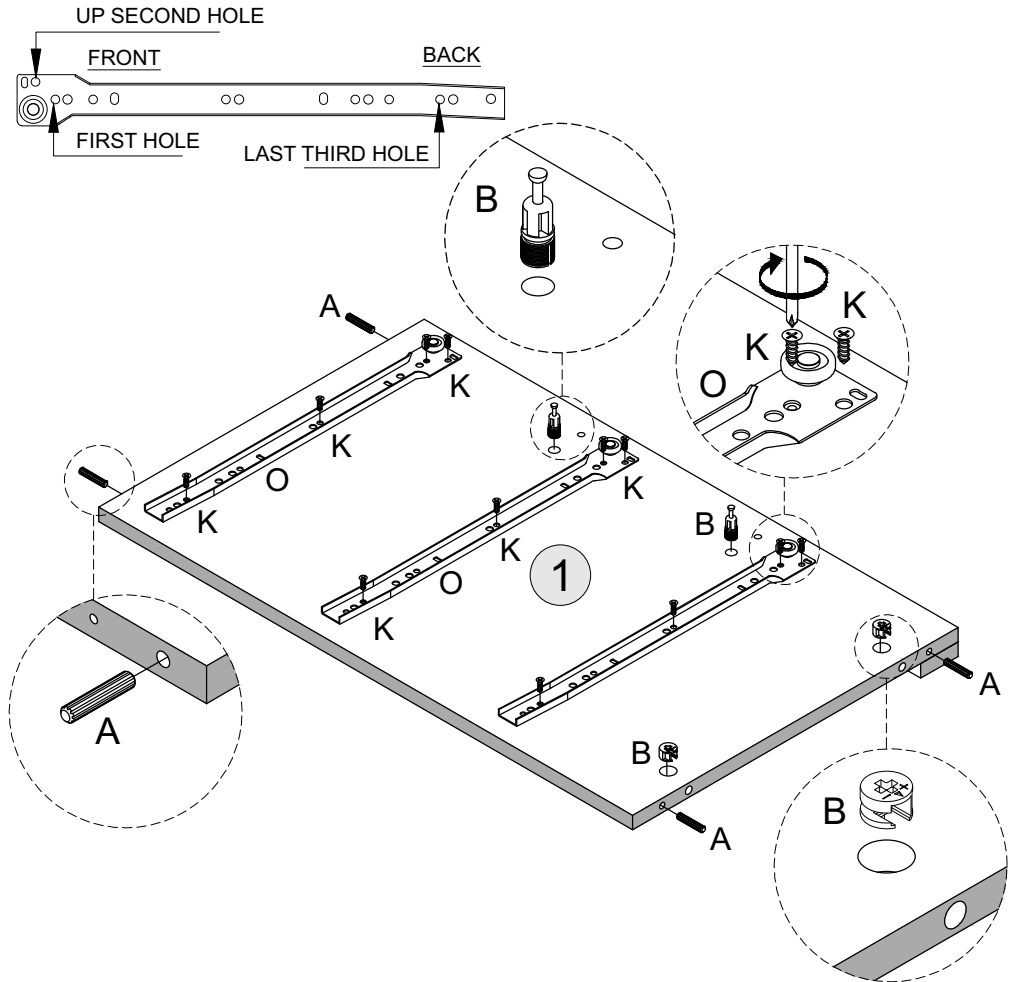
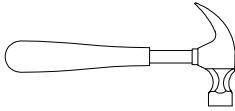
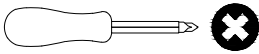

STEP 2

PARTS REQUIRED

3 - SIDE PANEL - RIGHT x1

HARDWARE REQUIRED

A  04

B  02

K  12

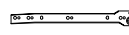
O  03

TOOLS REQUIRED

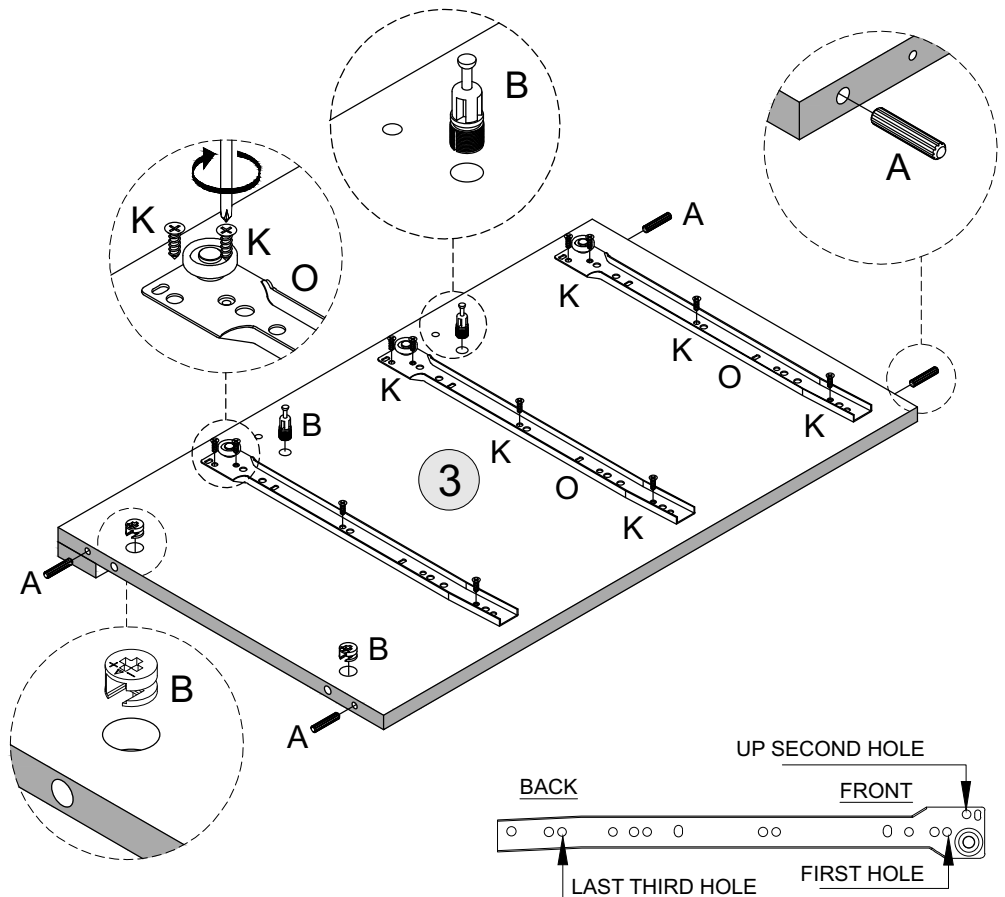
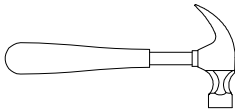
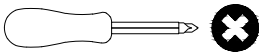

STEP 3

PARTS REQUIRED

2 - FRONT CROSSBARS x2

5 - TOP PANEL x1

HARDWARE REQUIRED

A  04

B  04

TOOLS REQUIRED

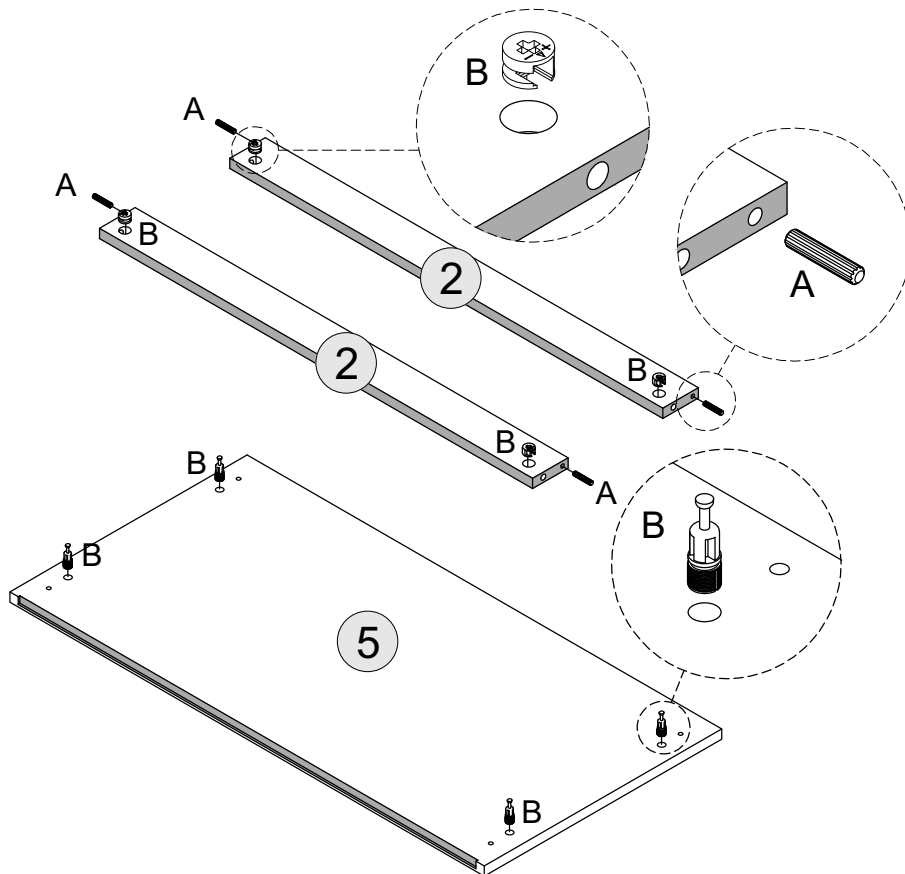
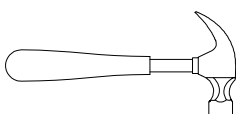

STEP 4

PARTS REQUIRED

1 - SIDE PANEL - LEFT x1

2 - FRONT CROSSBARS x2

HARDWARE REQUIRED

TOOLS REQUIRED

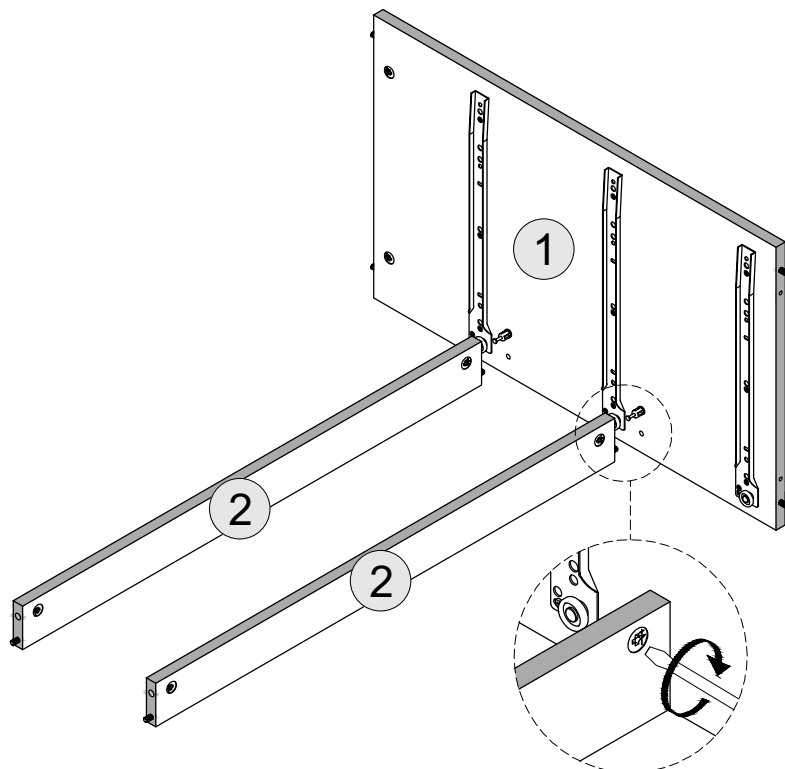
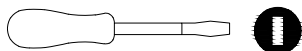

STEP 5

PARTS REQUIRED

3 - SIDE PANEL - RIGHT x1

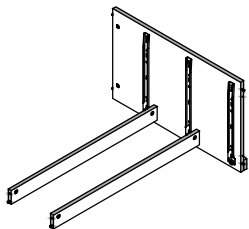

HARDWARE REQUIRED

TOOLS REQUIRED

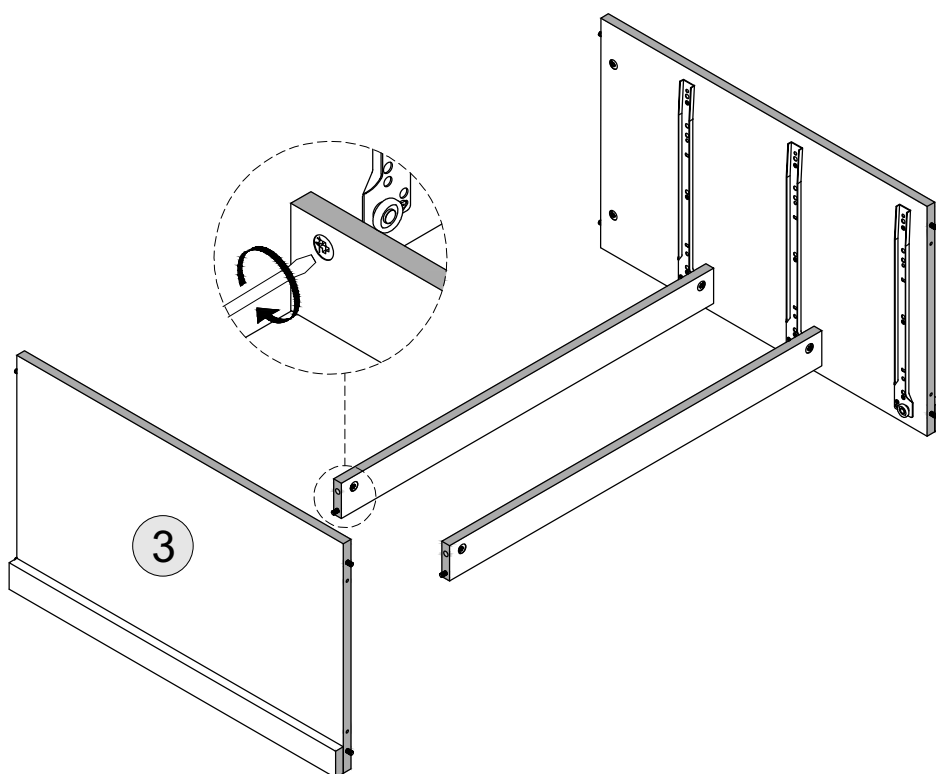
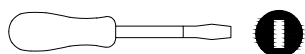

STEP 6

PARTS REQUIRED

4 - BOTTOM PANEL x1

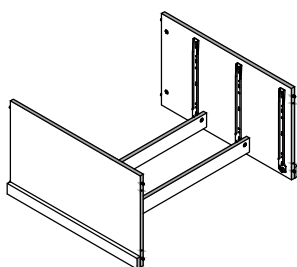

HARDWARE REQUIRED

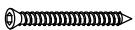
C  04

TOOLS REQUIRED

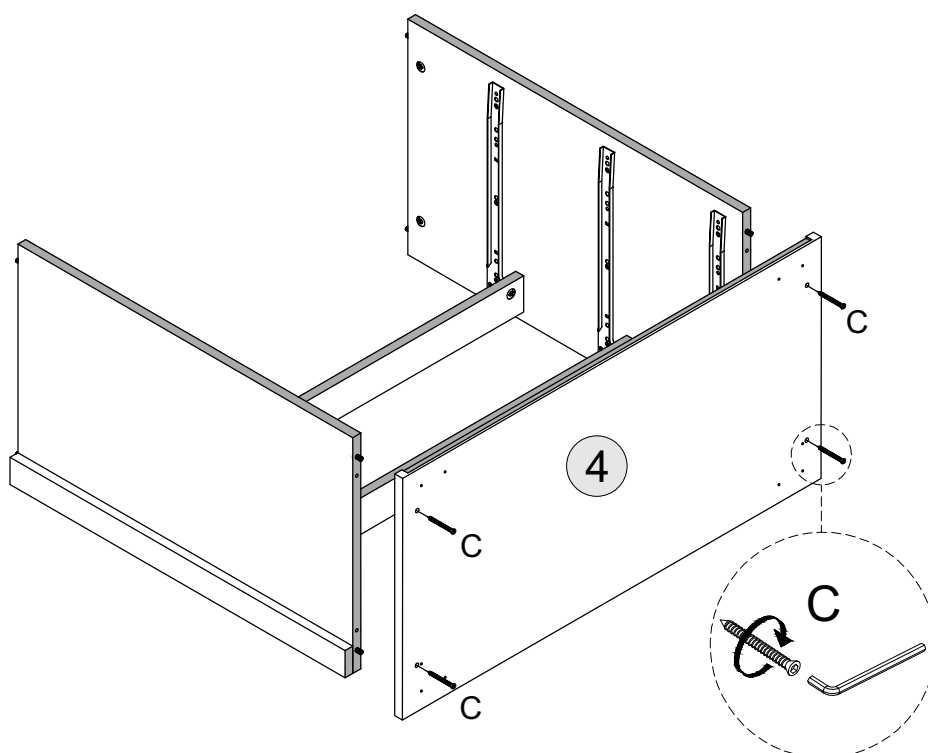
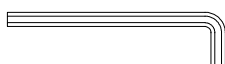

STEP 7

PARTS REQUIRED

5 - TOP PANEL x1

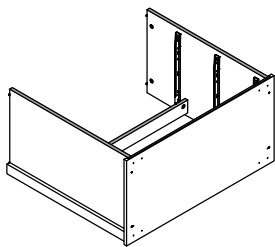

HARDWARE REQUIRED

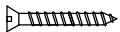
F  10

L  02

M  02

TOOLS REQUIRED

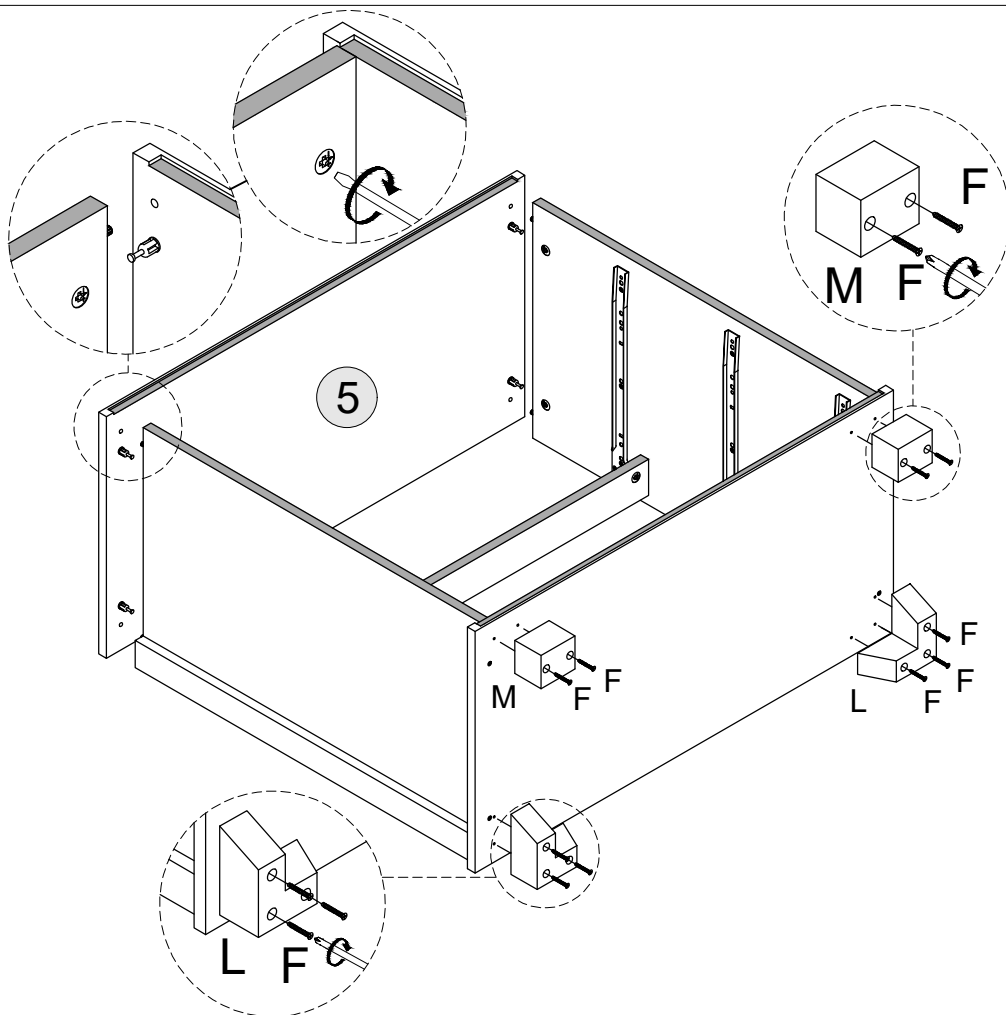
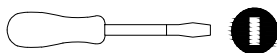
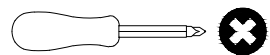

STEP 8

PARTS REQUIRED

6 - BACK PANEL x2

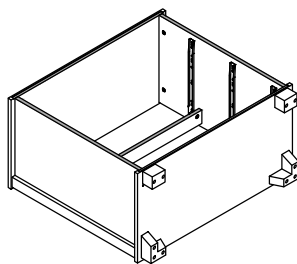

HARDWARE REQUIRED

E  28

Q  01

TOOLS REQUIRED

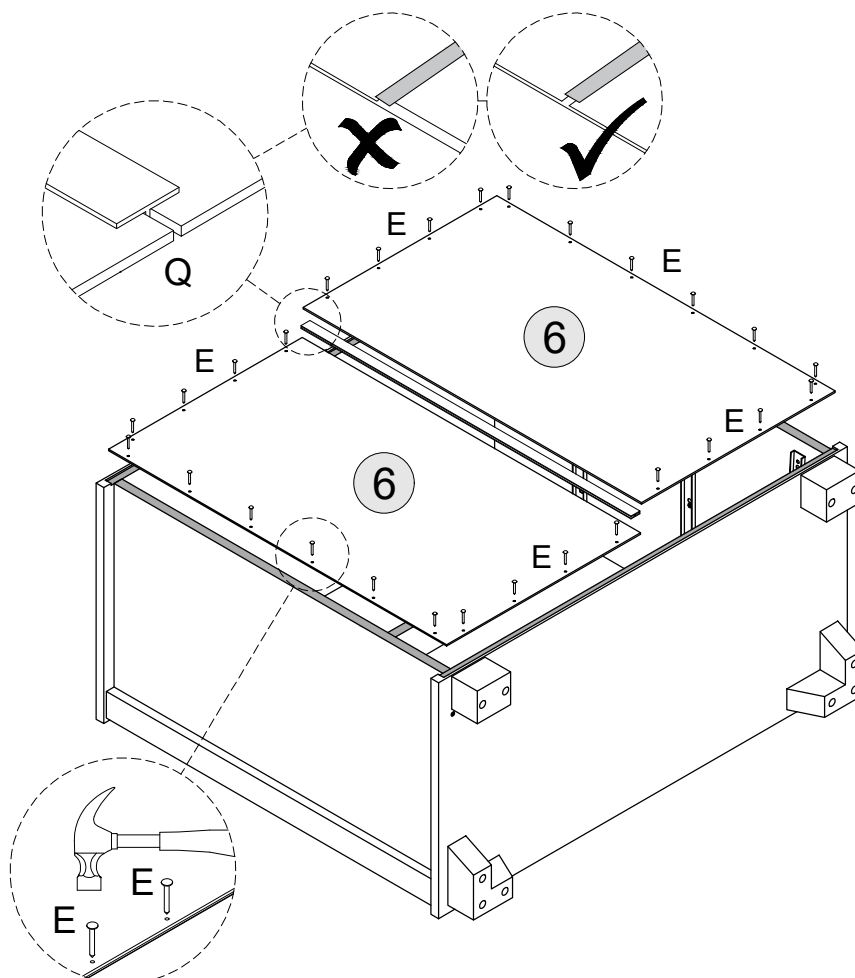
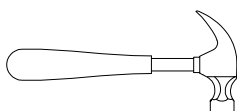



STEP 9

PARTS REQUIRED

7 - DRAWER BACK	x3
8 - DRAWER SIDE-LEFT	x3
9 - DRAWER SIDE-RIGHT	x3
10 - DRAWER FRONT	x3

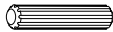
HARDWARE REQUIRED

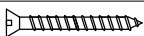
A		24
B		09
B		06
N		06

TOOLS REQUIRED

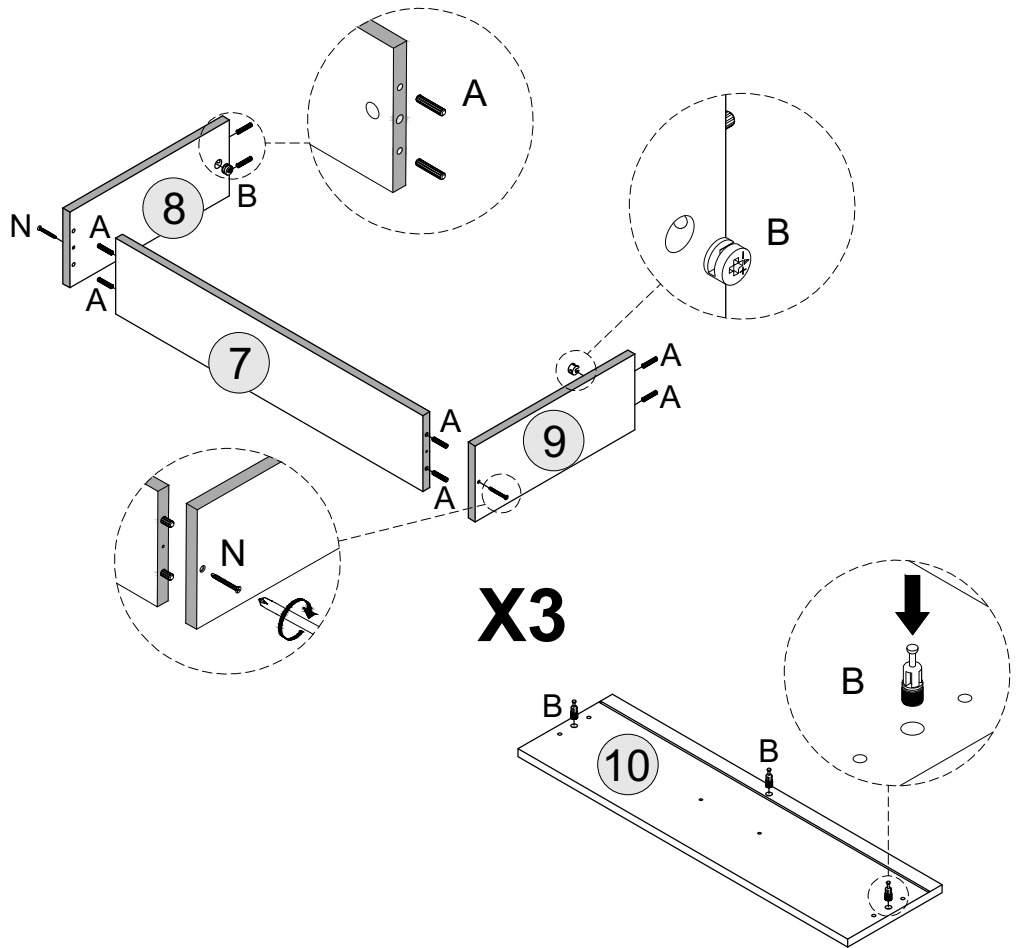
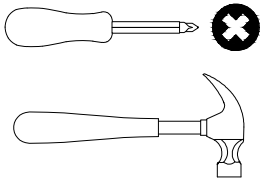



STEP 10

PARTS REQUIRED

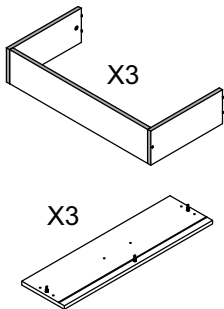
11 - DRAWER BASE	x3
------------------	----



HARDWARE REQUIRED

G		03
J		06
K		24

TOOLS REQUIRED

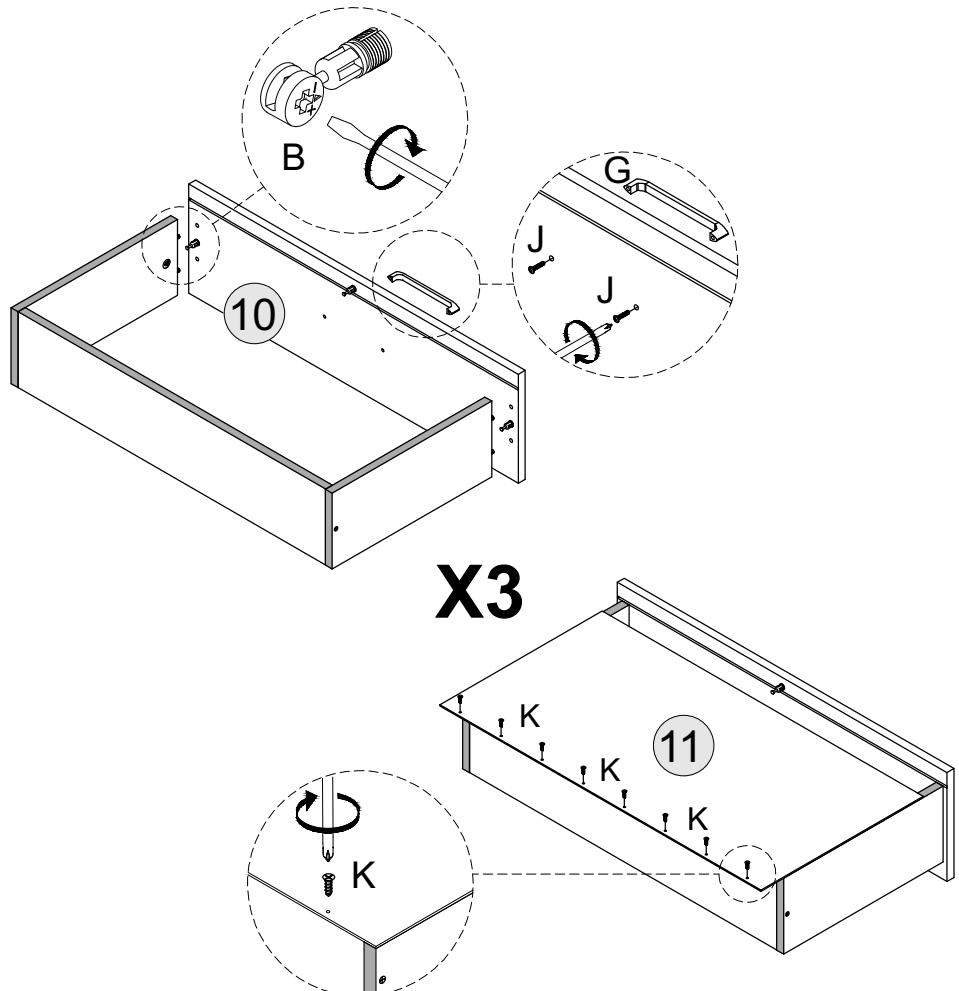
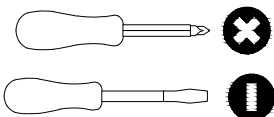

STEP 11

PARTS REQUIRED

12 -DRAWER BASE SUPPORT RAIL x3

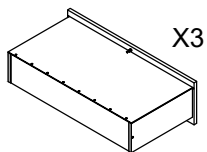

HARDWARE REQUIRED

B  03

D  18

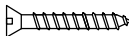
H  06

P  06

TOOLS REQUIRED

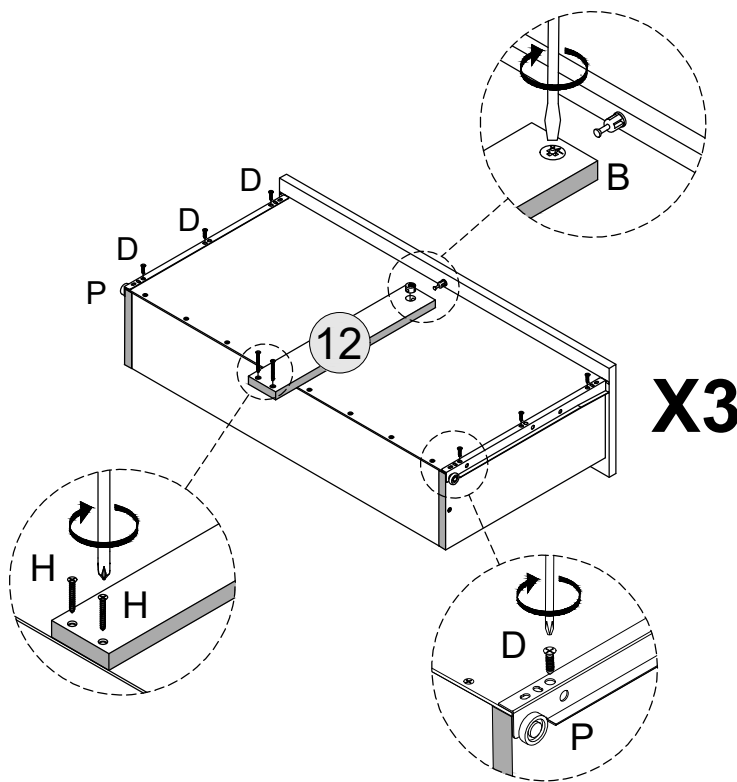
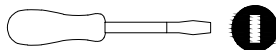

STEP 12

PARTS REQUIRED

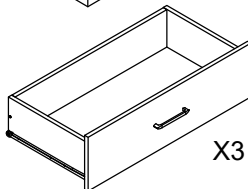
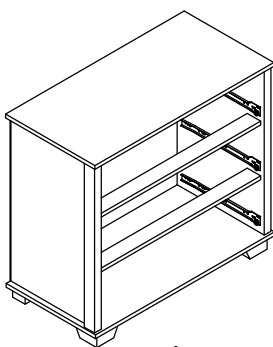

HARDWARE REQUIRED

TOOLS REQUIRED

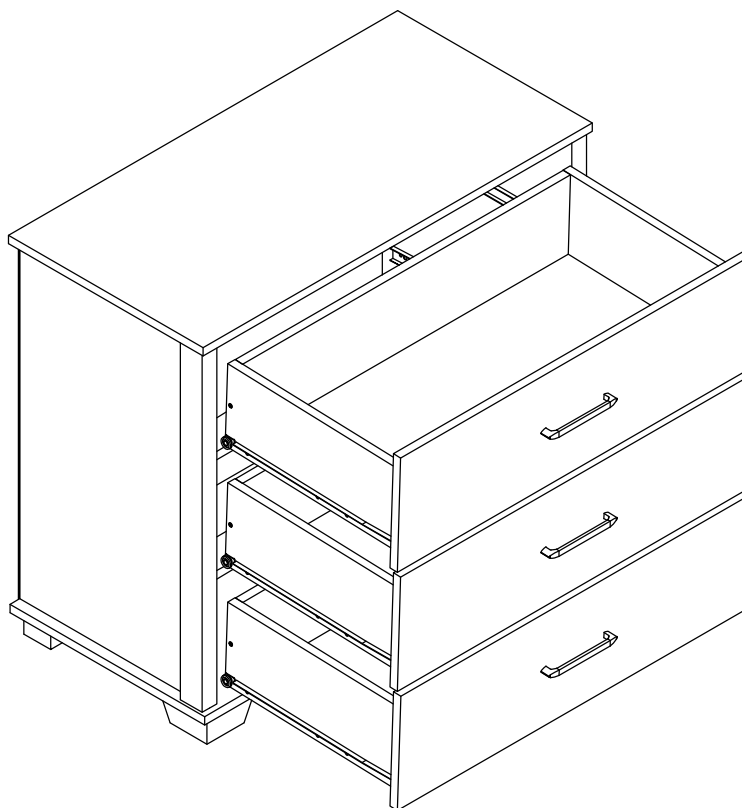

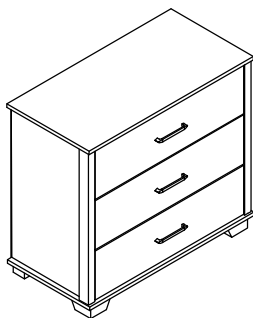
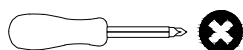
STEP 13PART REQUIREDHARDWARE REQUIREDR  02S  02TOOLS REQUIRED**WARNING**

Serious or fatal injuries can occur from furniture tipping over. To prevent the furniture from tipping over we recommend that it is permanently fixed to the wall.

Wall fixings are not supplied with this product as different wall materials require different types of fixing devices. Please make sure you use fixings suitable for the walls in your home.

