

NEVADA 5 DRAWER NARROW CHEST ASSEMBLY INSTRUCTIONS

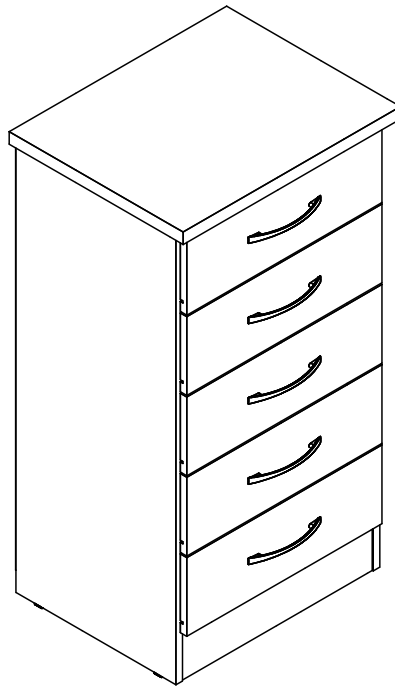

IMPORTANT FOR DOMESTIC USE ONLY

PLEASE READ BEFORE YOU CONTINUE FURTHER

CARE AND MAINTENANCE

After unpacking this product please keep the original packaging in case it needs to be returned for any reason.

- Please ensure all fittings and parts are present before commencing with assembly.
- Never drag or push products as this could cause damage to the joints making it inferior.
- We strongly recommend that you keep children away from your work area.
- We recommend that you lay a blanket or sheet on the floor to avoid damage to both your floor and the product.
- Assemble this product as close to its final position as possible.
- Do not place this product next to a radiator or in direct sunlight.
- Do not drag or push items across your high gloss furniture as this may cause the surface to scratch
- Wood is a natural product and may expand if subjected to damp and may shrink or crack if subjected to heat. Therefore it is recommended that room temperature is maintained, with no sudden temperature fluctuations.
- Make sure any spillage is wiped off immediately.
- Do not place hot or chilled items directly on to the surface, use a place mat or marking will occur.
- For general cleaning use a soft cotton or micro fibre cloth, and do not use detergents of any kind.
- From time to time it may be necessary to tighten fittings, regular inspections should be carried out.
- Do not place on a wet or damp floor as staining may occur to your floor.

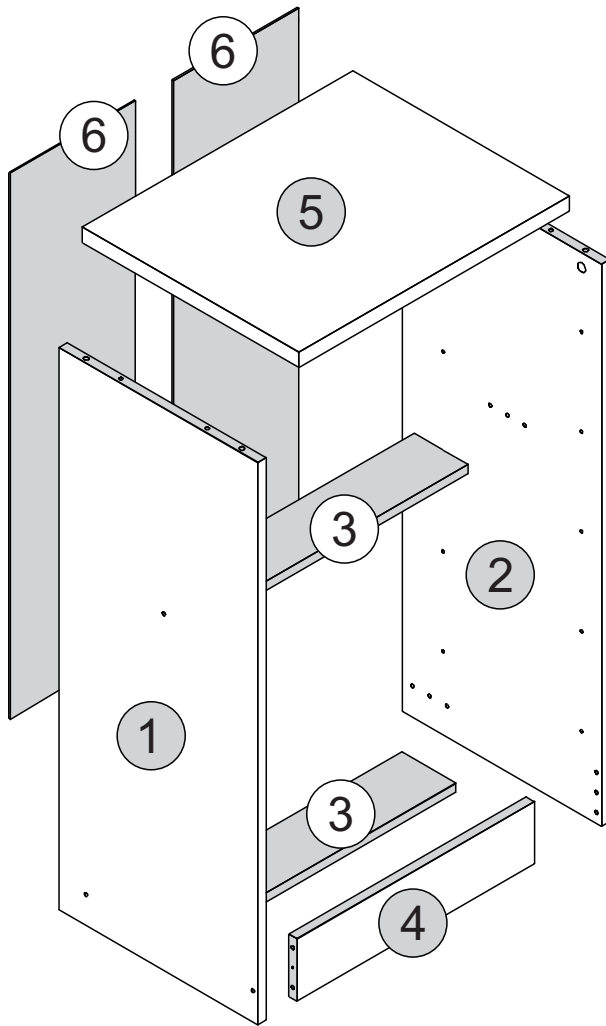

TOOLS REQUIRED

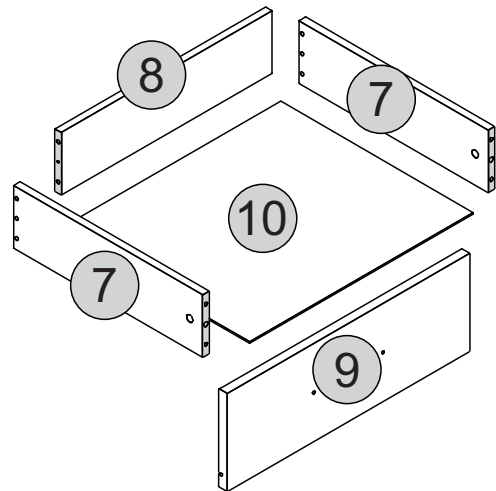
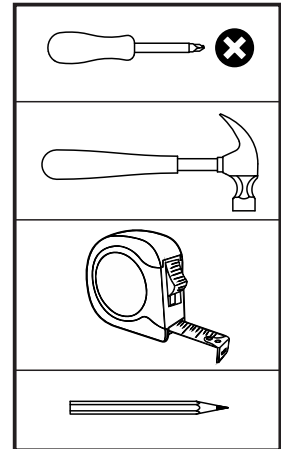









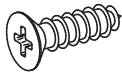
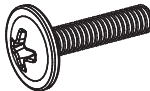
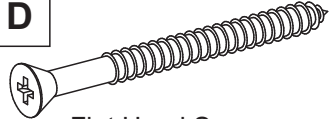

PARTS LIST

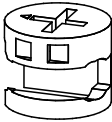
Please Note:
The below parts have all been stamped with the part number to help identify them during assembly.

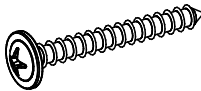
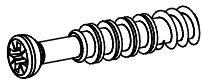
Part Number	Part Description	Quantity	Carton
01	Left Side Panel	1	1/1
02	Right Side Panel	1	1/1
03	Back Baseboard	2	1/1
04	Front Baseboard	1	1/1
05	Top Panel	1	1/1
06	Back Panel	2	1/1
07	Drawer Side	10	1/1
08	Drawer Back Panel	5	1/1
09	Drawer Front	5	1/1
10	Drawer Bottom	5	1/1

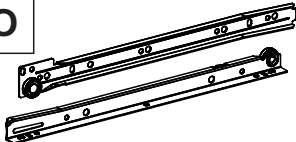
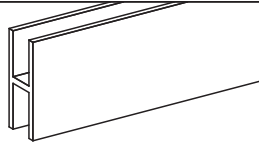
FITTINGS LIST

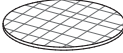
<p>A</p>  <p>Flat Head Screw 2/+ Ø6,0 x 10mm (20x)</p>	<p>B</p>  <p>Flat Head Screw 2/+ Ø4,0 x 14mm (30x)</p>	<p>C</p>  <p>Flan Head Screw 2/+ Ø4,0 x 20mm (10x)</p>	<p>D</p>  <p>Flat Head Screw 2/+ Ø4,0 x 50mm (16x)</p>
<p>E</p>  <p>2/+ Dowel Ø6,0 x 30mm (56x)</p>	<p>F</p>  <p>2/+ Nail 10 x 10 (74x)</p>	<p>G</p>  <p>2/+ Cam Nut Ø12mm (10x)</p>	<p>H</p>  <p>1/+ Cam Nut Ø15mm (4x)</p>
<p>I</p>  <p>1/+ Washer (2x)</p>	<p>J</p>  <p>1/+ Plastic Foot (4x)</p>	<p>K</p>  <p>1/+ Flan Head Screw Ø3,5 x 30mm (1x)</p>	<p>L</p>  <p>2/+ Cam Bolt (14x)</p>
<p>M</p>  <p>2/+ Hole Plugs (6x)</p>	<p>N</p>  <p>Glue (2x)</p>	<p>O</p>  <p>Drawer Runners (5x)</p>	<p>P</p>  <p>Back Panel Strip (1x)</p>
<p>Q</p>  <p>Strap (1x)</p>	<p>R</p>  <p>Handle (5x)</p>	<p>S</p>  <p>2/+ Hole Plugs (10x)</p>	

TIPS FOR FITTINGS CAM-LOCKS

WHEN FITTING CAM NUT. ENSURE STARTING POSITION IS CORRECT BEFORE YOU INSERT CONNECTING CAM BOLT TURN CLOCKWISE UNTIL SECURE



↑

CORRECT



↑

WRONG

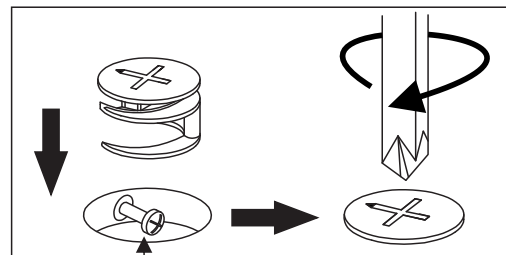

Cam bolt head needs to be in centre

CAMBOLT

Tighten until shoulder in flush with panel. Do not overtighten or undertighten (see example beside)

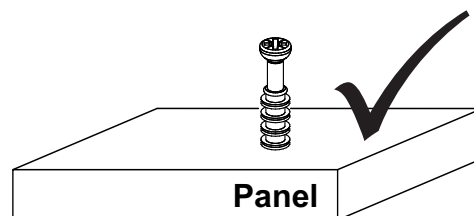
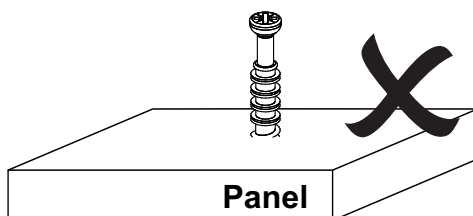
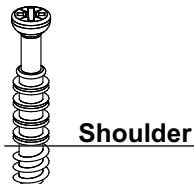



STEP 1

PARTS REQUIRED

1 - LEFT SIDE PANEL x1

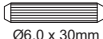
HARDWARE REQUIRED

E  02
Ø6,0 x 30mm

F  02
10 x 10

J  02

N  01
GLUE

TOOLS REQUIRED

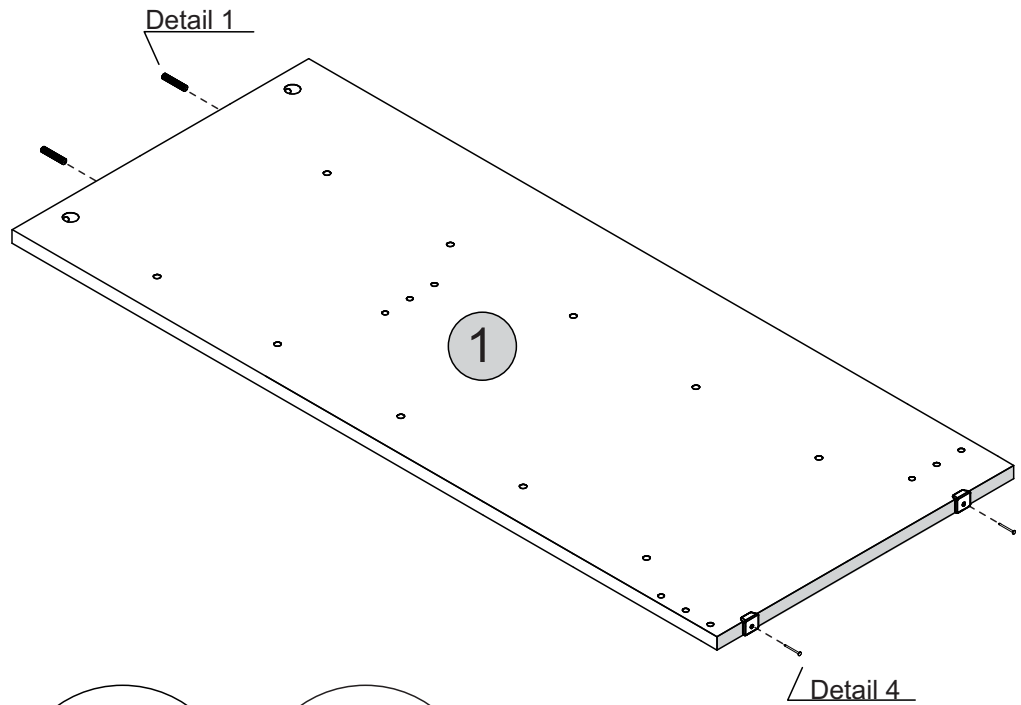
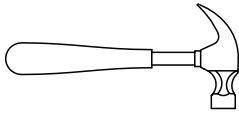

Detail 1

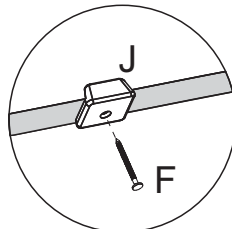

Detail 4

STEP 2

PARTS REQUIRED

2 - RIGHT SIDE PANEL x1

HARDWARE REQUIRED

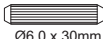
E  02
Ø6,0 x 30mm

F  02
10 x 10

J  02

N  01
GLUE

TOOLS REQUIRED

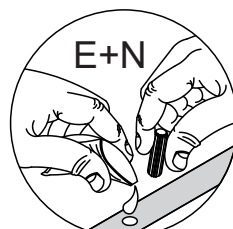
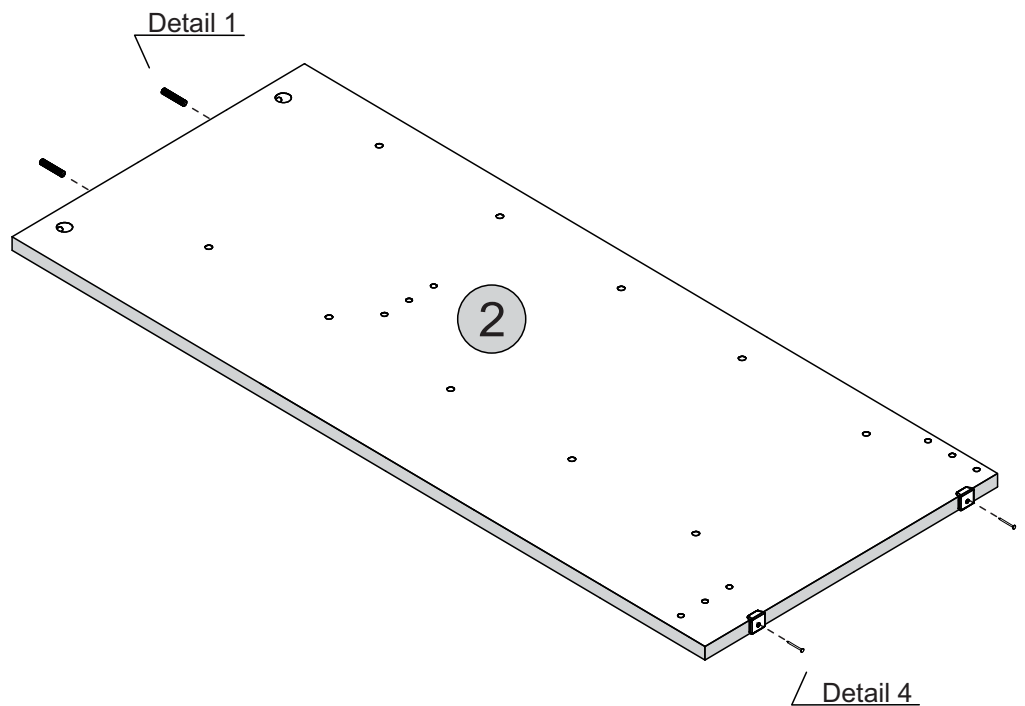
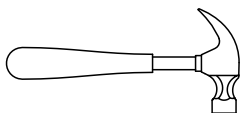

Detail 1

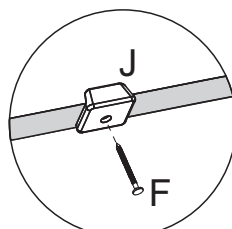

Detail 4

STEP 3

PARTS REQUIRED

2 - RIGHT SIDE PANEL x1

HARDWARE REQUIRED

A  10
Ø6,0 x 10mm

B  05
Ø4,0 x 14mm

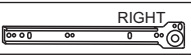
O  05
RIGHT

TOOLS REQUIRED

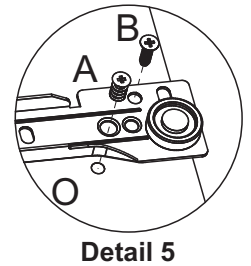
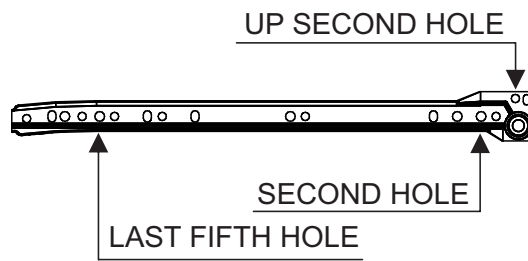
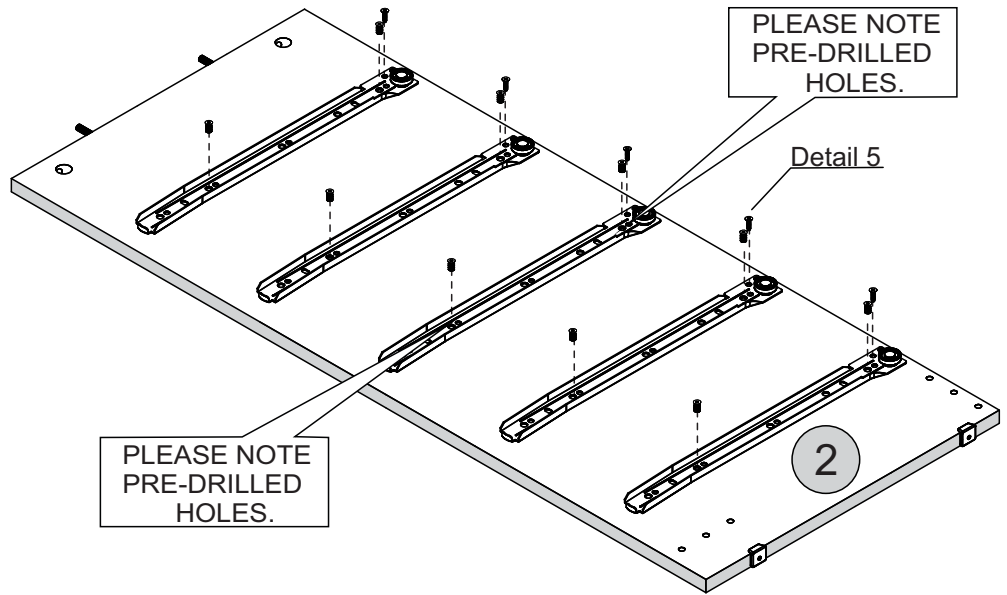
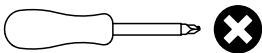

STEP 4

PARTS REQUIRED

1 - LEFT SIDE PANEL x1

HARDWARE REQUIRED

A  10
Ø6,0 x 10mm

B  05
Ø4,0 x 14mm

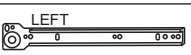
O  05
LEFT

TOOLS REQUIRED

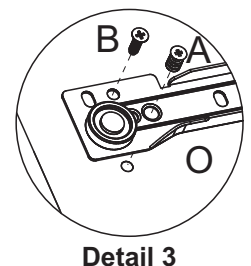
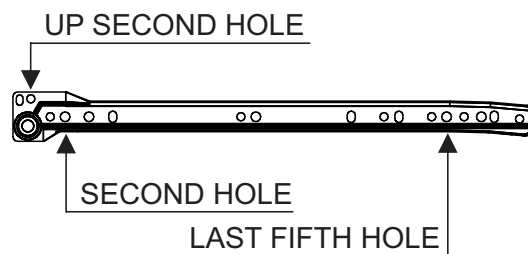
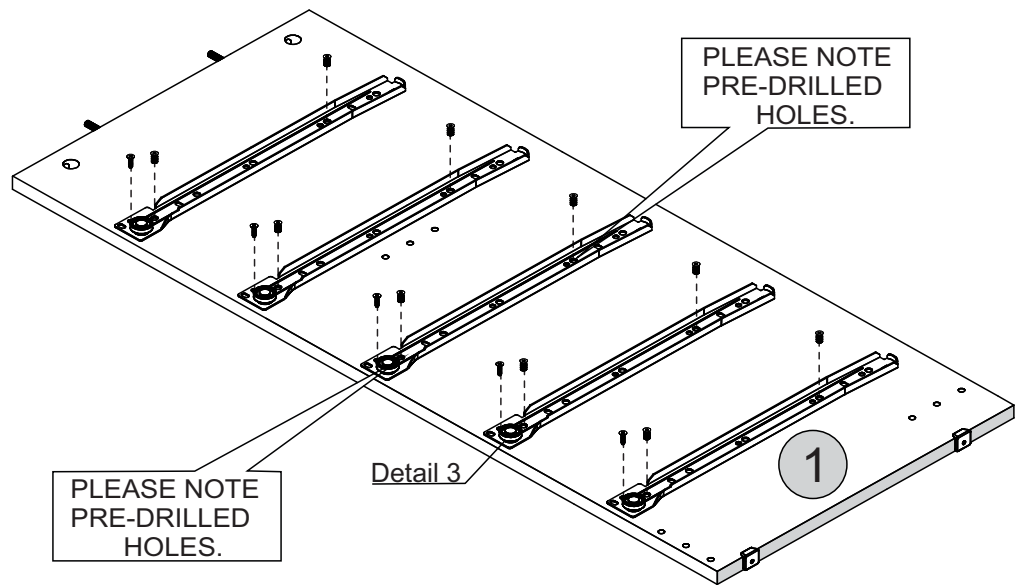
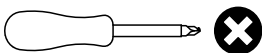

STEP 5

PARTS REQUIRED

3 - BACK BASEBOARD x2

4 - FRONT BASEBOARD x1

HARDWARE REQUIRED

E  12
Ø6,0 x 30mm

N  01

TOOLS REQUIRED

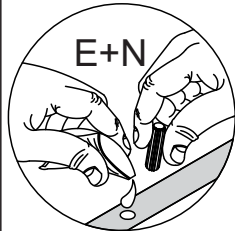

Detail 1

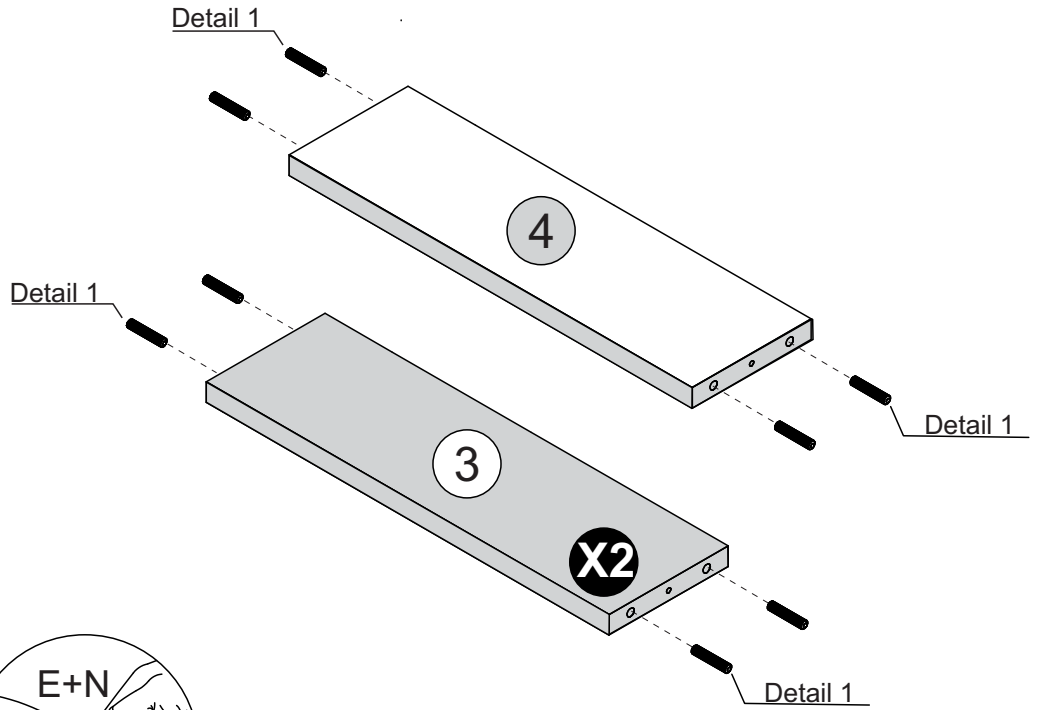

STEP 6

PARTS REQUIRED

2 - RIGHT SIDE PANEL x1

3 - BACK BASEBOARD x2

4 - FRONT BASEBOARD x1

HARDWARE REQUIRED

D  03
Ø4,0 x 50mm

K  01

TOOLS REQUIRED

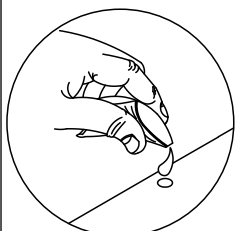
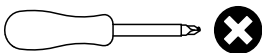

Detail 1

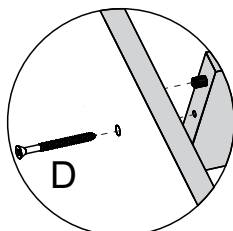

Detail 6

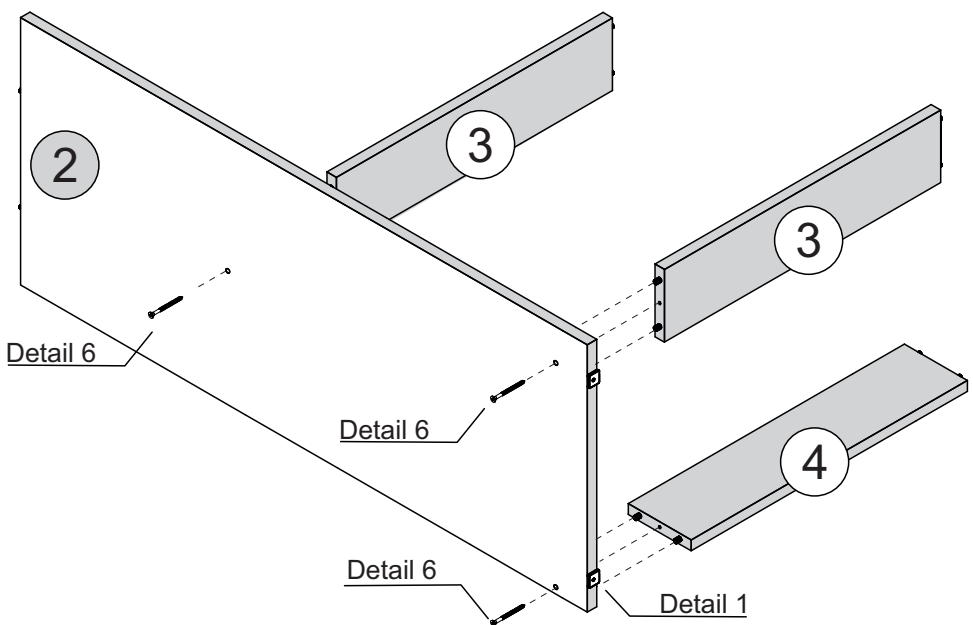

STEP 7

PARTS REQUIRED

1 - LEFT SIDE PANEL x1

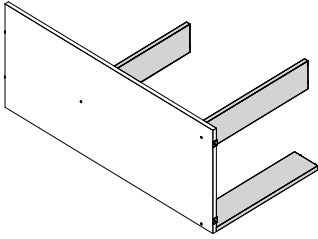

HARDWARE REQUIRED

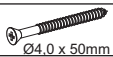
D  03
Ø4,0 x 50mm

K  01
GLUE

TOOLS REQUIRED

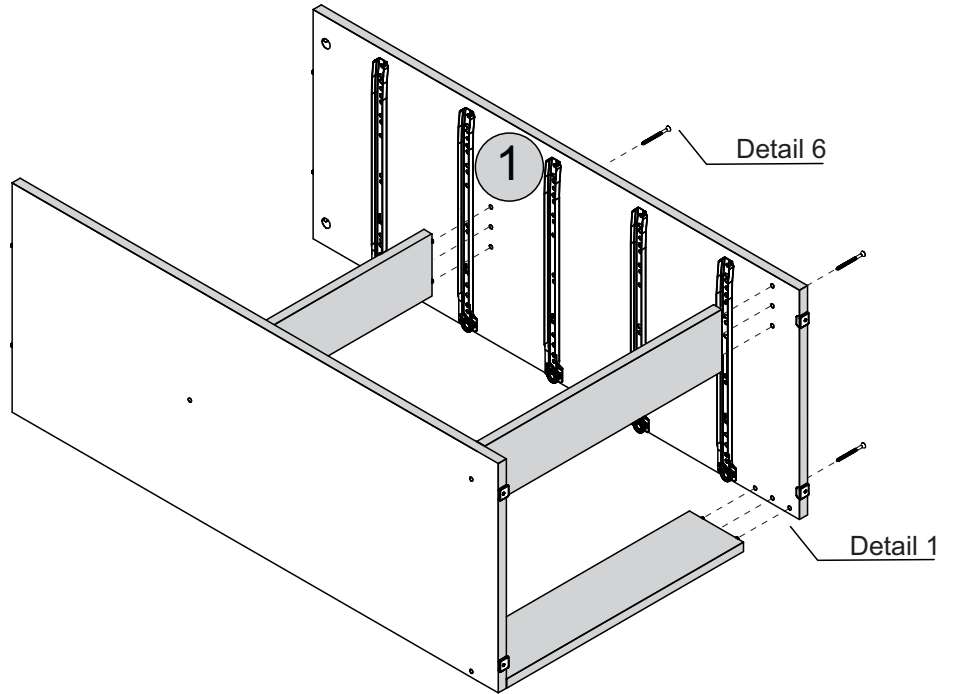
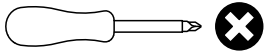

Detail 1

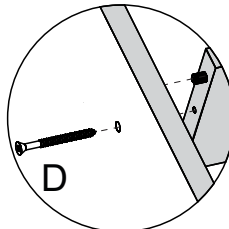

Detail 6

STEP 8

PARTS REQUIRED

5 - TOP PANEL x1

HARDWARE REQUIRED

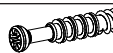
L  04

TOOLS REQUIRED

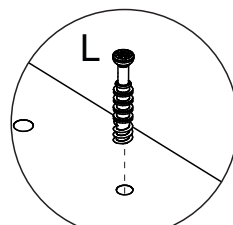
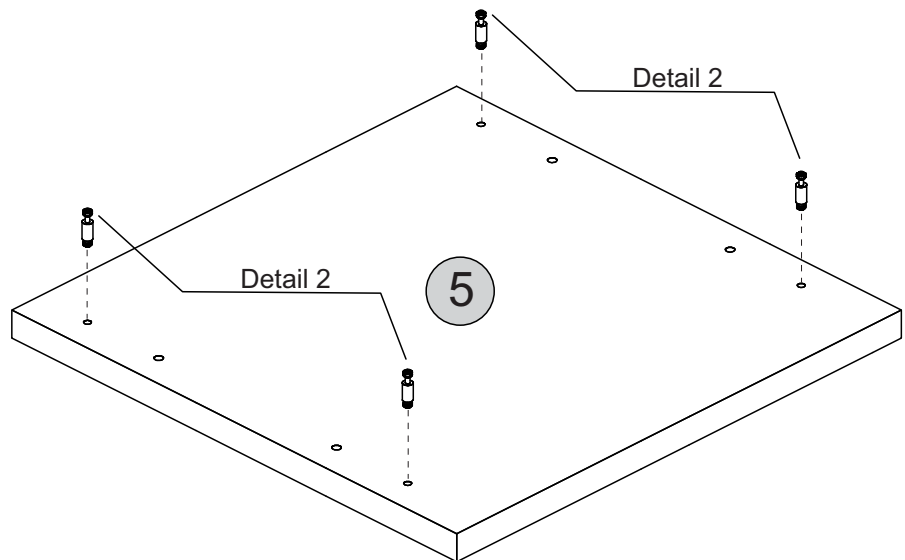
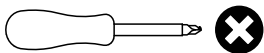

Detail 2

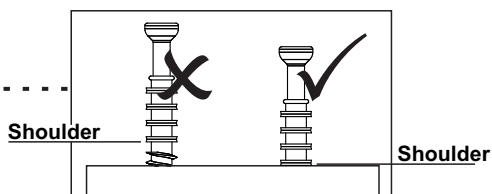

Shoulder

Shoulder

STEP 9

PARTS REQUIRED

5 - TOP PANEL x1

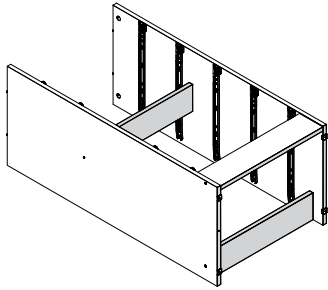

HARDWARE REQUIRED

H  04

N  01

TOOLS REQUIRED

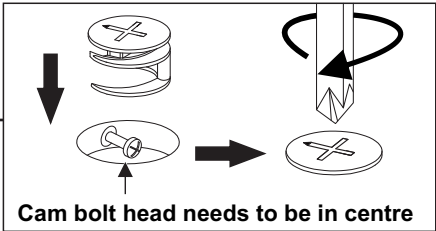
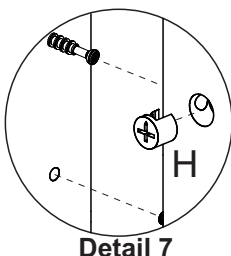
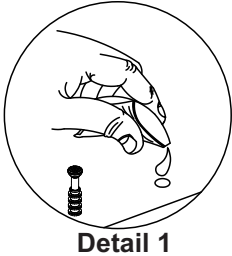
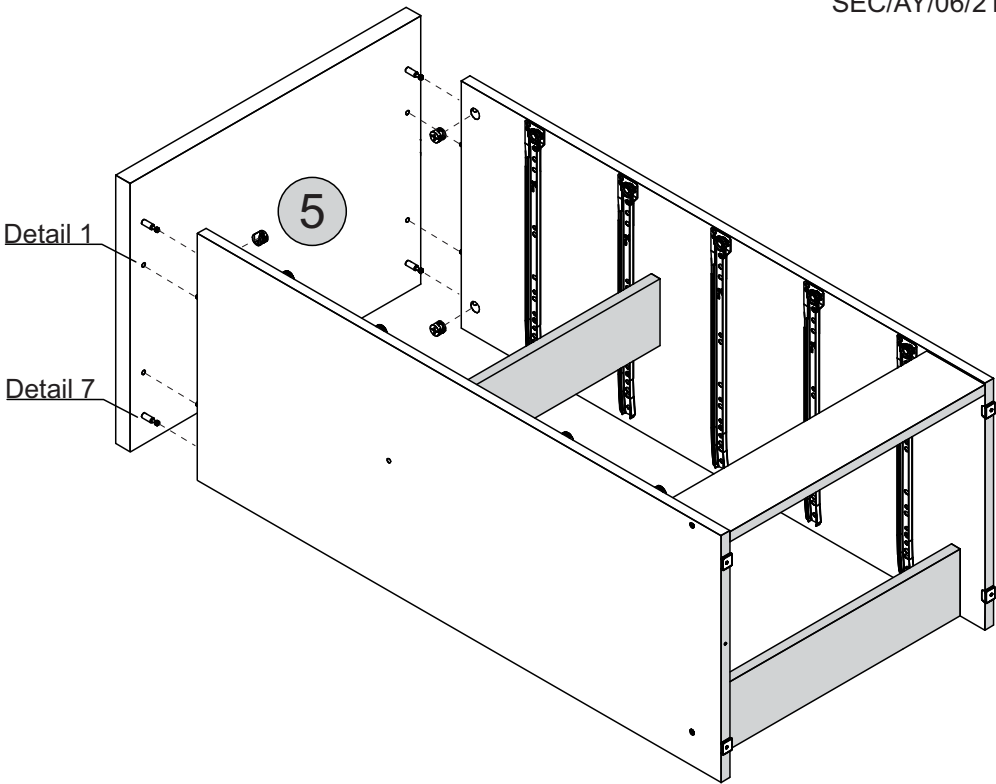
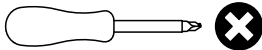

STEP 10

PARTS REQUIRED

6 - BACK PANEL x2

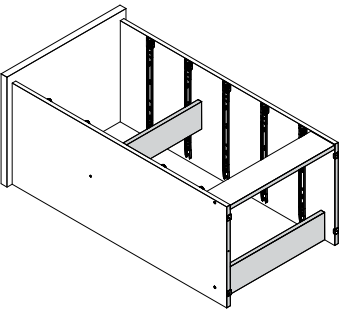

HARDWARE REQUIRED

F  30

P  01

TOOLS REQUIRED

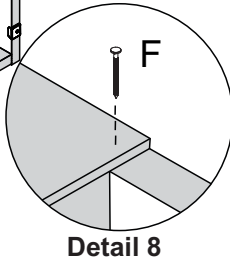
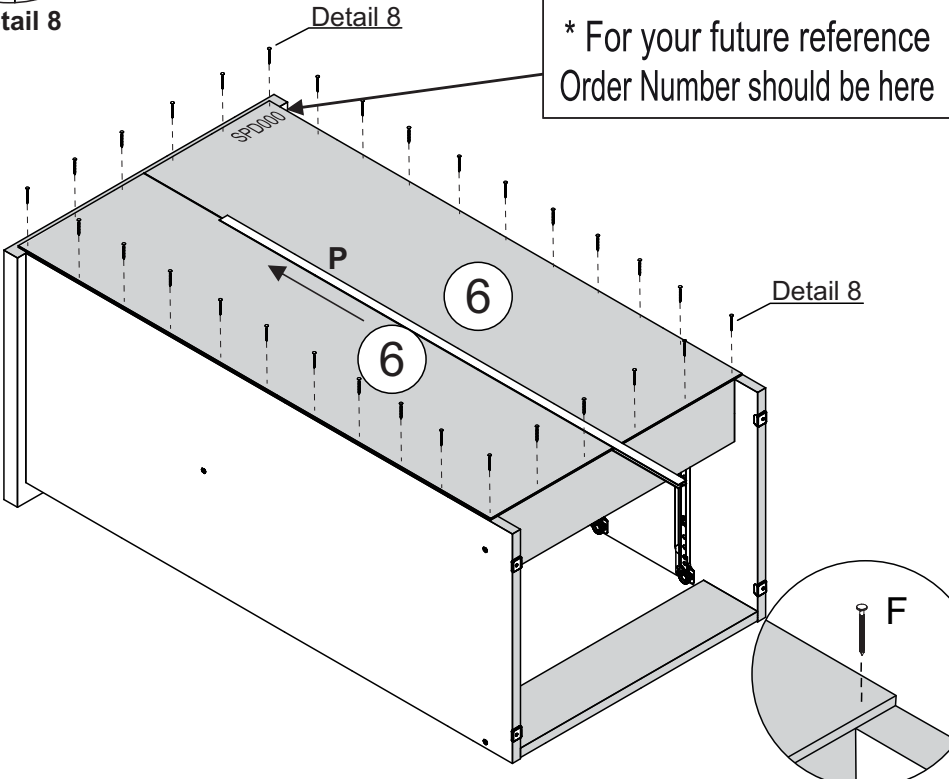
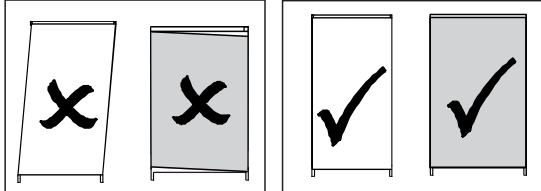
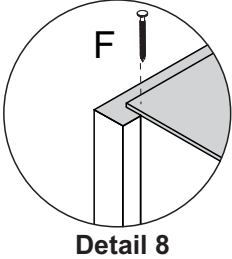
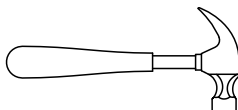

STEP 11

PARTS REQUIRED

7 - DRAWER SIDE x10

8 - DRAWER BACK PANEL x5

HARDWARE REQUIRED

E  40
Ø6,0 x 30mm

N  01
GLUE

TOOLS REQUIRED

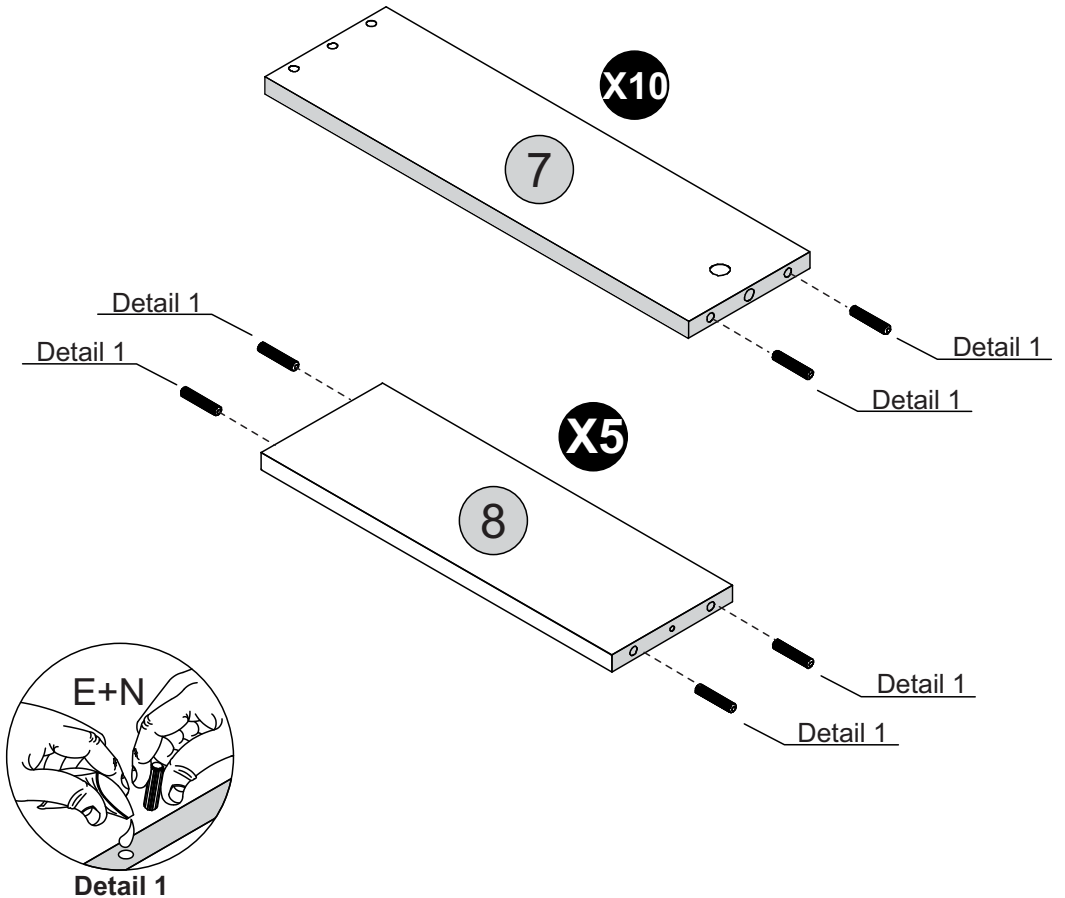

STEP 12

PARTS REQUIRED

9 - DRAWER FRONT x5

HARDWARE REQUIRED

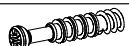
L  10

TOOLS REQUIRED

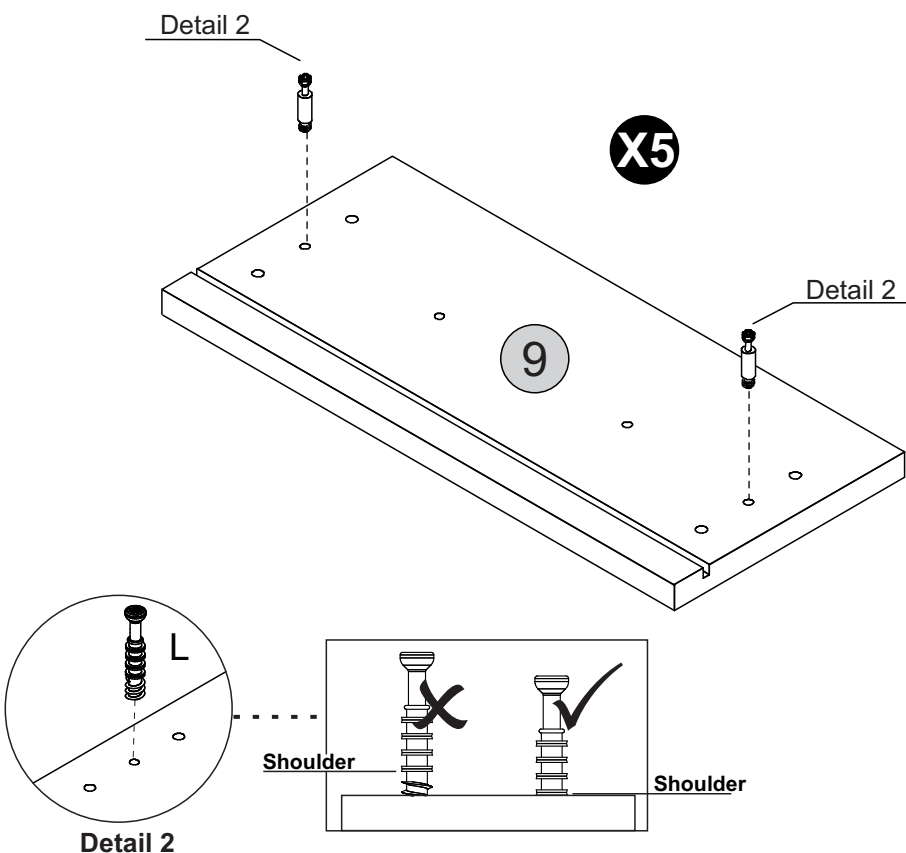
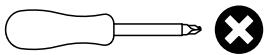

STEP 13

PARTS REQUIRED

7 - DRAWER SIDE x10

8 - DRAWER BACK PANEL x5

HARDWARE REQUIRED

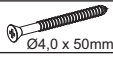
D  10
Ø4,0 x 50mm

TOOLS REQUIRED

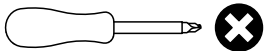

X5

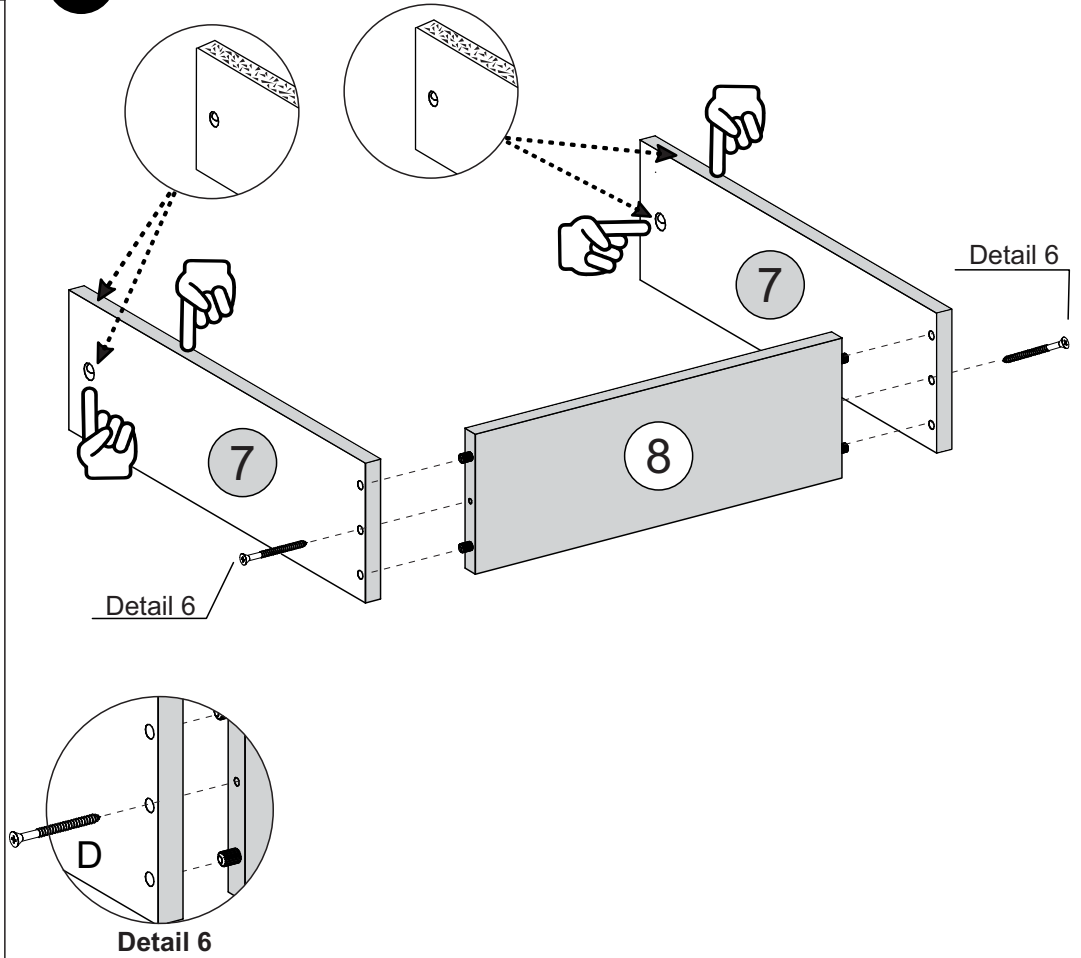

STEP 14

PARTS REQUIRED

9 - DRAWER FRONT x5

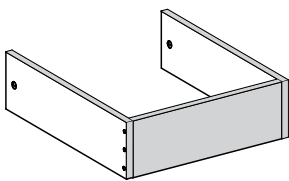

HARDWARE REQUIRED

G  10

N  01
GLUE

TOOLS REQUIRED

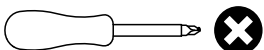

X5

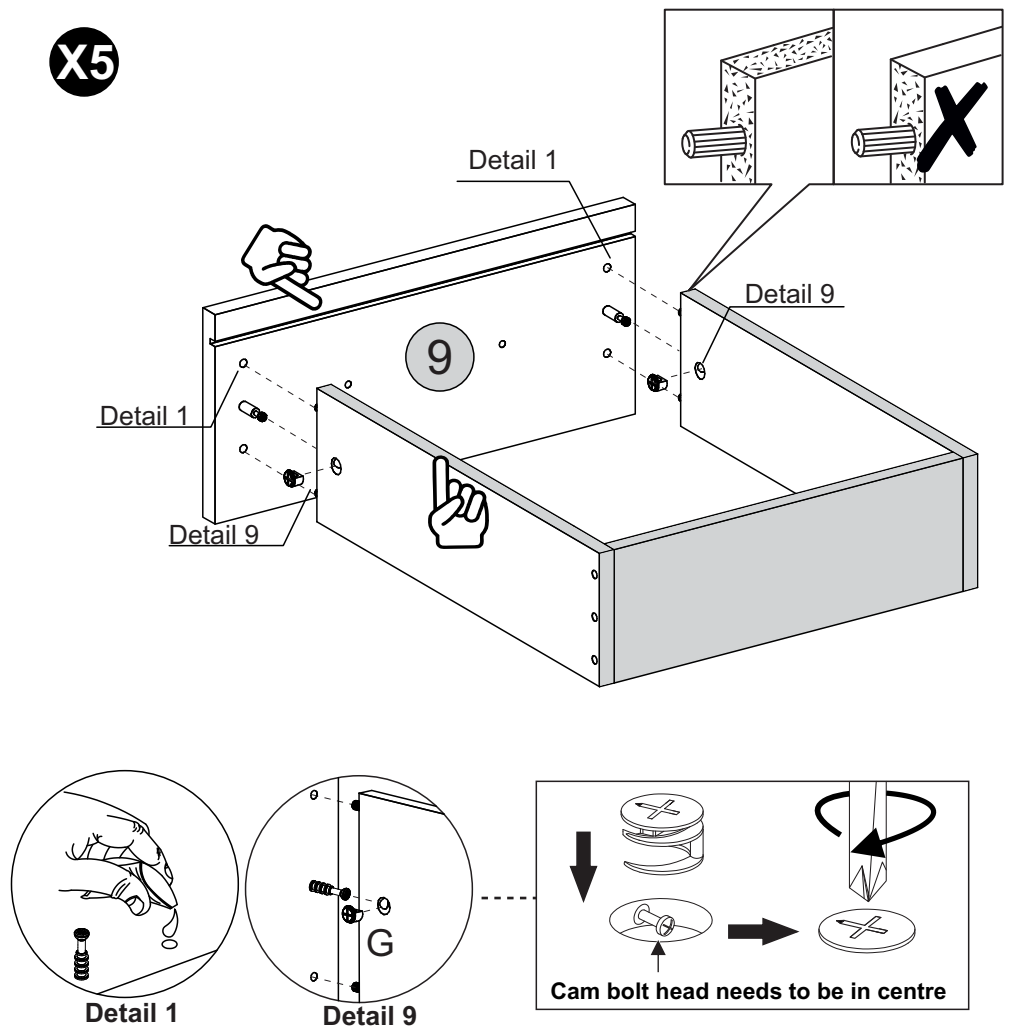

STEP 15

PARTS REQUIRED

10 - DRAWER BOTTOM x5

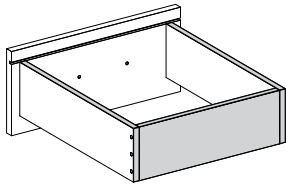

HARDWARE REQUIRED

F  20
10 x 10

TOOLS REQUIRED

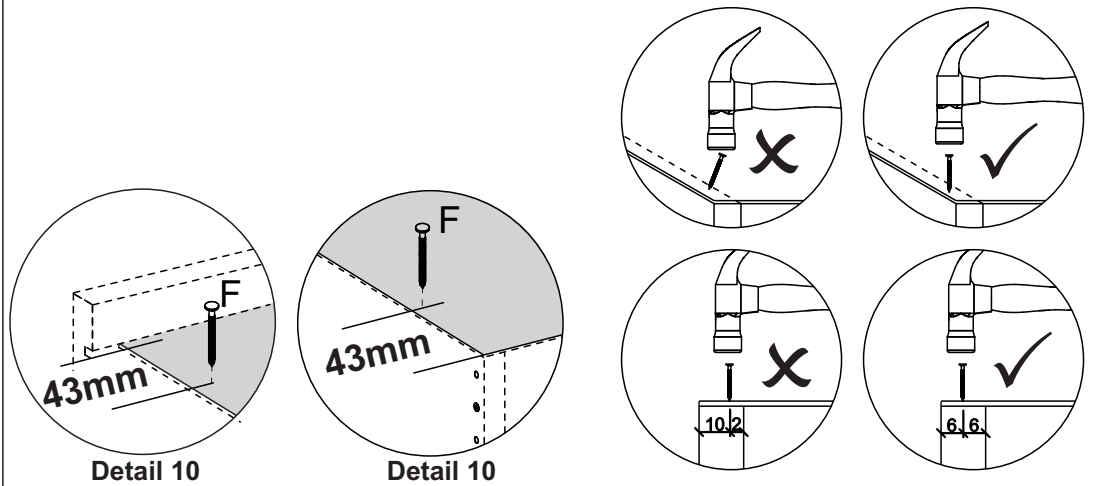
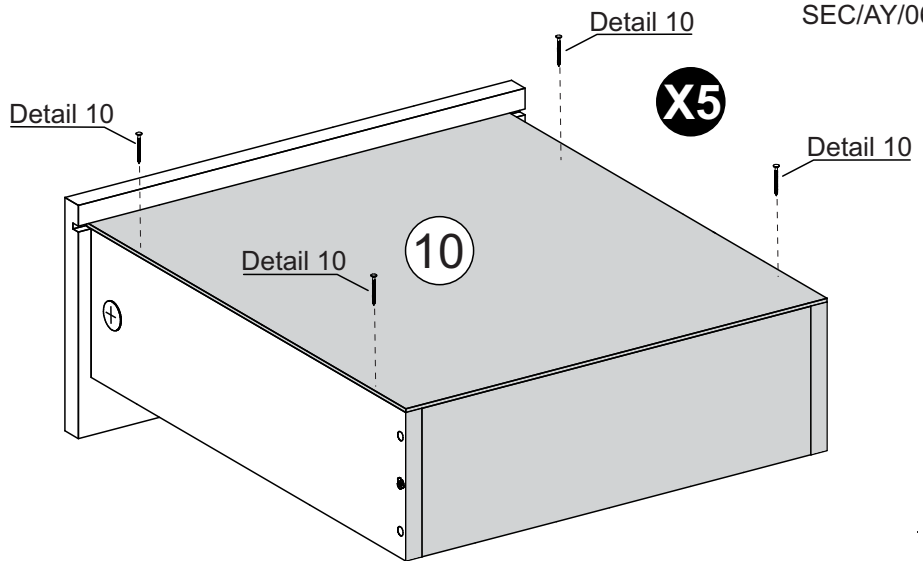
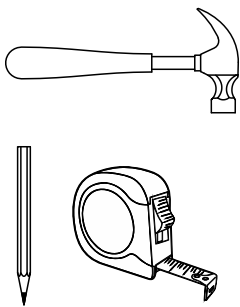

STEP 16

PARTS REQUIRED

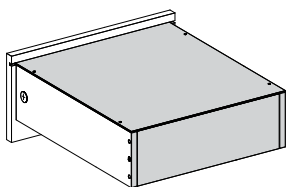

HARDWARE REQUIRED

F  20
10 x 10

TOOLS REQUIRED

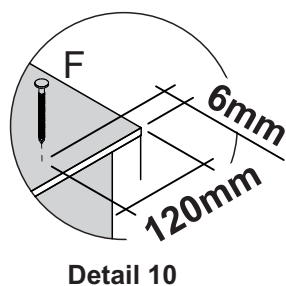
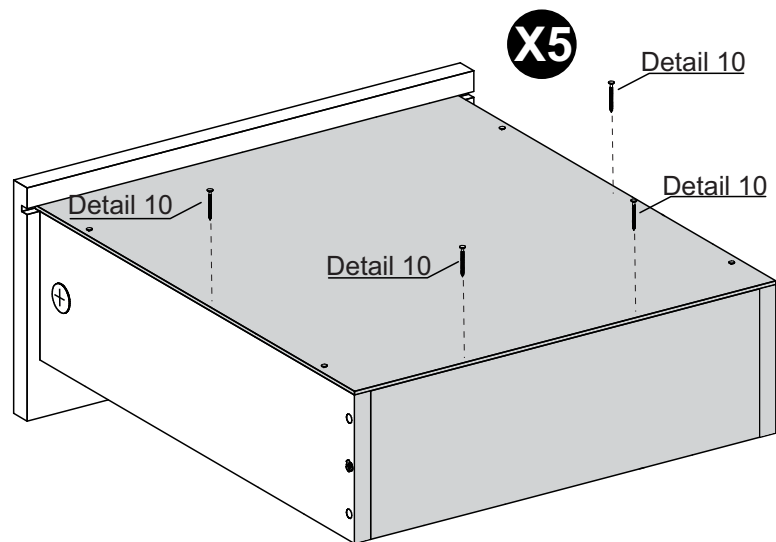
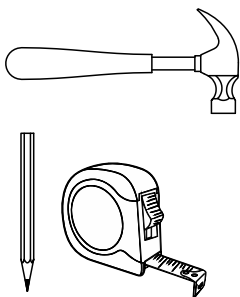

STEP 17

PARTS REQUIRED

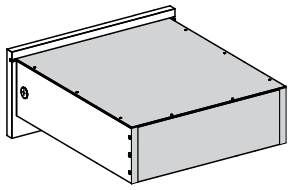

HARDWARE REQUIRED

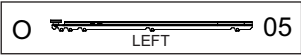
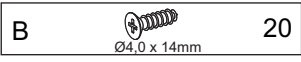

TOOLS REQUIRED

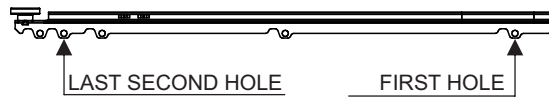
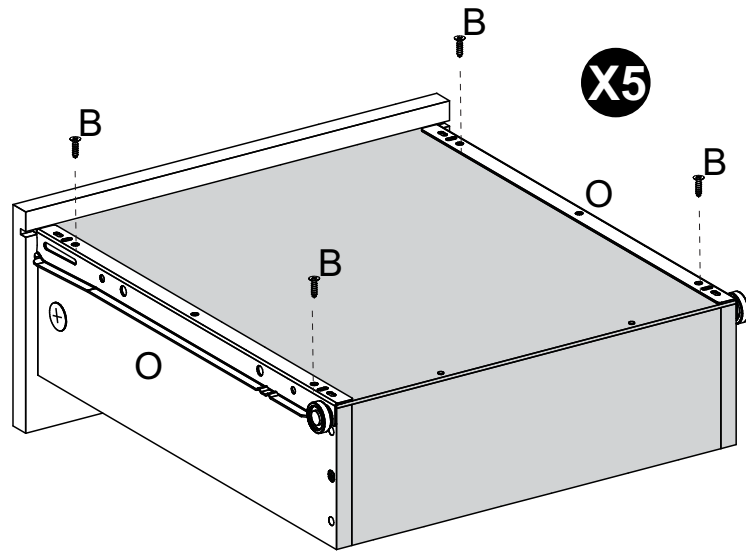
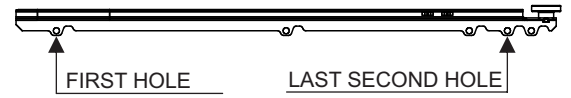
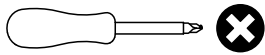

STEP 18

PARTS REQUIRED

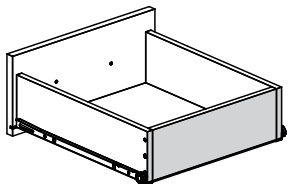

HARDWARE REQUIRED

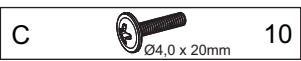

TOOLS REQUIRED

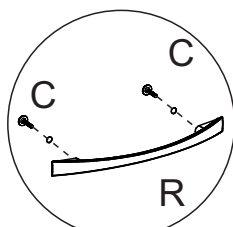
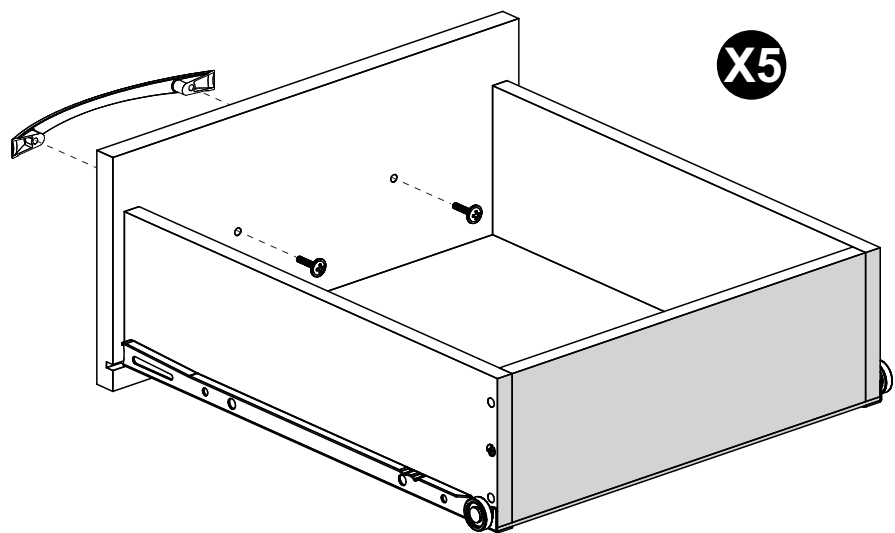
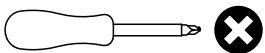

Detail 2

STEP 19

PARTS REQUIRED

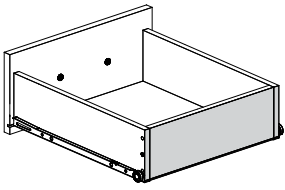

HARDWARE REQUIRED

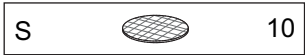

TOOLS REQUIRED

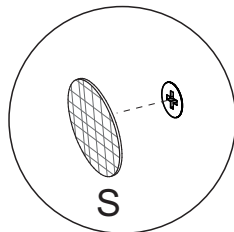
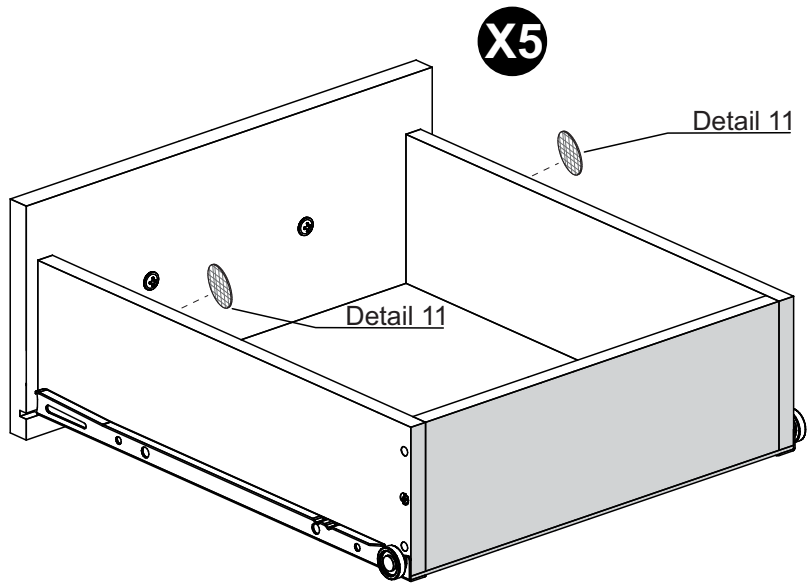

Detail 11

STEP 20

PARTS REQUIRED

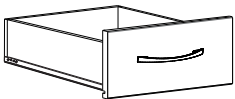
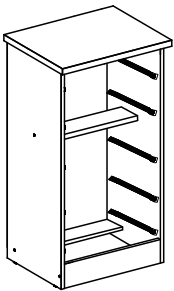

HARDWARE REQUIRED



TOOLS REQUIRED

 See the last page

TIP
If desired, after assembly use an alcohol cleaner to erase the number printed on the parts.



Detail 11

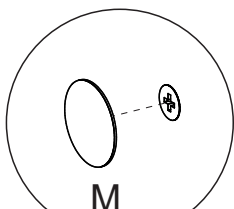

Detail 11

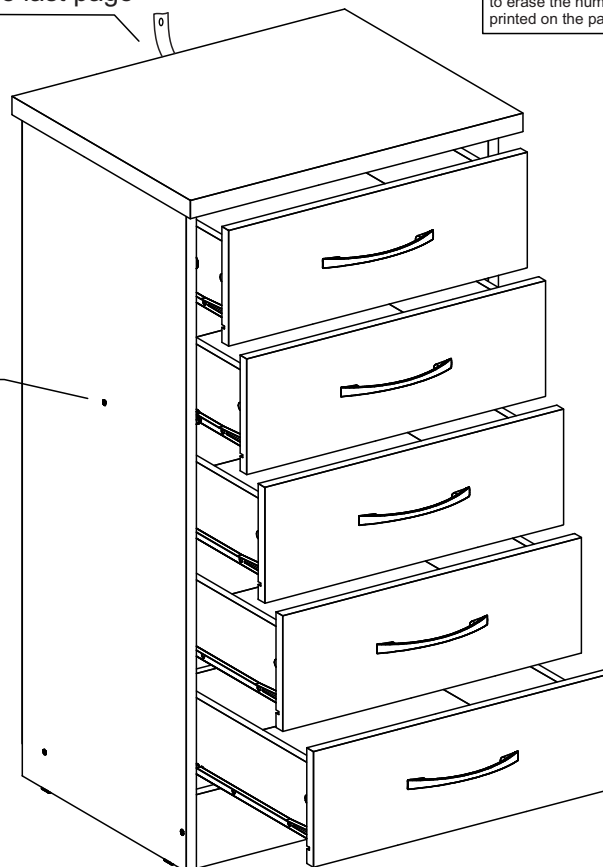

WARNING

Serious or fatal injuries can occur from furniture tipping over. To prevent the furniture from tipping over we recommend that it is permanently fixed to the wall.

Wall fixings are not supplied with this product as different wall materials require different types of fixing devices.

Please make sure you use fixings suitable for the walls in your home.

