

CLEVELAND 2 DOOR WARDROBE ASSEMBLY INSTRUCTIONS WHITE/GREY METAL EFFECT

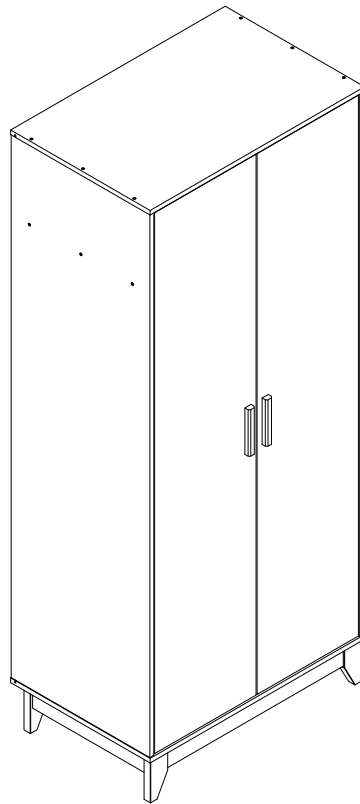

**IMPORTANT
FOR DOMESTIC USE ONLY**

PLEASE READ BEFORE YOU CONTINUE FURTHER

CARE AND MAINTENANCE

- After unpacking this product please keep the original packaging in case it needs to be returned for any reason.
- Please ensure all fittings and parts are present before commencing with assembly.
 - Never drag or push products as this could cause damage to the joints making it inferior.
 - We strongly recommend that you keep children away from your work area.
 - We recommend that you lay a blanket or sheet on the floor to avoid damage to both your floor and the product.
 - Assemble this product as close to its final position as possible.
 - Do not place this product next to a radiator or in direct sunlight.
 - Do not drag or push items across your high gloss furniture as this may cause the surface to scratch
 - Wood is a natural product and may expand if subjected to damp and may shrink or crack if subjected to heat. Therefore it is recommended that room temperature is maintained, with no sudden temperature fluctuations.
 - Make sure any spillage is wiped off immediately.
 - Do not place hot or chilled items directly on to the surface, use a place mat or marking will occur.
 - For general cleaning use a soft cotton or micro fibre cloth, and do not use detergents of any kind.
 - From time to time it may be necessary to tighten fittings, regular inspections should be carried out.
 - Do not place on a wet or damp floor as staining may occur to your floor.

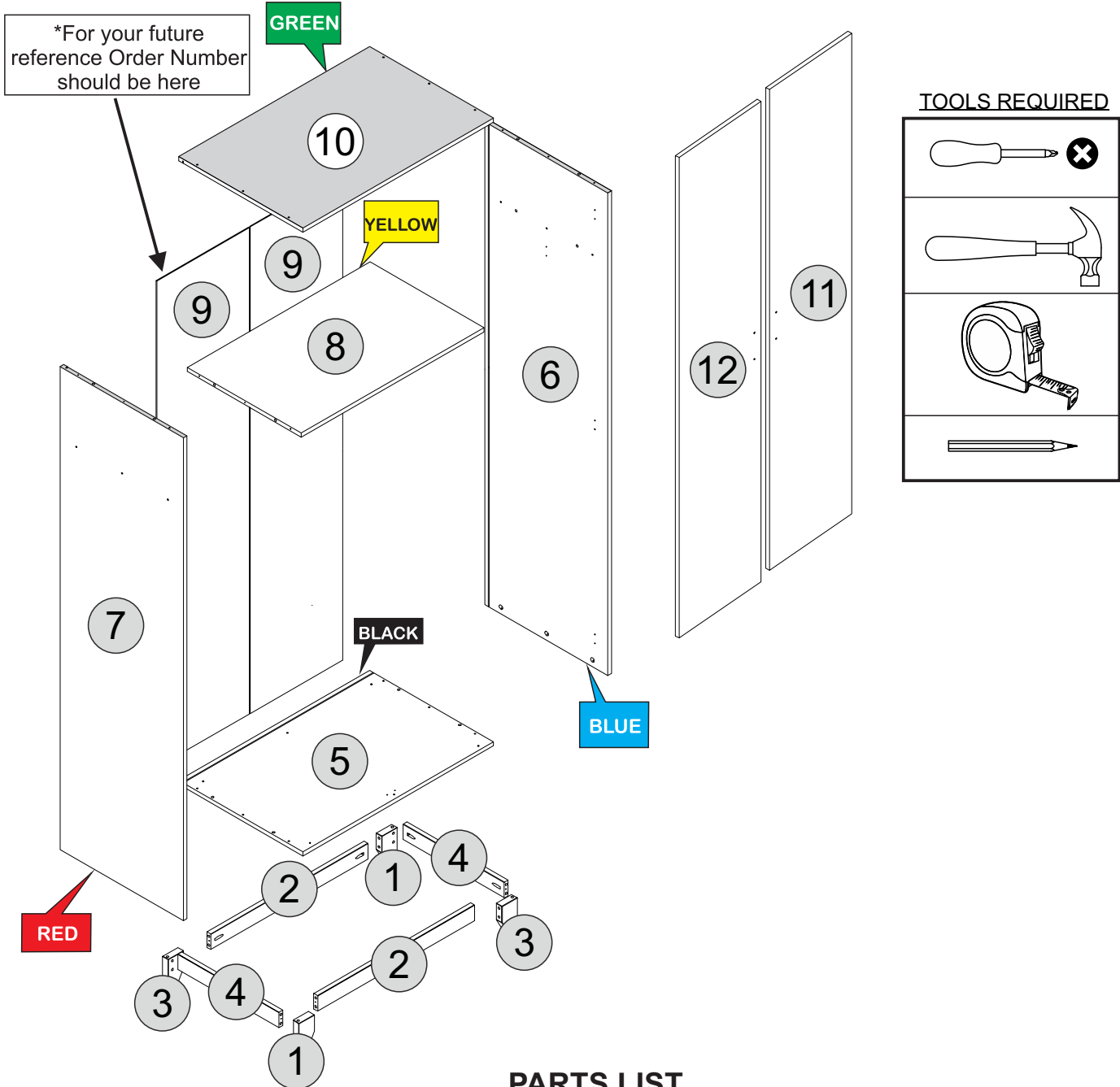









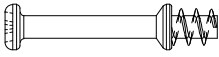
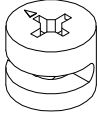
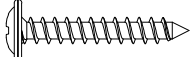
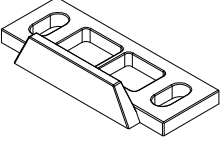
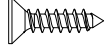
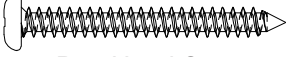

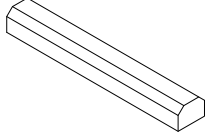
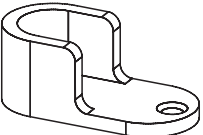
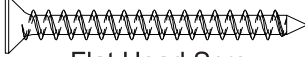
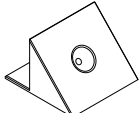
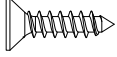
PARTS LIST

Please Note:
The below parts have all been stamped with the part number/color to help identify them during assembly.

Part Numer/Color	Part Code	Part Description	Quantity	Carton
1	S100-101-210-SP1-01	Left Leg	2	1/2
2	S100-101-210-SP1-02	Leg Support Front & Back	2	1/2
3	S100-101-210-SP1-03	Right Leg	2	1/2
4	S100-101-210-SP1-04	Leg Support Left & Right	2	1/2
5	S100-101-210-SP1-05	Base Panel - BLACK	1	1/2
6	S100-101-210-SP1-06	Right Side Panel - BLUE	1	1/2
7	S100-101-210-SP1-07	Left Side Panel - RED	1	1/2
8	S100-101-210-SP1-08	Shelf - YELLOW	1	1/2
9	S100-101-210-SP1-09	Back Panel	2	2/2
10	S100-101-210-SP1-10	Top Panel - GREEN	1	1/2
11	S100-101-210-SP1-11	Right Door	1	2/2
12	S100-101-210-SP1-12	Left Door	1	2/2

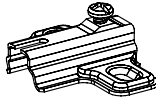
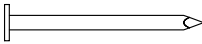
FITTINGS LIST

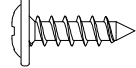
<p>A</p>  <p>Dowel Ø8,0 x 30mm (32x) 2/+</p>	<p>B</p>  <p>Cam Bolt (6x) 1/+</p>	<p>C</p>  <p>Cam Nut 15mm (6x) 1/+</p>	<p>D</p>  <p>Flan Head Screw Ø3,5 x 25mm (6x) 1/+</p>
<p>E</p>  <p>Door Stopper (2x)</p>	<p>F</p>  <p>Flat Head Screw Ø3,5 x 14mm (28x) 2/+</p>	<p>G</p>  <p>Pan Head Screw Ø4,0 x 35mm (8x) 1/+</p>	<p>H</p>  <p>Back Panel Strip 1753 mm (1x)</p>
<p>I</p>  <p>Handle (2x)</p>	<p>J</p>  <p>Hanging Rail Support (2x)</p>	<p>K</p>  <p>Flat Head Screw Ø4,0 x 50mm (18x) 2/+</p>	<p>L</p>  <p>Plastic Corner Bracket (18x) 2/+</p>
<p>M</p>  <p>Flat Head Screw Ø3,5 x 16mm (18x) 2/+</p>	<p>N</p>  <p>Hanging Rail (1x)</p>	<p>O</p>  <p>Washer (4x) 1/+</p>	<p>P</p>  <p>Hole Plugs (18x) 2/+</p>
<p>Q</p>  <p>Glue (3x)</p>	<p>R</p>  <p>Strap (2x)</p>	<p>S</p>  <p>Hinge Plate (6x)</p>	<p>T</p>  <p>Nail 10 x 10 (6x) 1/+</p>
<p>U</p>  <p>Hinge (6x)</p>	<p>V</p>  <p>Flan Head Screw Ø3,5 x 12mm (4x) 1/+</p>		

TIPS FOR FITTINGS CAM-LOCKS

WHEN FITTING CAM NUT, ENSURE STARTING POSITION IS CORRECT BEFORE YOU INSERT CONNECTING CAM BOLT TURN CLOCKWISE UNTIL SECURE

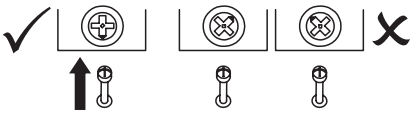

CORRECT **WRONG**

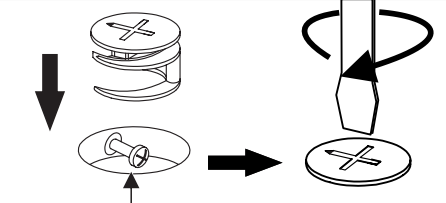

Cam bolt head needs to be in centre

CAMBOLT
Tighten until shoulder in flush with panel. Do not overtighten or undertighten (see example beside)

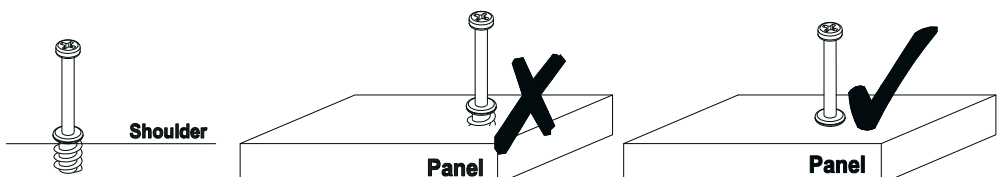



STEP 1

PARTS REQUIRED

1 - LEFT LEG	x2
3 - RIGHT LEG	x2

HARDWARE REQUIRED

A		20
Q		01

TOOLS REQUIRED

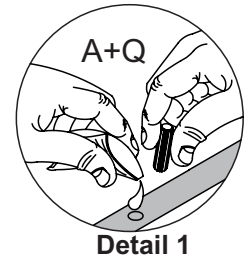
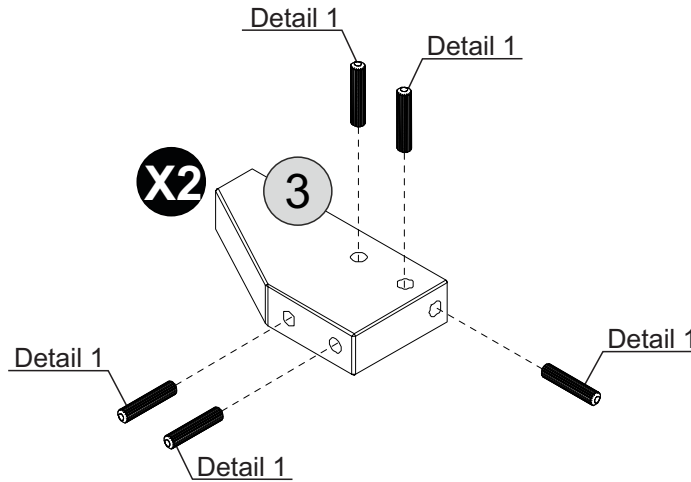
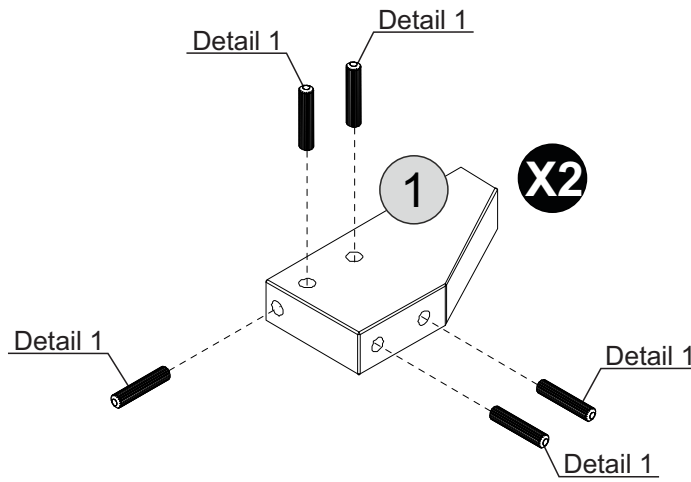
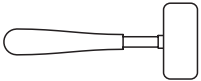



Detail 1

STEP 2

PARTS REQUIRED

1 - LEFT LEG	x2
2- LEG SUPPORT FRONT & BACK	x2
3 - RIGHT LEG	x2

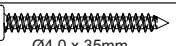
HARDWARE REQUIRED

G		04
Q		01

TOOLS REQUIRED

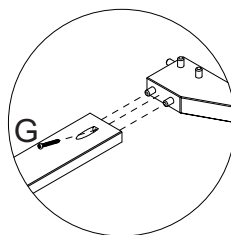
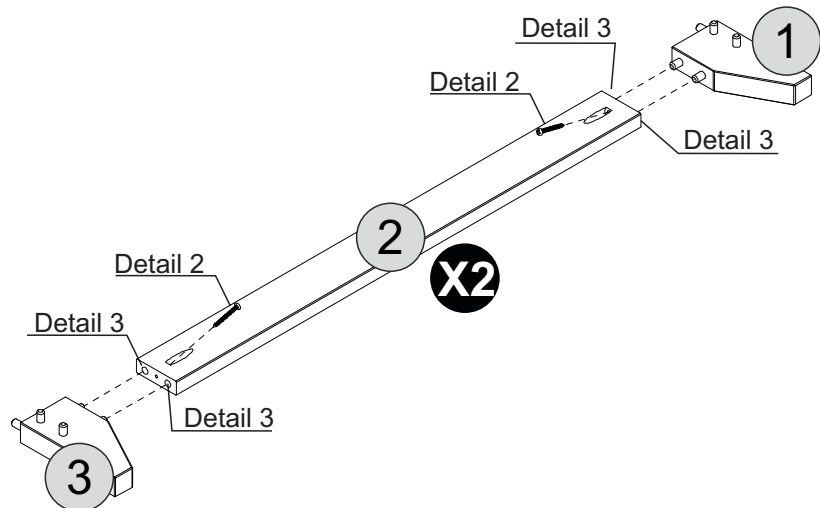

Detail 2

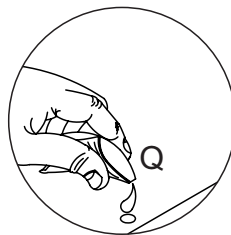

Detail 3

STEP 3

PARTS REQUIRED

4 - LEG SUPPORT LEFT & RIGHT x2

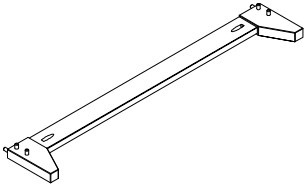

HARDWARE REQUIRED

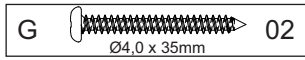

TOOLS REQUIRED

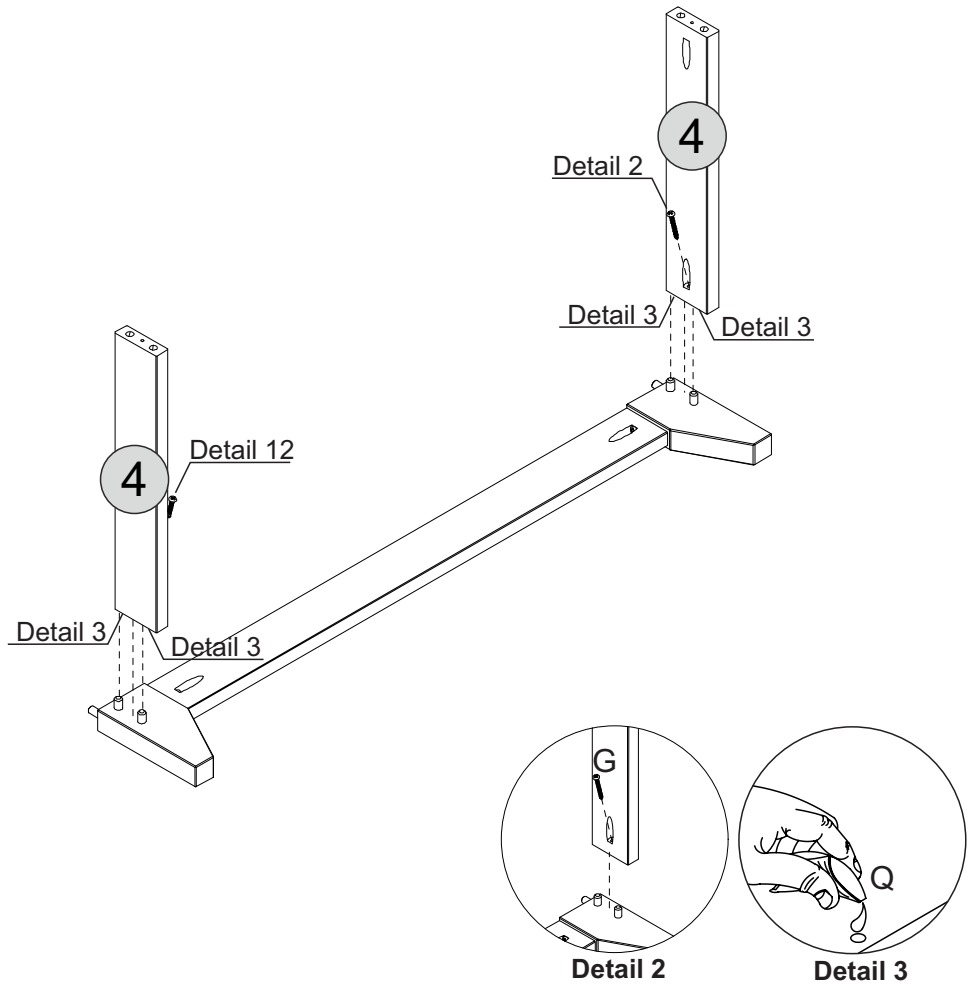
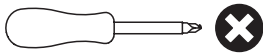

STEP 4

PARTS REQUIRED

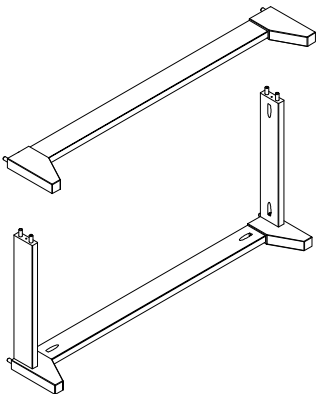

HARDWARE REQUIRED

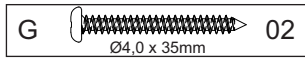

TOOLS REQUIRED

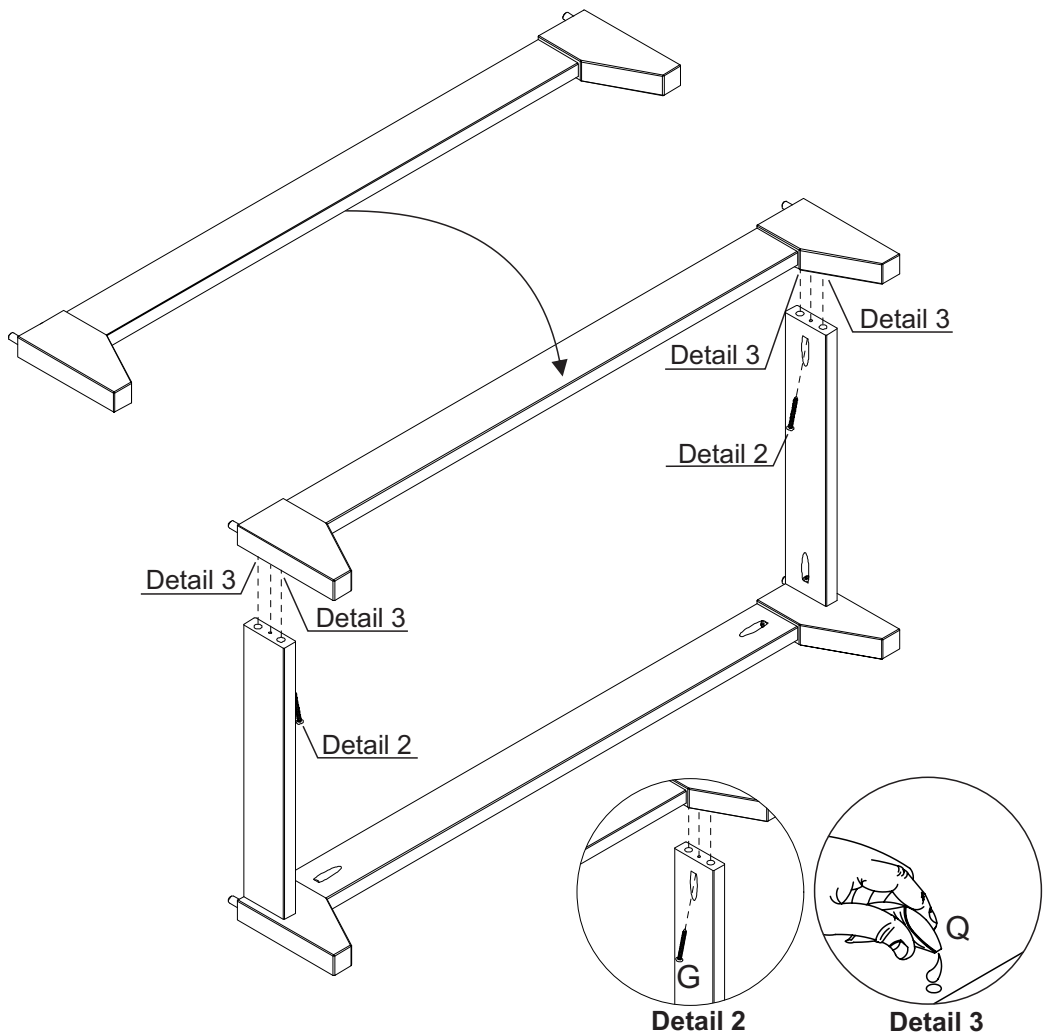

STEP 5

PARTS REQUIRED

7 - LEFT SIDE PANEL (RED) x1

HARDWARE REQUIRED

A  04
Ø8,0 x 30mm

Q  01
GLUE

TOOLS REQUIRED

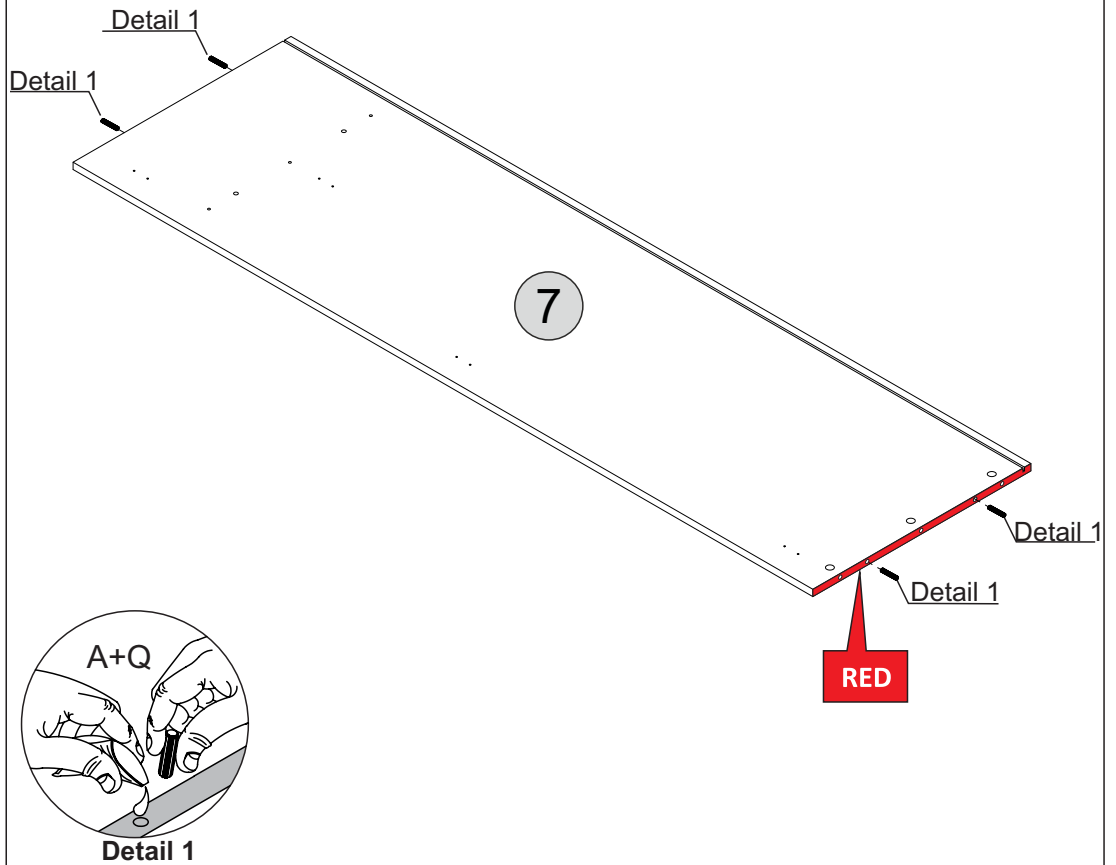
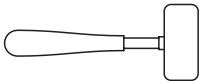

STEP 6

PARTS REQUIRED

7- LEFT SIDE PANEL (RED) x1

HARDWARE REQUIRED

F  08
Ø3,5x14mm

J  01

S  03

TOOLS REQUIRED

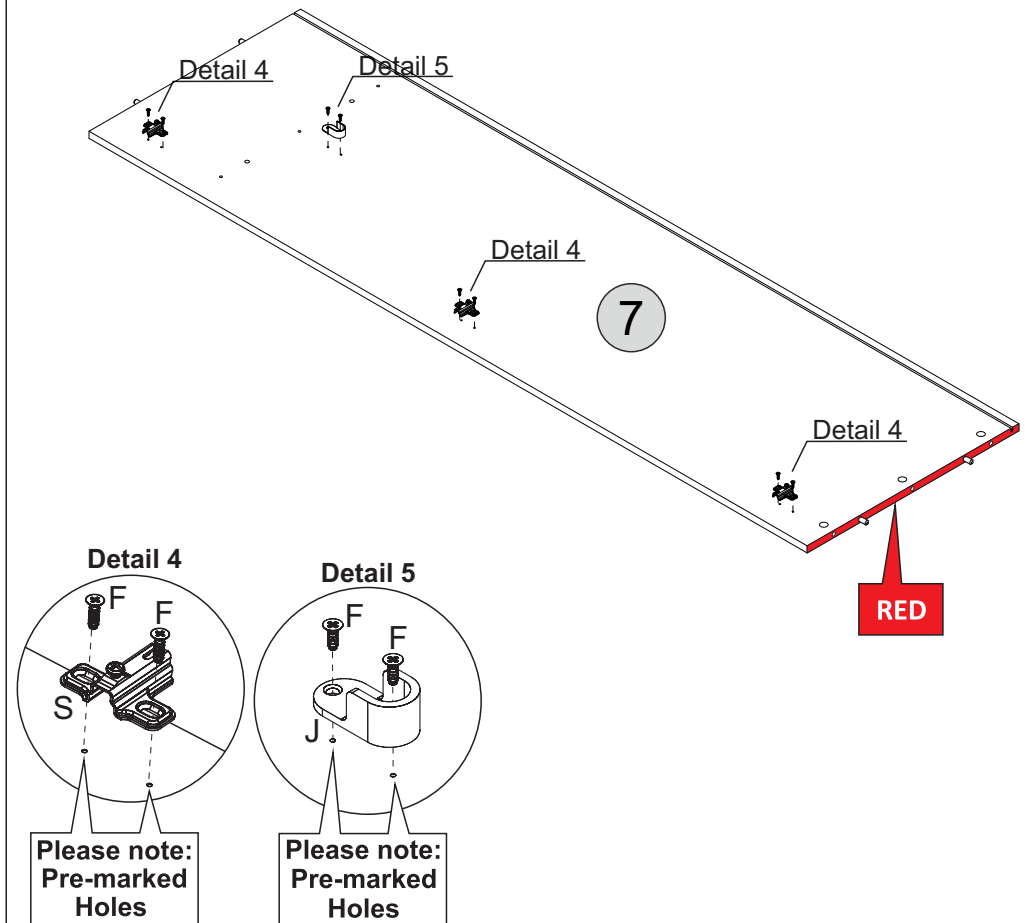

STEP 7

PARTS REQUIRED

6 - RIGHT SIDE PANEL (BLUE) x1

HARDWARE REQUIRED

A  04
Ø8,0 x 30mm

Q  01
GLUE

TOOLS REQUIRED

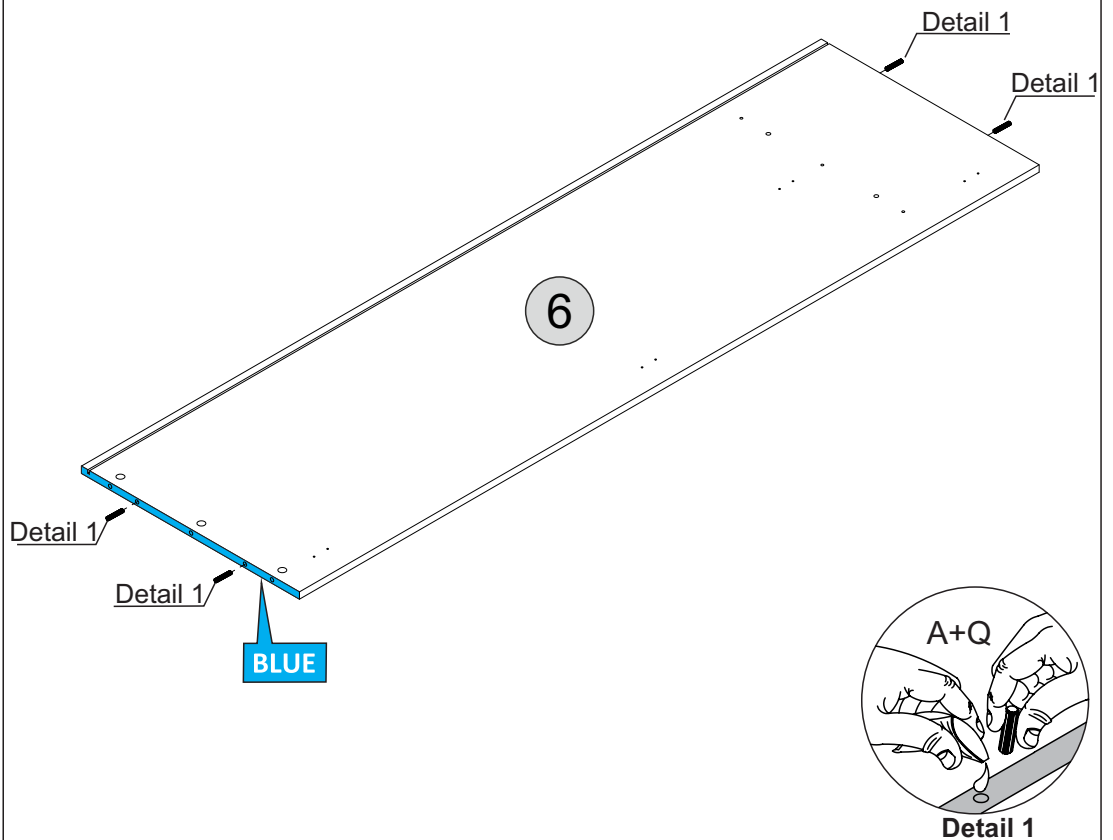
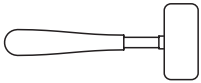

STEP 8

PARTS REQUIRED

6 - RIGHT SIDE PANEL (BLUE) x1

HARDWARE REQUIRED

F  08
Ø3.5x14mm

J  01

S  03

TOOLS REQUIRED

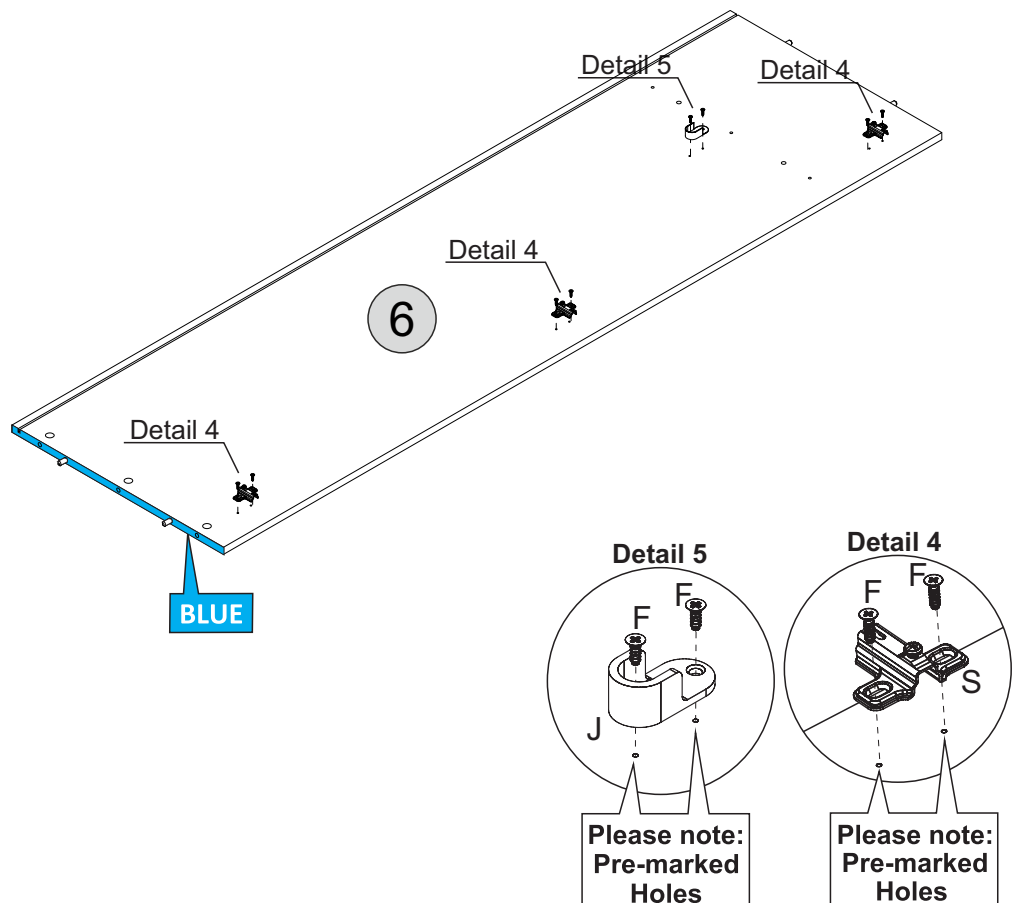
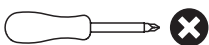

STEP 9

PARTS REQUIRED

8 - SHELF (YELLOW) x1

HARDWARE REQUIRED

A  04
Ø8,0 x 30mm

Q  01
GLUE

TOOLS REQUIRED

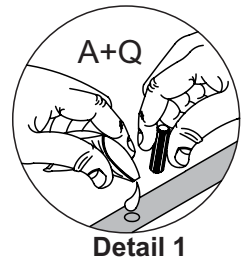
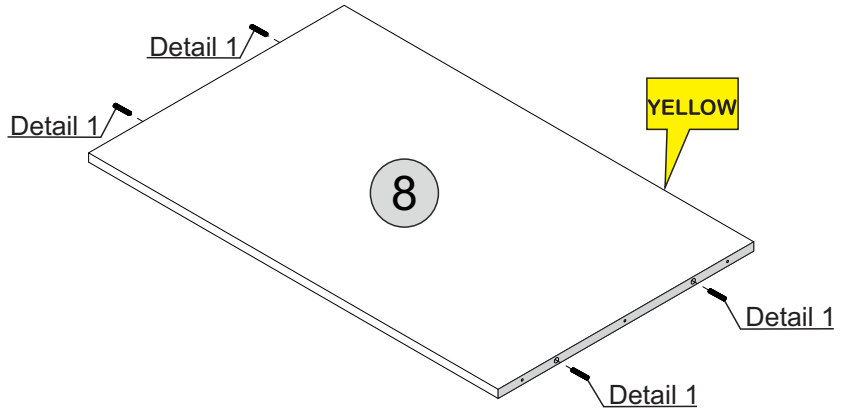
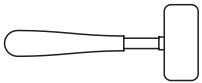

STEP 10

PARTS REQUIRED

5 - BASE PANEL (BLACK) x1

10 - TOP PANEL (GREEN) x1

HARDWARE REQUIRED

E  02

V  04
Ø3,5x12mm

TOOLS REQUIRED

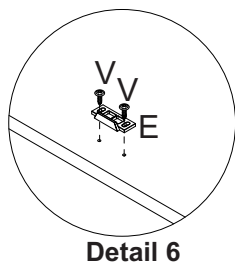
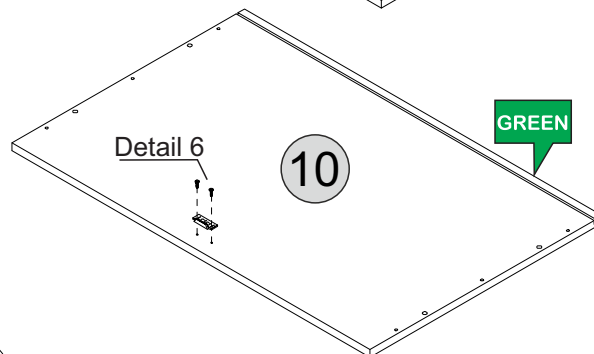
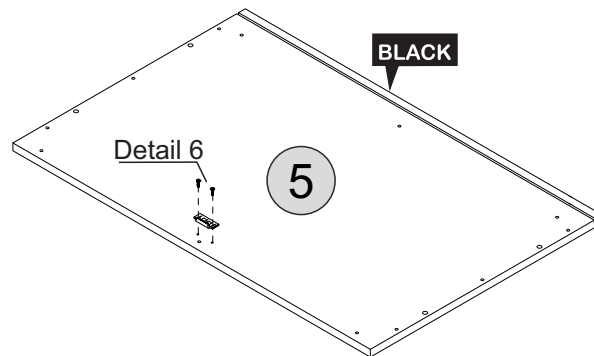

STEP 11

PARTS REQUIRED

5 - BASE PANEL (BLACK) x1

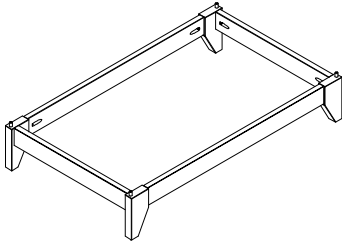

HARDWARE REQUIRED

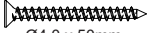
K  06
Ø4,0 x 50mm

P  06

Q  01

TOOLS REQUIRED

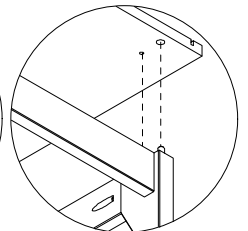
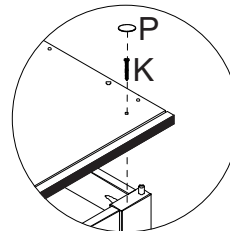
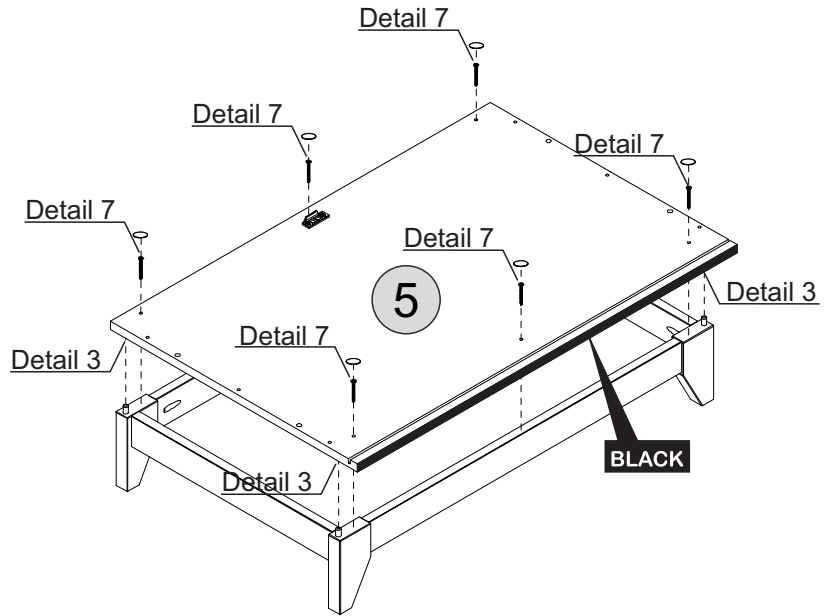
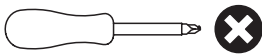

Detail 3

Detail 7

STEP 12

PARTS REQUIRED

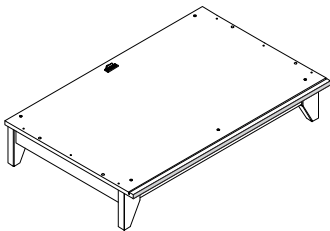

HARDWARE REQUIRED

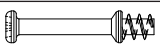
B  06

TOOLS REQUIRED

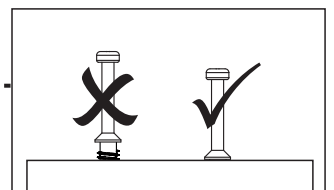
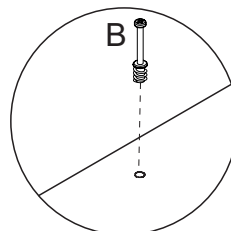
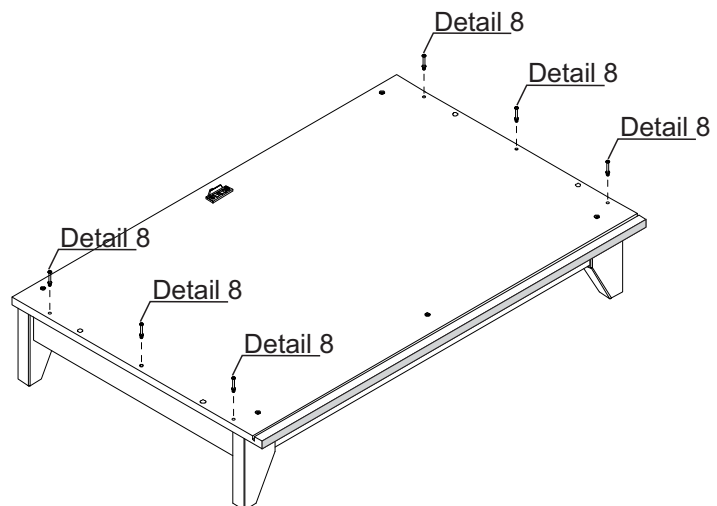

Detail 8

STEP 13

PARTS REQUIRED

6 - RIGHT SIDE PANEL (BLUE) x1

7 - LEFT SIDE PANEL (RED) x1

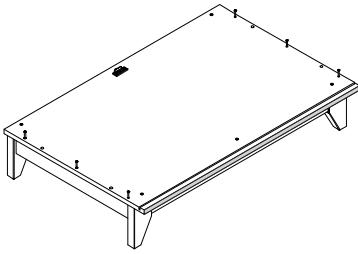

HARDWARE REQUIRED

C  Ø15mm 06

Q  GLUE 01

TOOLS REQUIRED

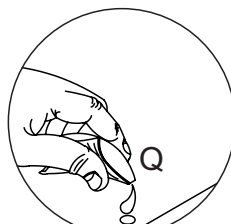
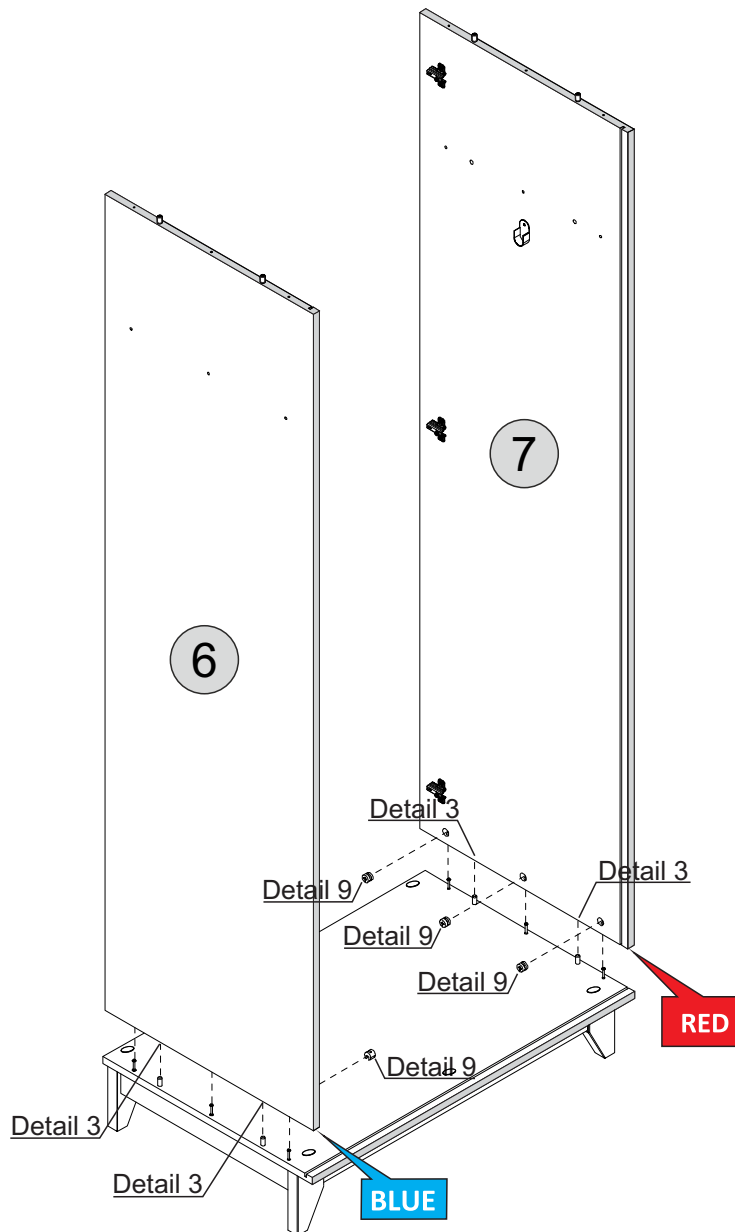
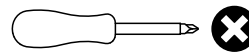

Detail 3

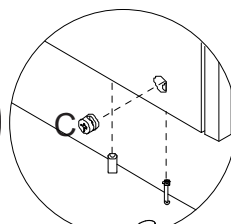

Detail 9

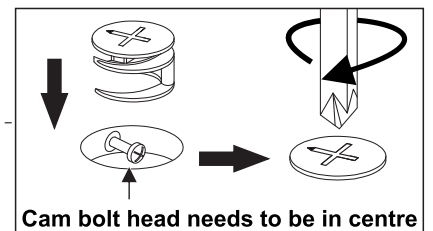

Cam bolt head needs to be in centre

STEP 14

PARTS REQUIRED

8 - SHELF (YELLOW) x1

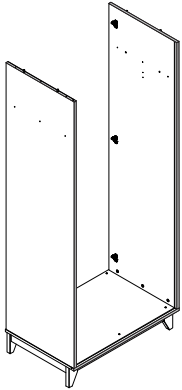

HARDWARE REQUIRED

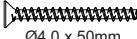
K  06
Ø4,0 x 50mm

Q  01
GLUE

TOOLS REQUIRED

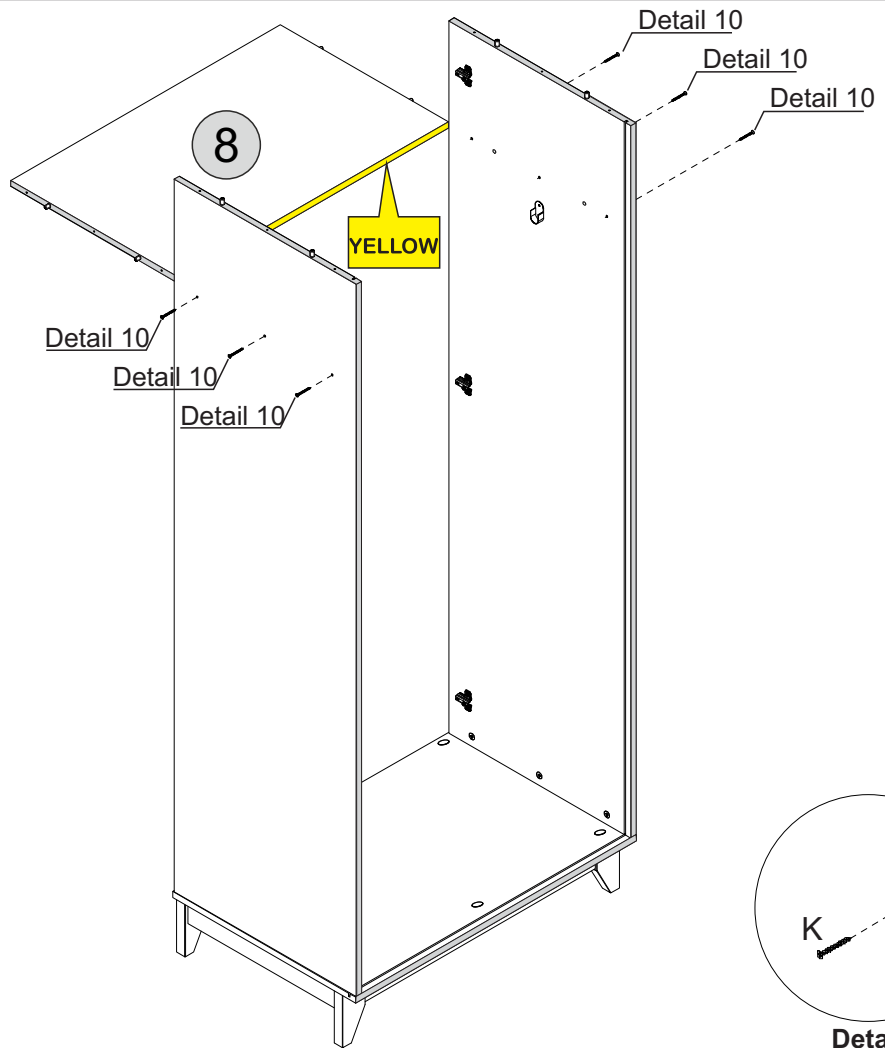
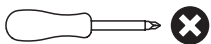

Detail 10

STEP 15

PARTS REQUIRED

9 - BACK PANEL x2

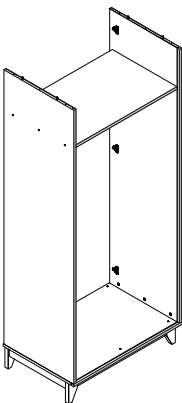

HARDWARE REQUIRED

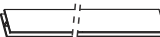
H  01

TOOLS REQUIRED

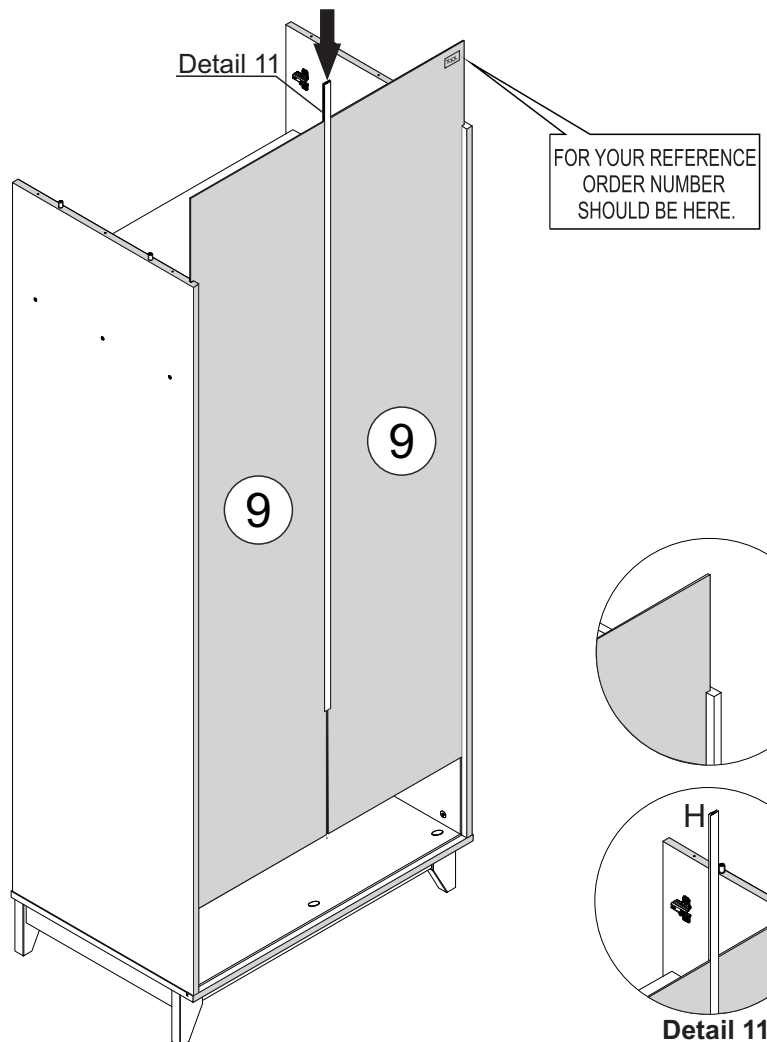

Detail 11

STEP 16

PARTS REQUIRED

10 - TOP PANEL (GREEN) x1

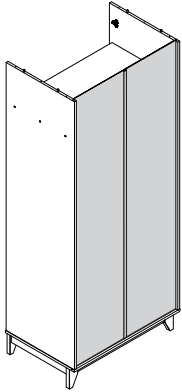

HARDWARE REQUIRED

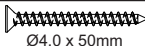
K  06
Ø4,0 x 50mm

Q  01
GLUE

TOOLS REQUIRED

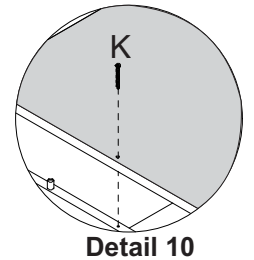
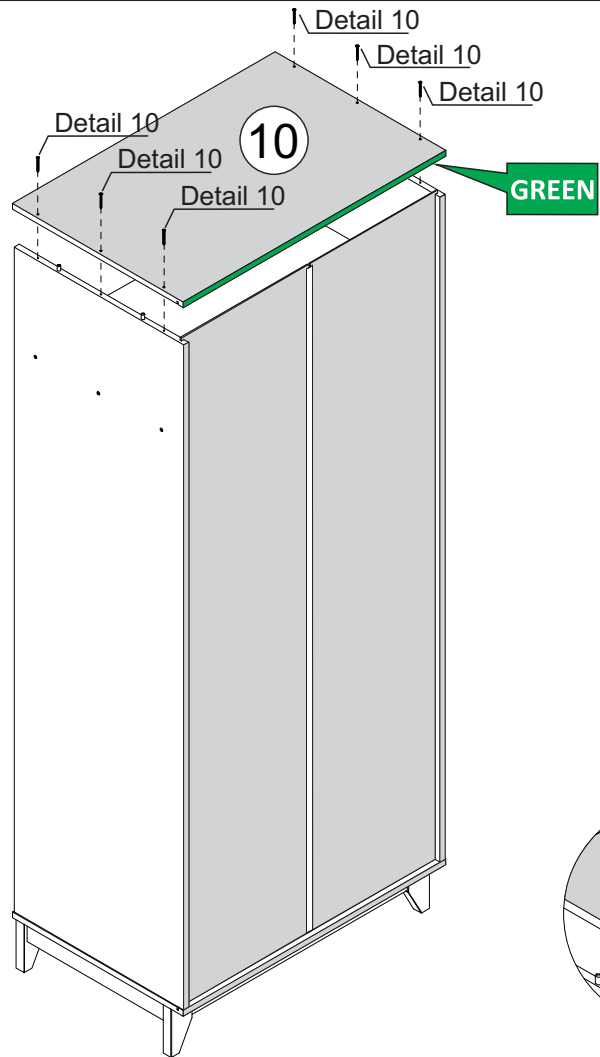

STEP 17

PARTS REQUIRED

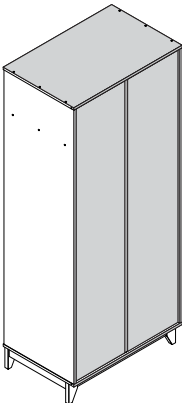

HARDWARE REQUIRED

L  18

M  18
Ø3,5 x 16mm

TOOLS REQUIRED

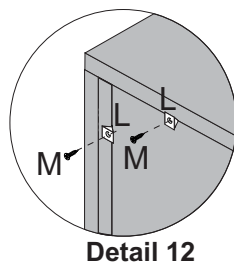
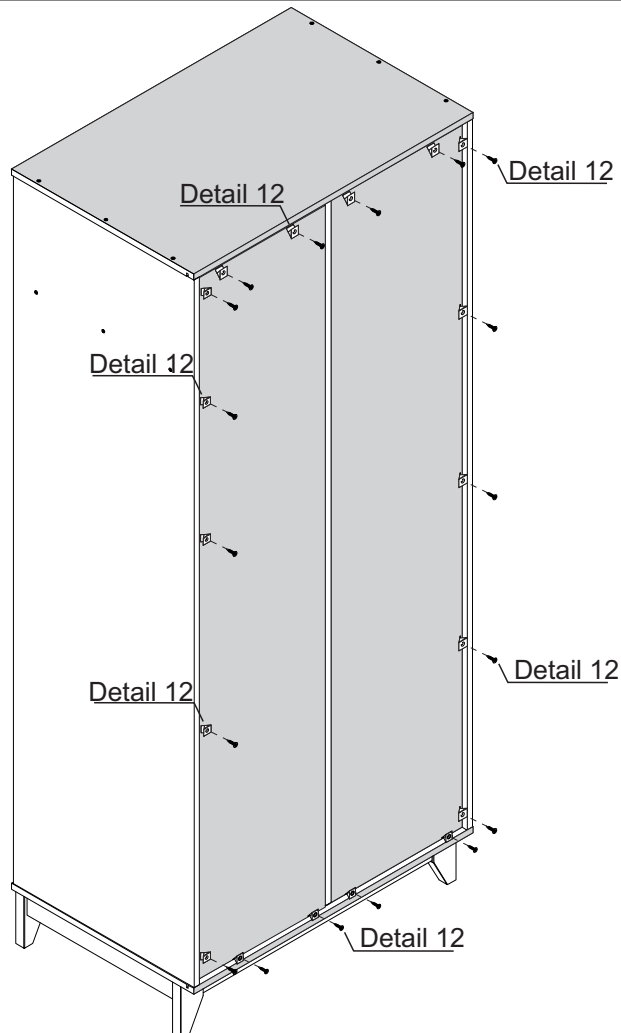
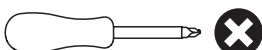

STEP 18

PARTS REQUIRED

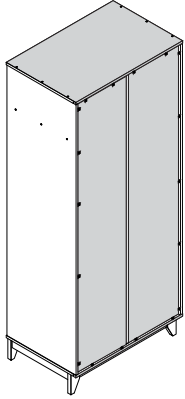

HARDWARE REQUIRED

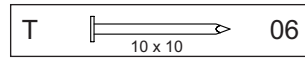

TOOLS REQUIRED

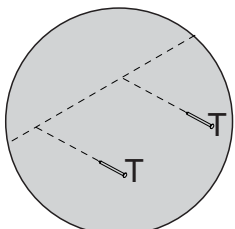
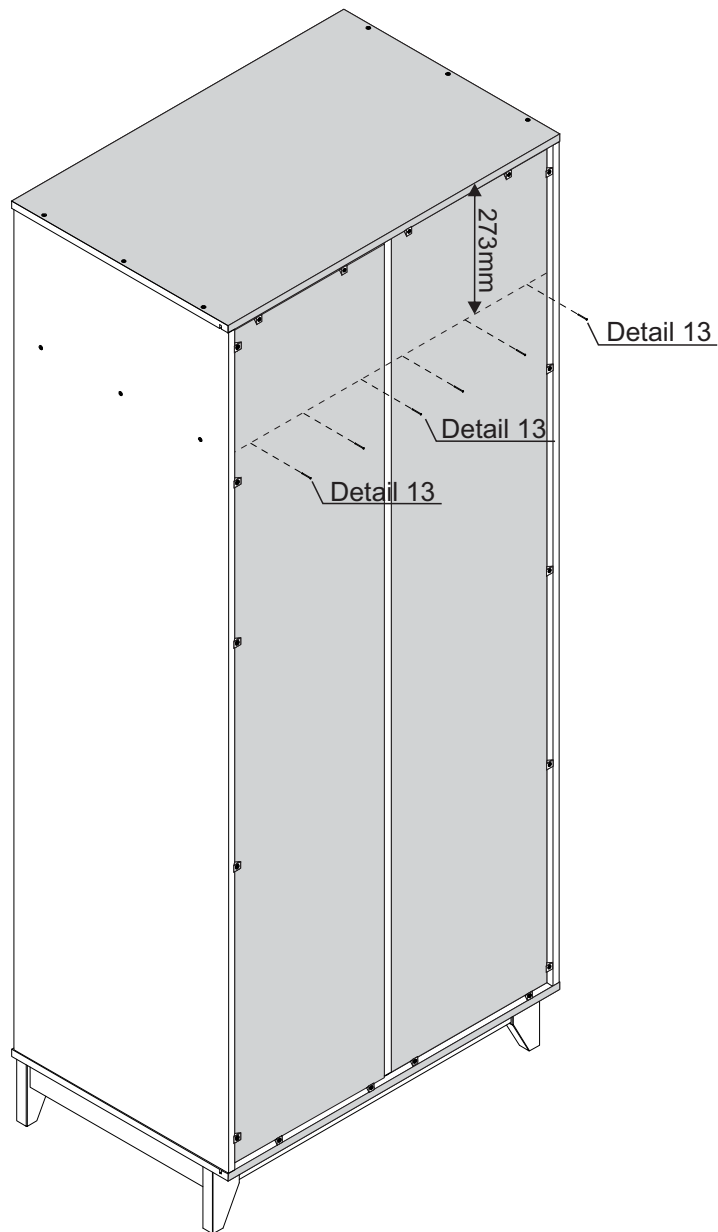
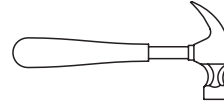

Detail 13

STEP 19

PARTS REQUIRED

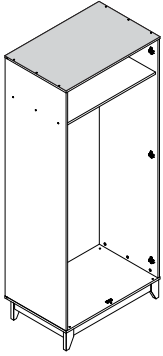

HARDWARE REQUIRED



TOOLS REQUIRED

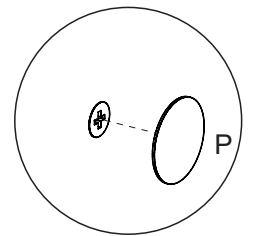
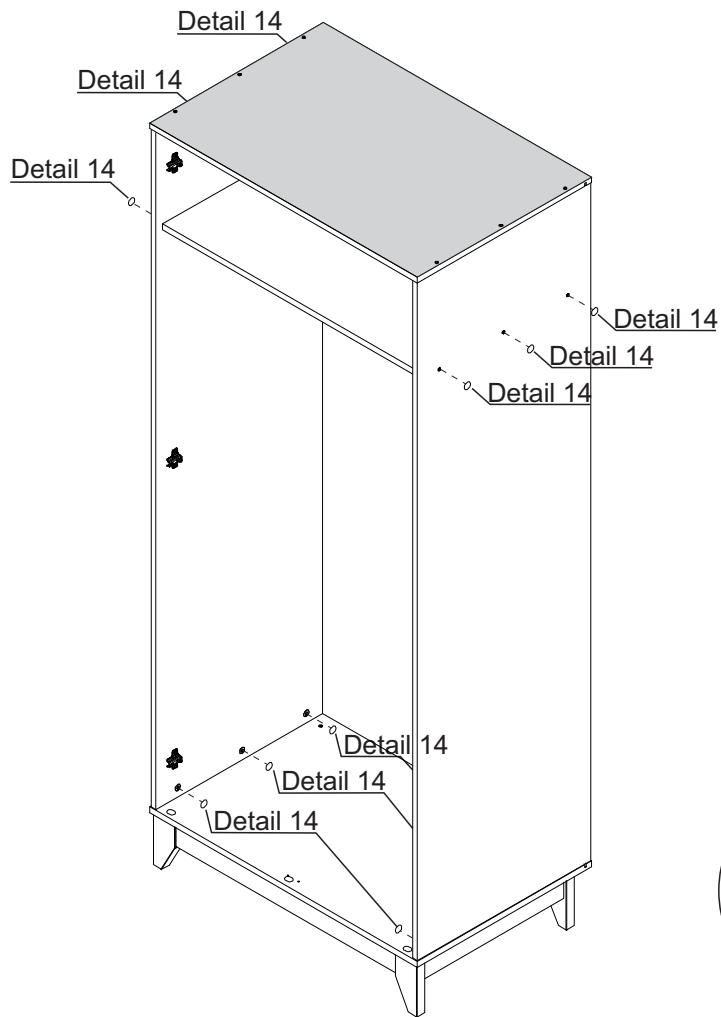
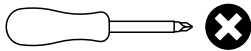

Detail 14

STEP 20

PARTS REQUIRED

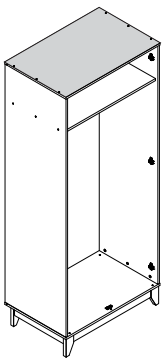

HARDWARE REQUIRED

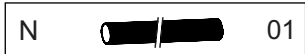

TOOLS REQUIRED

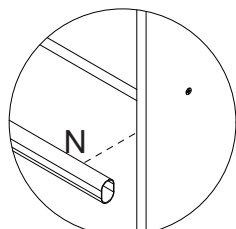
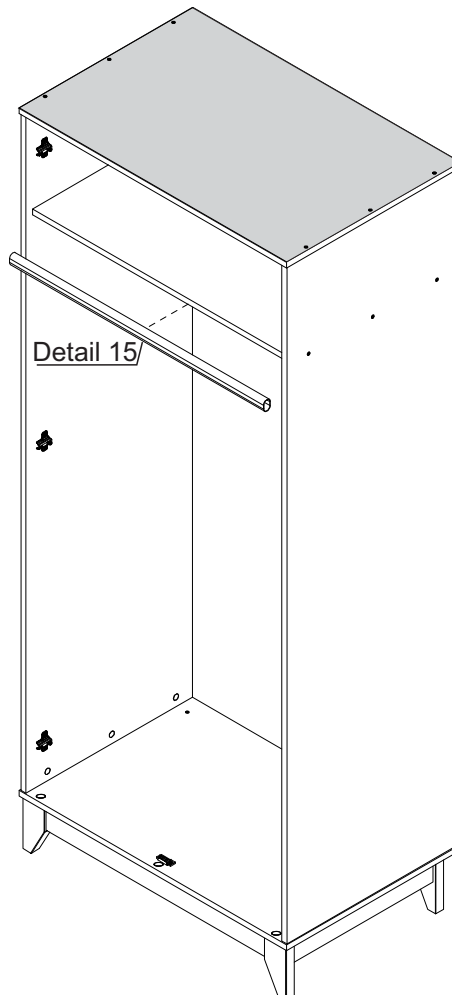



Detail 15

STEP 21

PARTS REQUIRED

11 - RIGHT DOOR	x1
12 - LEFT DOOR	x1

HARDWARE REQUIRED

F	 Ø3,5x14mm	12
U		06

TOOLS REQUIRED

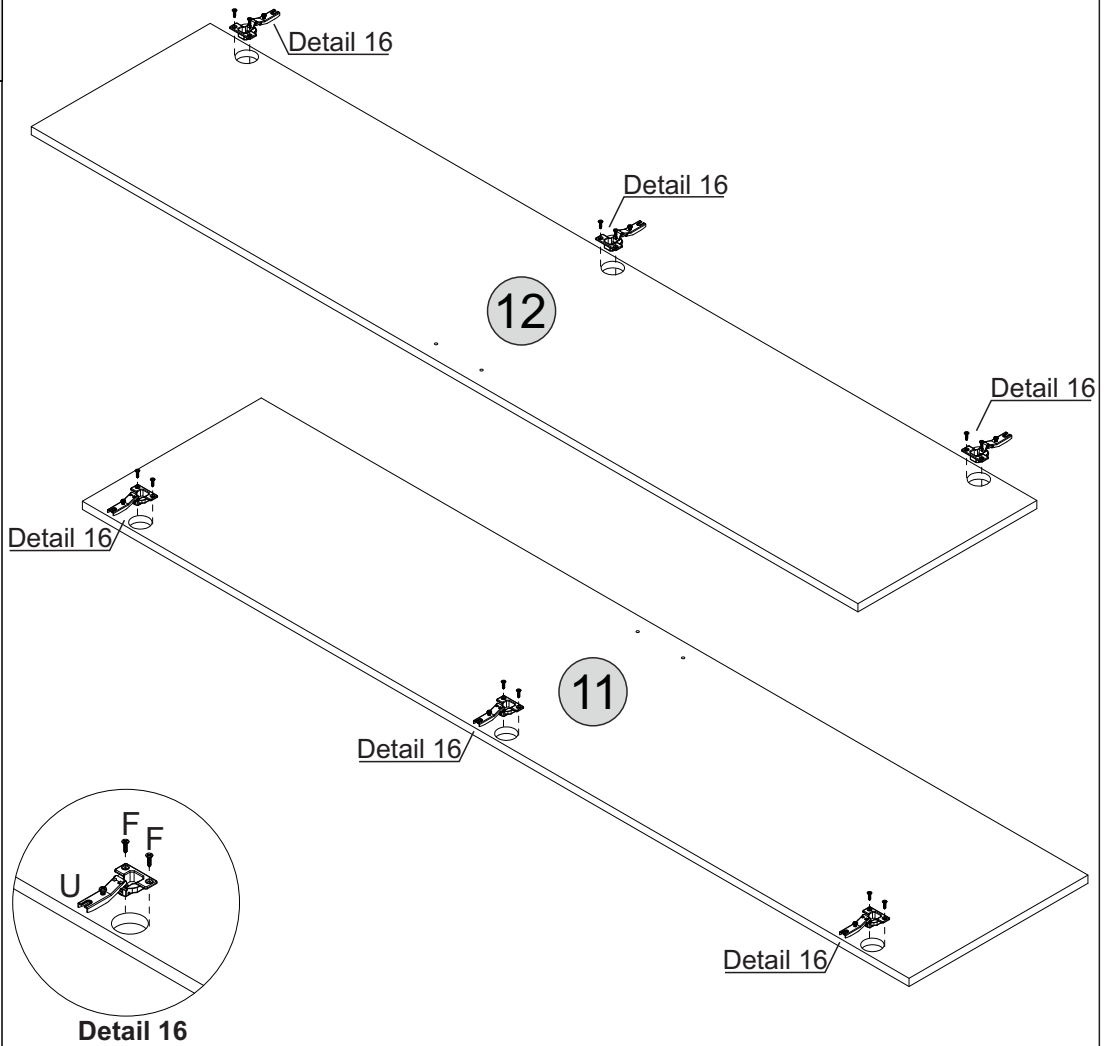
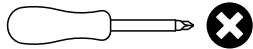



STEP 22

PARTS REQUIRED

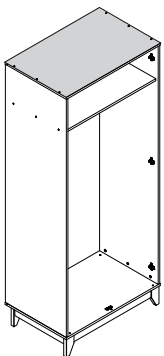
11 - RIGHT DOOR	x1
12 - LEFT DOOR	x1



HARDWARE REQUIRED

D	 Ø3,5 x 25mm	04
I		02

TOOLS REQUIRED

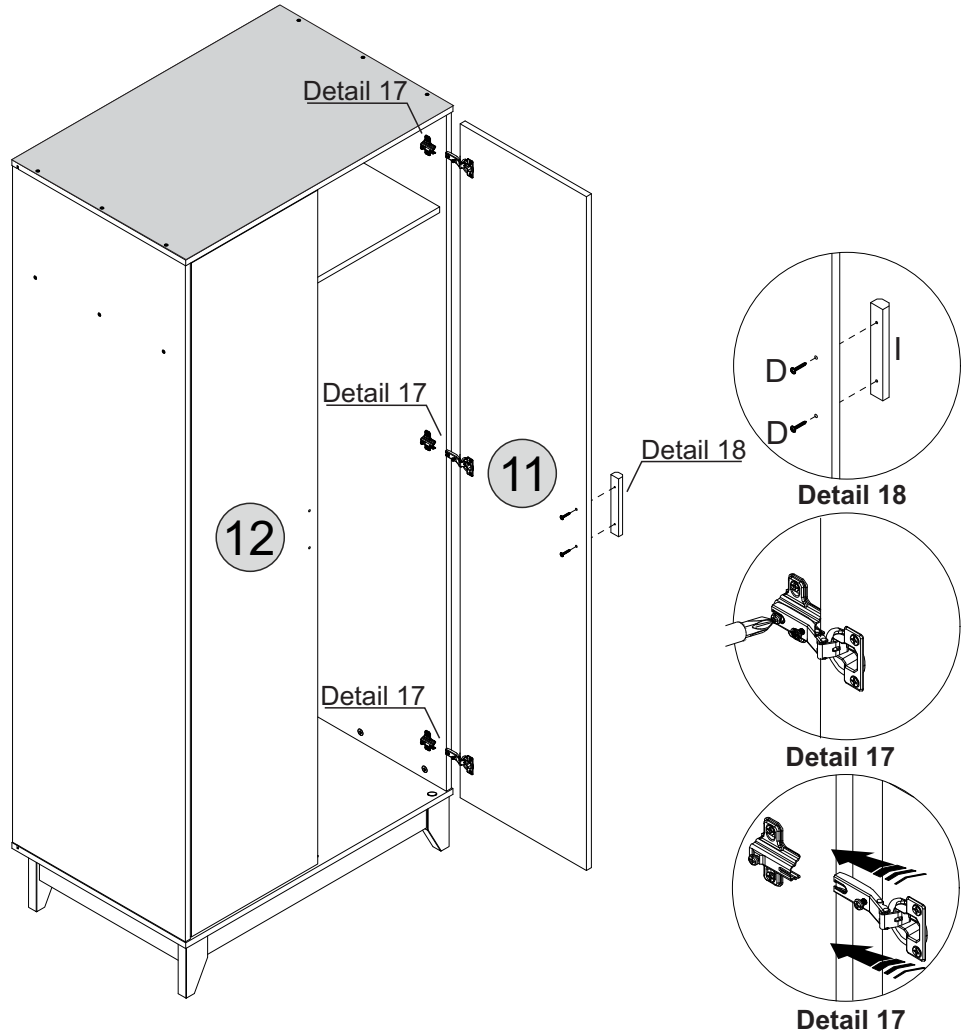
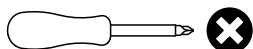

STEP 23

PARTS REQUIRED

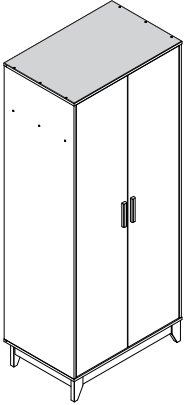

HARDWARE REQUIRED

D	 Ø3,5 x 25mm	02
---	--	----

O		04
---	---	----

R		02
---	---	----

TOOLS REQUIRED

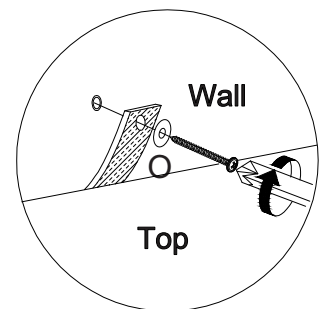
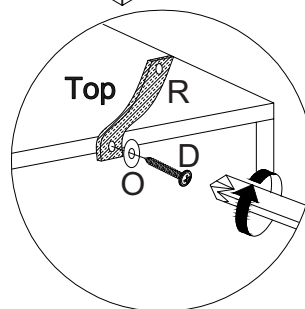
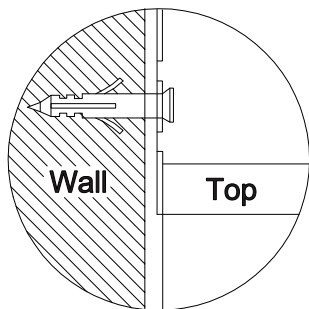
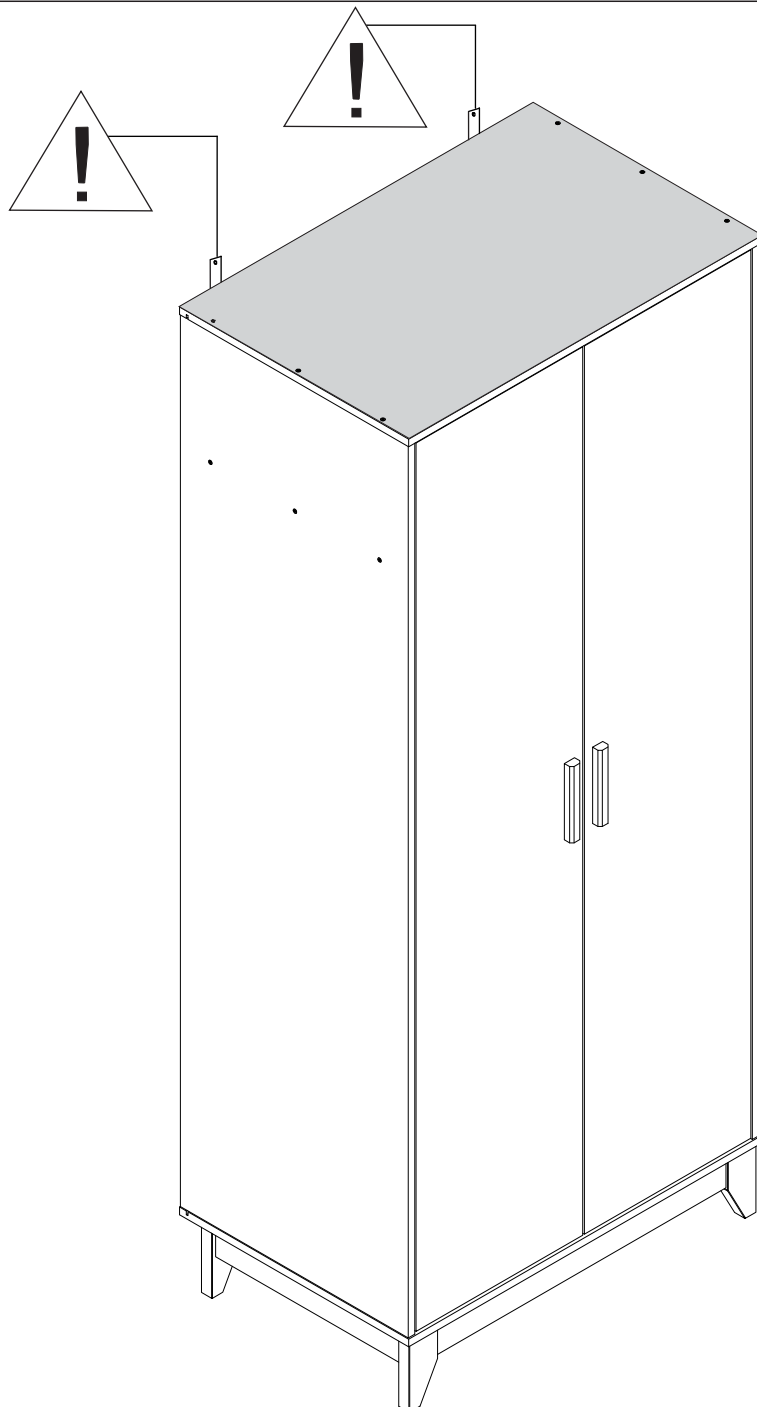
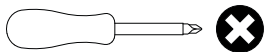

WARNING

Serious or fatal injuries can occur from furniture tipping over. To prevent the furniture from tipping over we recommend that it is permanently fixed to the wall.

Wall fixings are not supplied with this product as different wall materials require different types of fixing devices. Please make sure you use fixings suitable for the walls in your home.