

CODY 2 DOOR 1 DRAWER WARDROBE ASSEMBLY INSTRUCTIONS WHITE/PINE EFFECT

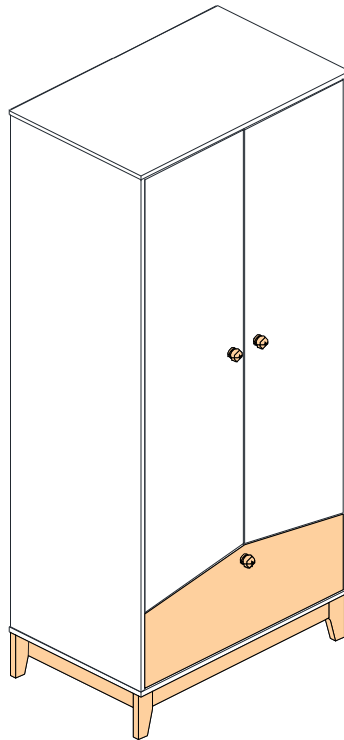

IMPORTANT FOR DOMESTIC USE ONLY

PLEASE READ BEFORE YOU CONTINUE FURTHER

CARE AND MAINTENANCE

After unpacking this product please keep the original packaging in case it needs to be returned for any reason.

- Please ensure all fittings and parts are present before commencing with assembly.
- Never drag or push products as this could cause damage to the joints making it inferior.
- We strongly recommend that you keep children away from your work area.
- We recommend that you lay a blanket or sheet on the floor to avoid damage to both your floor and the product.
- Assemble this product as close to its final position as possible.
- Do not place this product next to a radiator or in direct sunlight.
- Do not drag or push items across your high gloss furniture as this may cause the surface to scratch
- Wood is a natural product and may expand if subjected to damp and may shrink or crack if subjected to heat. Therefore it is recommended that room temperature is maintained, with no sudden temperature fluctuations.
- Make sure any spillage is wiped off immediately.
- Do not place hot or chilled items directly on to the surface, use a place mat or marking will occur.
- For general cleaning use a soft cotton or micro fibre cloth, and do not use detergents of any kind.
- From time to time it may be necessary to tighten fittings, regular inspections should be carried out.
- Do not place on a wet or damp floor as staining may occur to your floor.

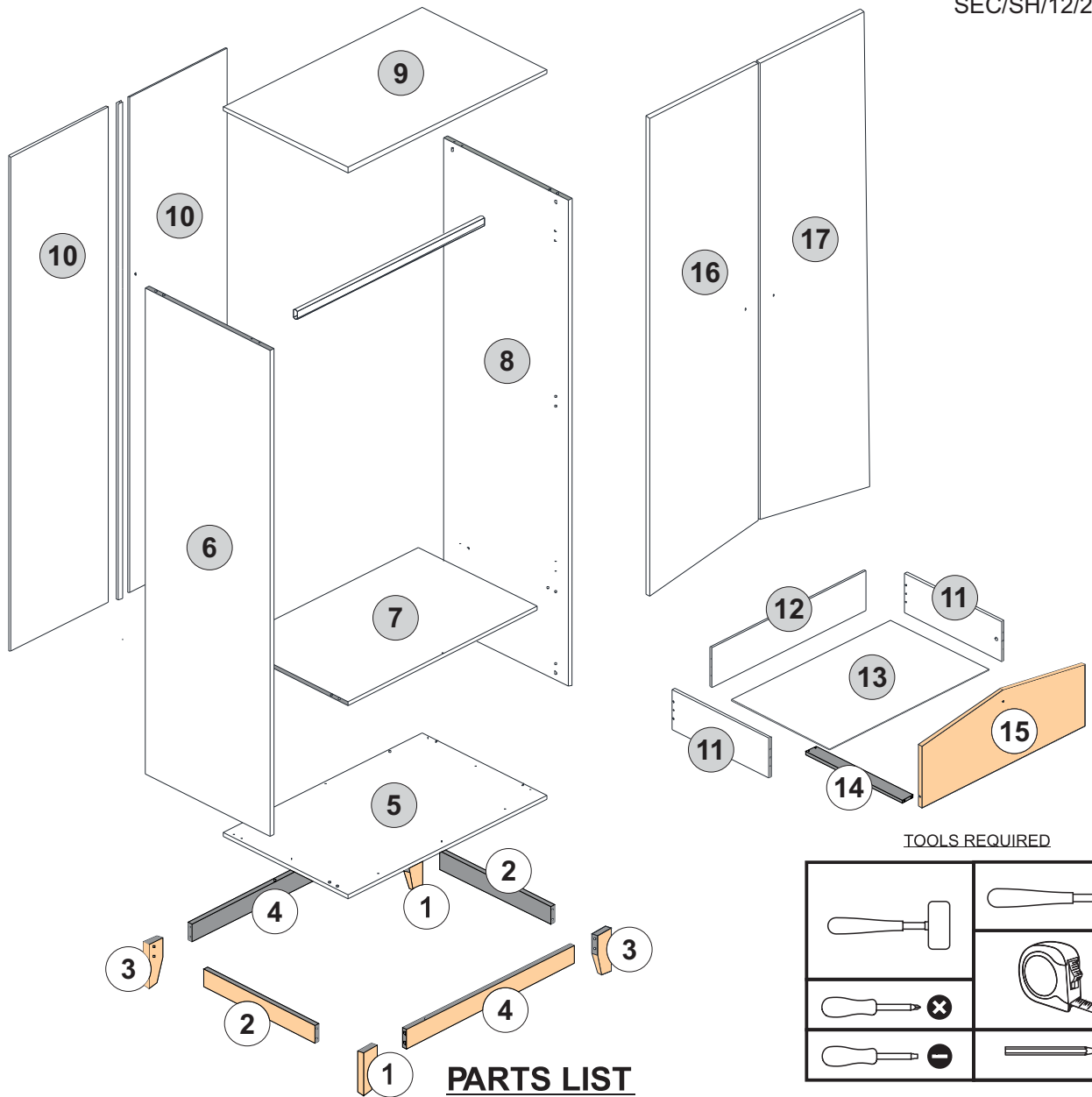













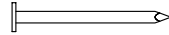

PARTS LIST

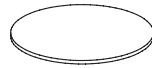
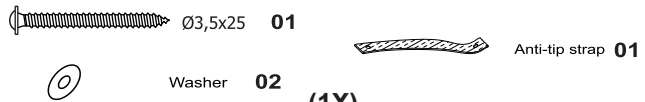
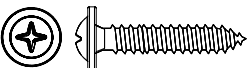
Please Note:
The below parts have all been stamped with the part number to help identify them during assembly.

Part Number	Part Code	Part Description	Quantity	Carton
1	S100-101-186-DV1-01	Left Leg	2	2/2
2	S100-101-186-DV1-02	Leg Support Left & Right	2	2/2
3	S100-101-186-DV1-03	Right Leg	2	2/2
4	S100-101-186-DV1-04	Leg Support Front & Back	2	2/2
5	S100-101-186-DV1-05	Base Panel	1	2/2
6	S100-101-186-DV1-06	Left Side Panel	1	1/2
7	S100-101-186-DV1-07	Shelf	1	2/2
8	S100-101-186-DV1-08	Right Side Panel	1	1/2
9	S100-101-186-DV1-09	Top Panel	1	2/2
10	S100-101-186-DV1-10	Back Panel	2	1/2
11	S100-101-186-DV1-11	Drawer Sides	2	2/2
12	S100-101-186-DV1-12	Drawer Back	1	2/2
13	S100-101-186-DV1-13	Drawer Base	1	2/2
14	S100-101-186-DV1-14	Drawer Base Support	1	2/2
15	S100-101-186-DV1-15	Drawer Front	1	2/2
16	S100-101-186-DV1-16	Left Door	1	1/2
17	S100-101-186-DV1-17	Right Door	1	1/2

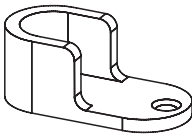
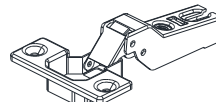
FITTINGS LIST

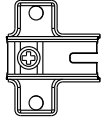
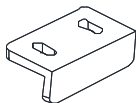
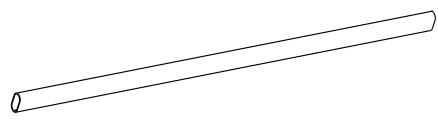
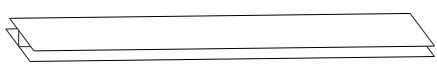
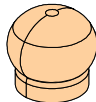
<p>A</p>  <p style="text-align: center;">Glue (3x)</p>	<p>B</p>  <p style="text-align: center;">2/+ Dowel Ø6,0 x 30mm (26x)</p>	<p>C</p>  <p style="text-align: center;">Slide 450mm (1x)</p>	<p>D</p>  <p style="text-align: center;">1/+ Flat Head Screw Ø4,0 x 40mm (8x)</p>
<p>E</p>  <p style="text-align: center;">5/+ Nail 10 x 10 (45x)</p>	<p>F</p>  <p style="text-align: center;">1/+ Cam Nut 12mm (6x)</p>	<p>G</p>  <p style="text-align: center;">1/+ Cam Bolt (22x)</p>	<p>H</p>  <p style="text-align: center;">1/+ Screw Ø 6x8 (4x)</p>
<p>I</p>  <p style="text-align: center;">1/+ Flat Head Screw Ø3,0 x 14mm (8x)</p>	<p>J</p>  <p style="text-align: center;">1/+ Hole Plugs (6x)</p>	<p>K</p>  <p style="text-align: center;">(1X)</p>	
<p>L</p>  <p style="text-align: center;">1/+ Flat Head Screw Ø4,0 x 30mm (3x)</p>	<p>M</p>  <p style="text-align: center;">2/+ Flat Head Screw Ø4,0 x 14mm (24x)</p>	<p>N</p>  <p style="text-align: center;">1/+ Dowel Ø8,0 x 30mm (8x)</p>	<p>O</p>  <p style="text-align: center;">1/+ Cam Nut 15mm (16x)</p>
<p>P</p>  <p style="text-align: center;">1/+ Flat Head Screw Ø3,5 x 25mm (2x)</p>	<p>Q</p>  <p style="text-align: center;">Hanging Rail Support (2x)</p>	<p>R</p>  <p style="text-align: center;">Hinge (6x)</p>	<p>S</p>  <p style="text-align: center;">1/+ Flat Head Screw Ø3,5 x 12mm (4x)</p>
<p>T</p>  <p style="text-align: center;">Hinge Plate (6x)</p>	<p>U</p>  <p style="text-align: center;">Door Stop (2x)</p>	<p>V</p>  <p style="text-align: center;">Hanging Rail 760mm (1x)</p>	
<p>W</p>  <p style="text-align: center;">Plastic profile 1596 mm (1x)</p>		<p>Y</p>  <p style="text-align: center;">Handle(3x)</p>	

TIPS FOR FITTINGS CAM-LOCKS

WHEN FITTING CAM NUT. ENSURE STARTING POSITION IS CORRECT BEFORE YOU INSERT CONNECTING CAM BOLT TURN CLOCKWISE UNTIL SECURE



↑

CORRECT



↑

WRONG

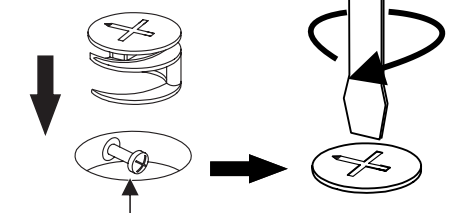

Cam bolt head needs to be in centre

CAMBOLT

Tighten until shoulder in flush with panel. Do not overtighten or undertighten (see example beside)



Shoulder

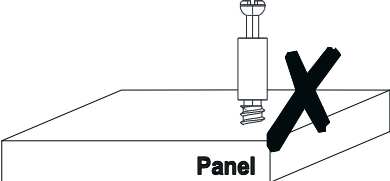

Panel

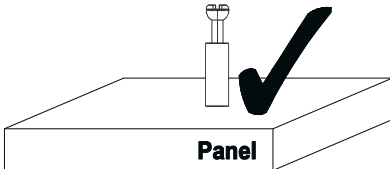

Panel

STEP 1

PARTS REQUIRED

1 - LEFT LEG x2

3 - RIGHT LEG x2

HARDWARE REQUIRED

G  08

TOOLS REQUIRED

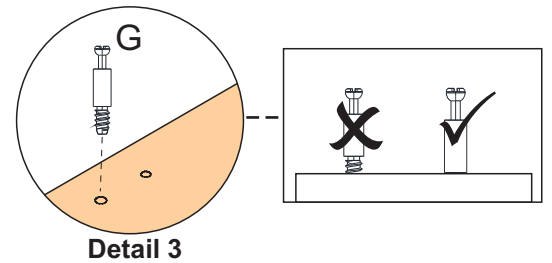
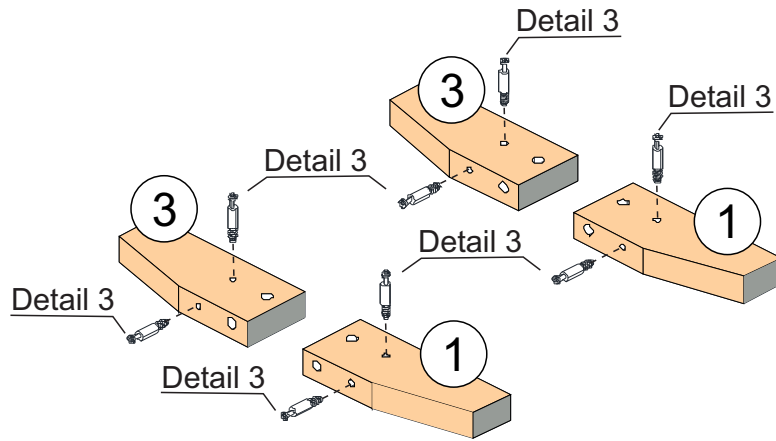
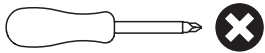

STEP 2

PARTS REQUIRED

2- LEG SUPPORT LEFT+RIGHT x2

4- LEG SUPPORT FRONT+BACK x2

HARDWARE REQUIRED

A  01

B  Ø6 x 30mm 04

N  Ø8 x 30mm 08

TOOLS REQUIRED

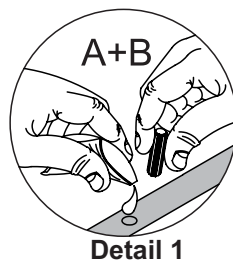
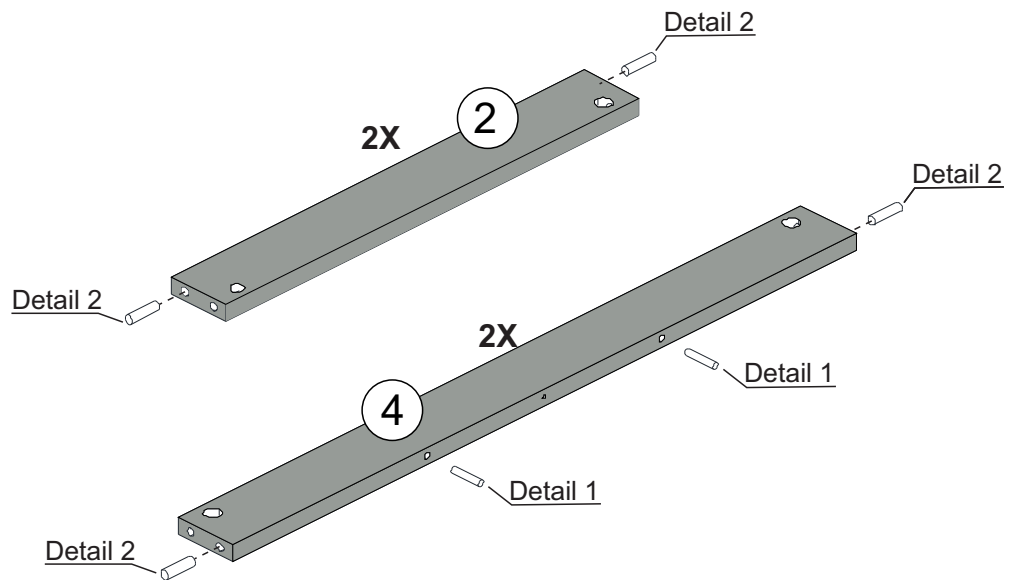
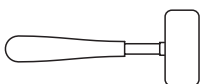

STEP 3

PARTS REQUIRED

7- SHELF x1

HARDWARE REQUIRED

A  01

B  04
Ø6 x 30mm

S  02
Ø3,5 x 12mm

U  01

TOOLS REQUIRED

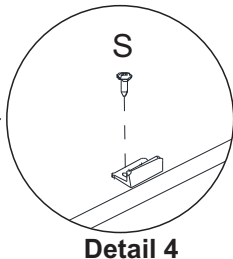
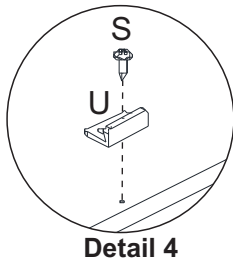
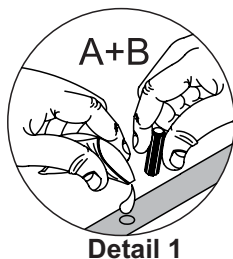
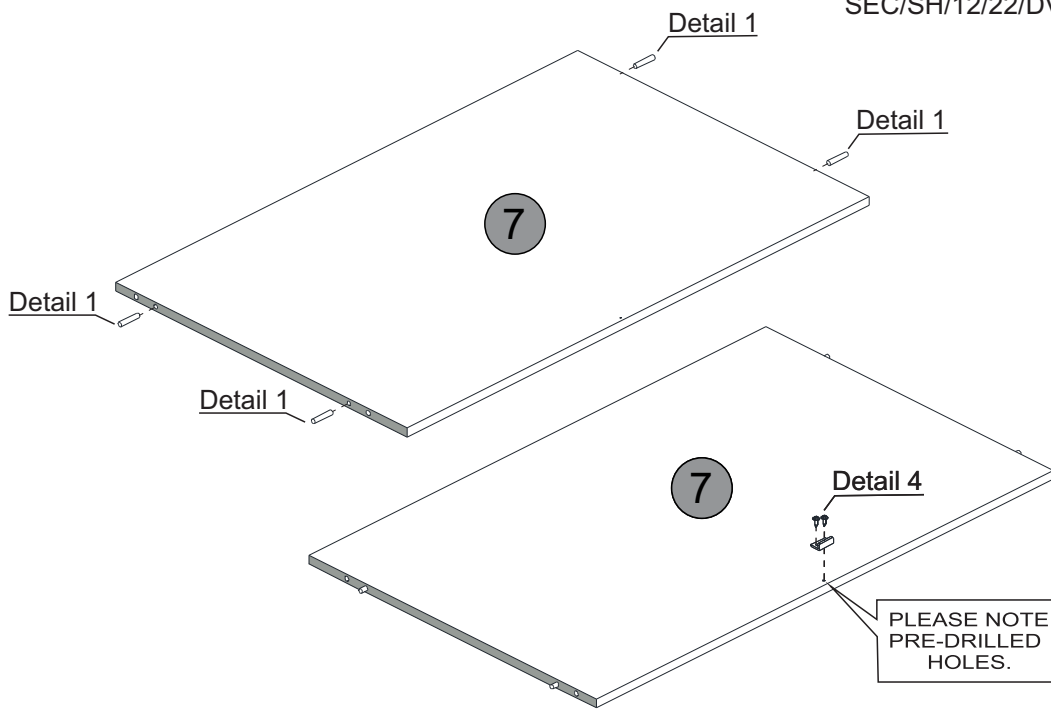
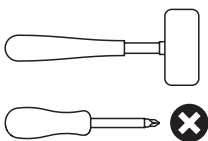



STEP 4

PARTS REQUIRED

9 - TOP PANEL x1

HARDWARE REQUIRED

G  04

S  02
Ø3,5 x 12mm

U  01

TOOLS REQUIRED

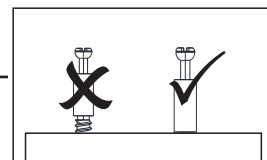
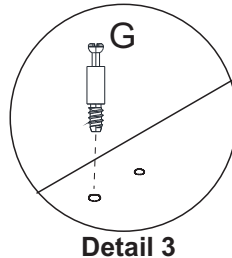
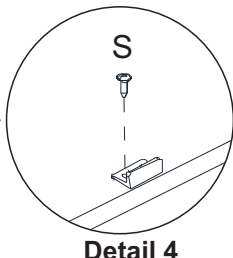
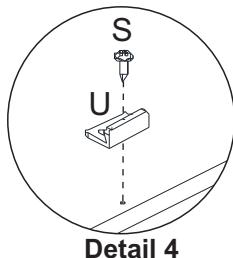
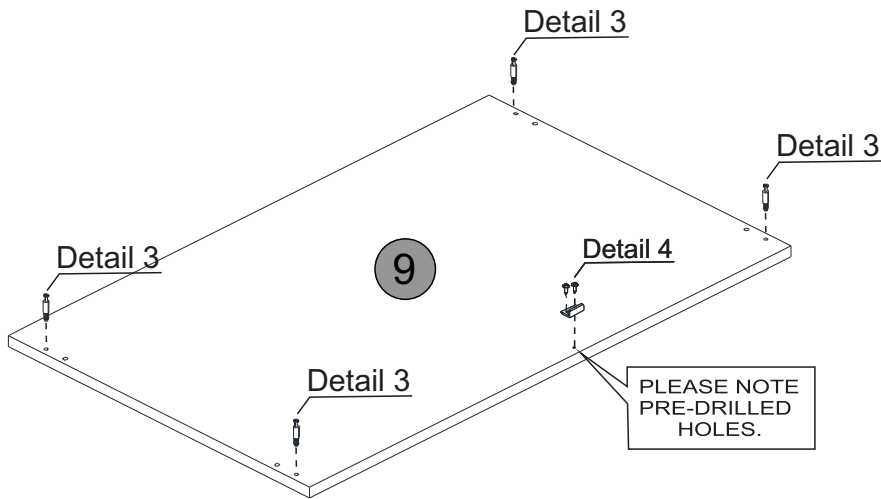
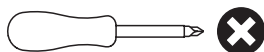

STEP 5

PARTS REQUIRED

6- LEFT SIDE PANEL x1

HARDWARE REQUIRED

A  01

B  Ø6 x 30mm 04

G  02

TOOLS REQUIRED

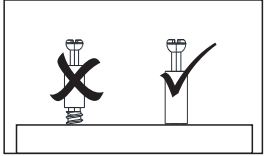
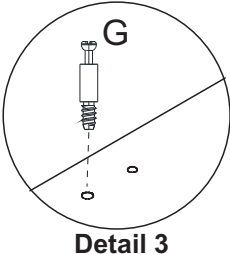
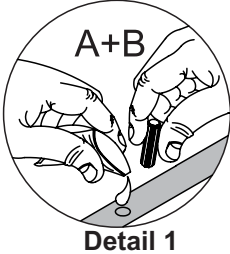
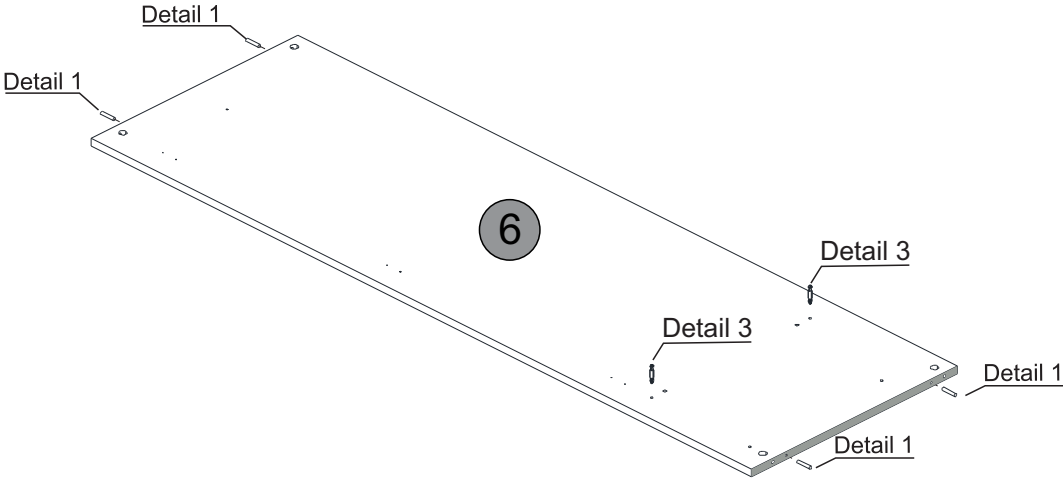
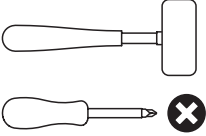

STEP 6

PARTS REQUIRED

6- LEFT SIDE PANEL x1

HARDWARE REQUIRED

I  Ø3,0 x 14mm 02

M  Ø4,0 x 14mm 06

Q  01

T  03

TOOLS REQUIRED

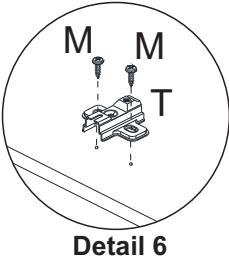
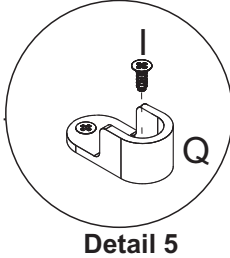
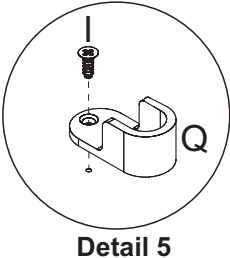
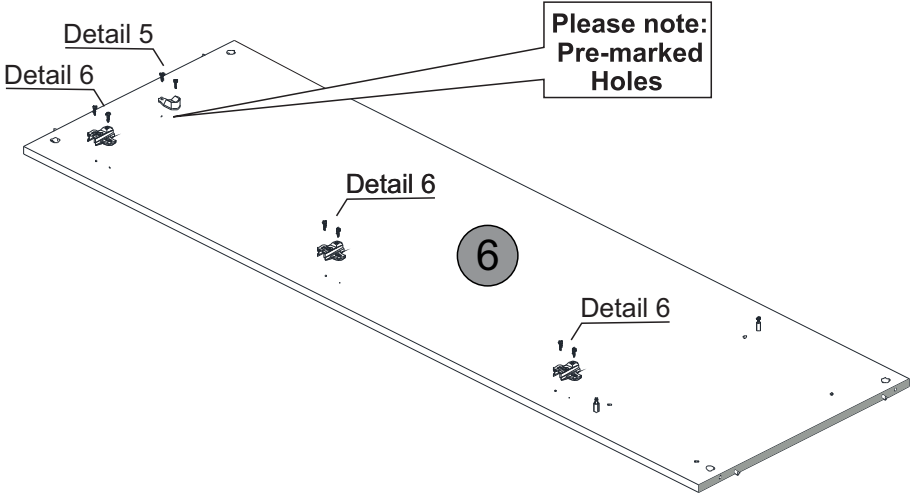
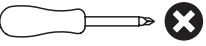

STEP 7

PARTS REQUIRED

6- LEFT SIDE PANEL x1

HARDWARE REQUIRED

C  01
450mm

H  02
Ø6 x 8mm

TOOLS REQUIRED

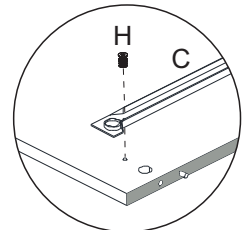
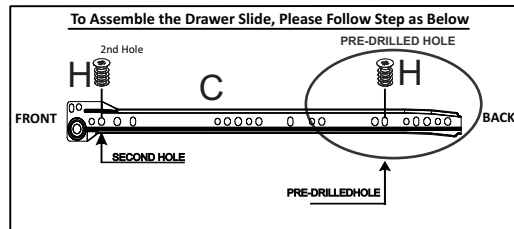
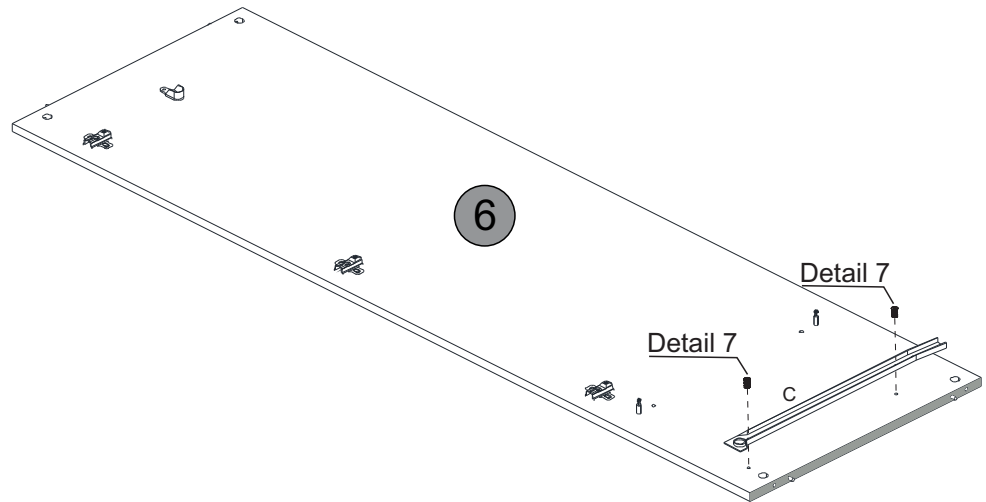

Detail 7

STEP 8

PARTS REQUIRED

8- RIGHT SIDE PANEL x1

HARDWARE REQUIRED

A  01

B  04
Ø6 x 30mm

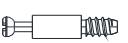
G  02

TOOLS REQUIRED

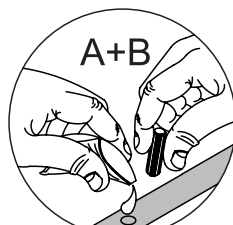
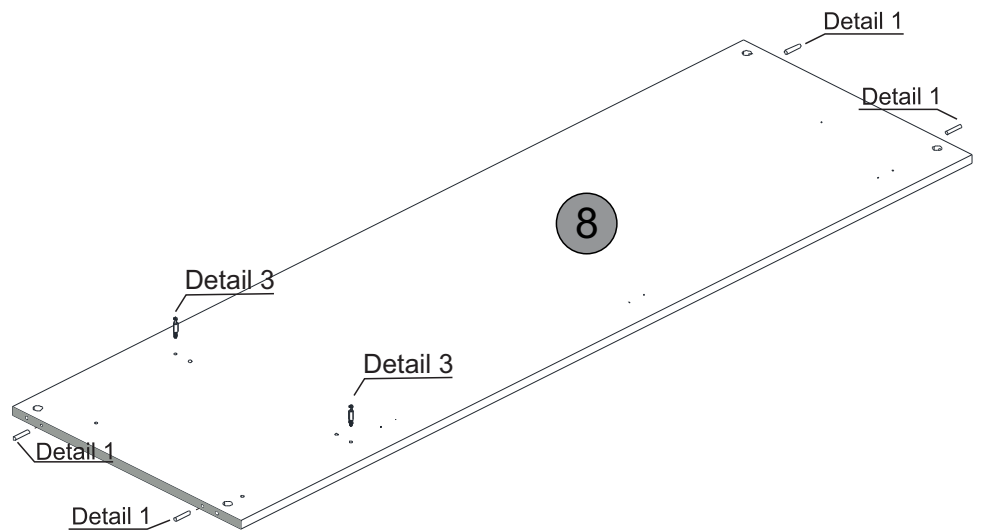
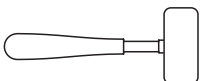

Detail 1

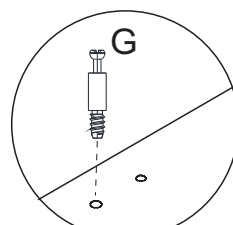

Detail 3

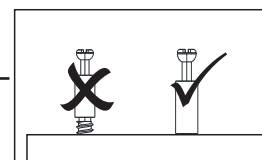

STEP 9

PARTS REQUIRED

8- RIGHT SIDE PANEL x1

HARDWARE REQUIRED

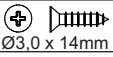
I  02
Ø3.0 x 14mm

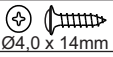
M  06
Ø4.0 x 14mm

Q  01

T  03

TOOLS REQUIRED

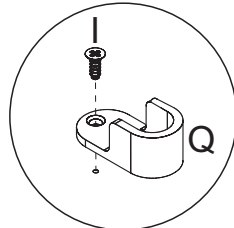
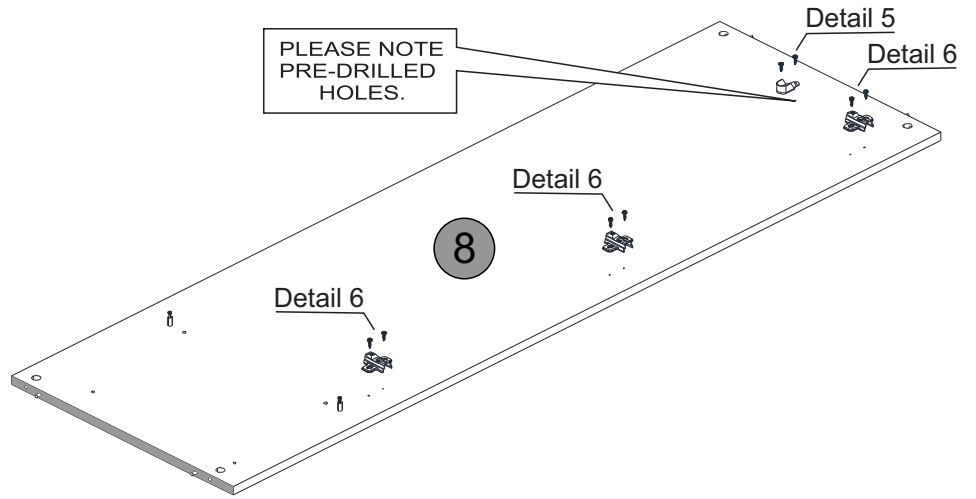
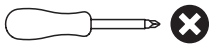

Detail 5

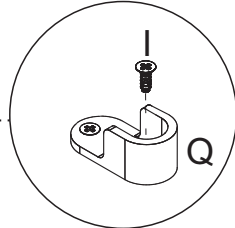

Detail 5

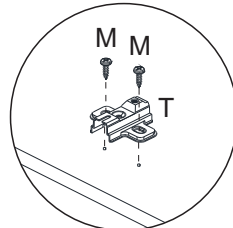

Detail 6

STEP 10

PARTS REQUIRED

8- RIGHT SIDE PANEL x1

HARDWARE REQUIRED

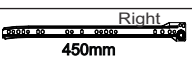
C  01
450mm Right

H  02
Ø6 x 8mm

TOOLS REQUIRED

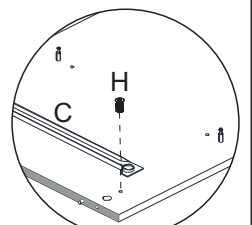
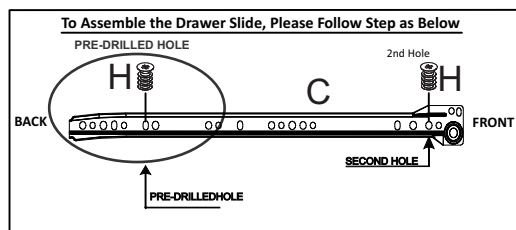
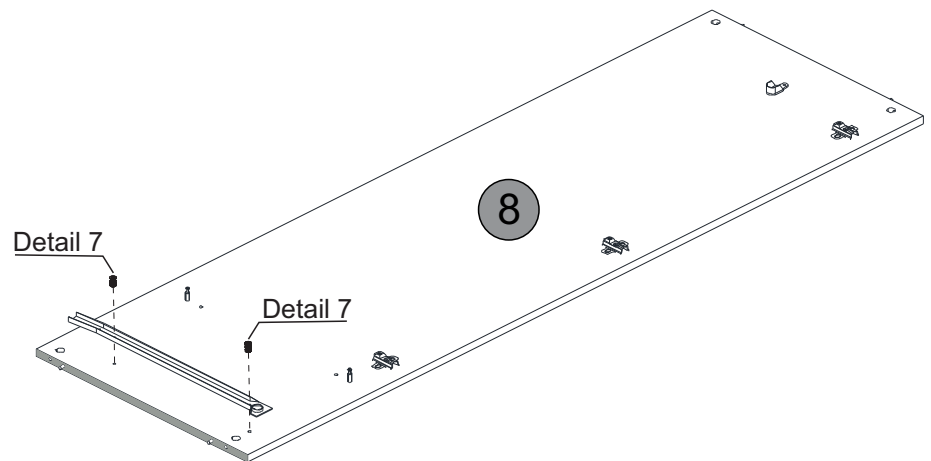
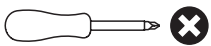



Detail 7

STEP 11

PARTS REQUIRED

1- LEFT FOOT	x2
3- RIGHT FOOT	x2
4- FRONT AND REAR FOOTER	x2

HARDWARE REQUIRED

A		01
O		04

TOOLS REQUIRED

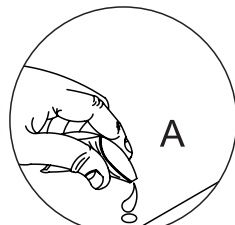
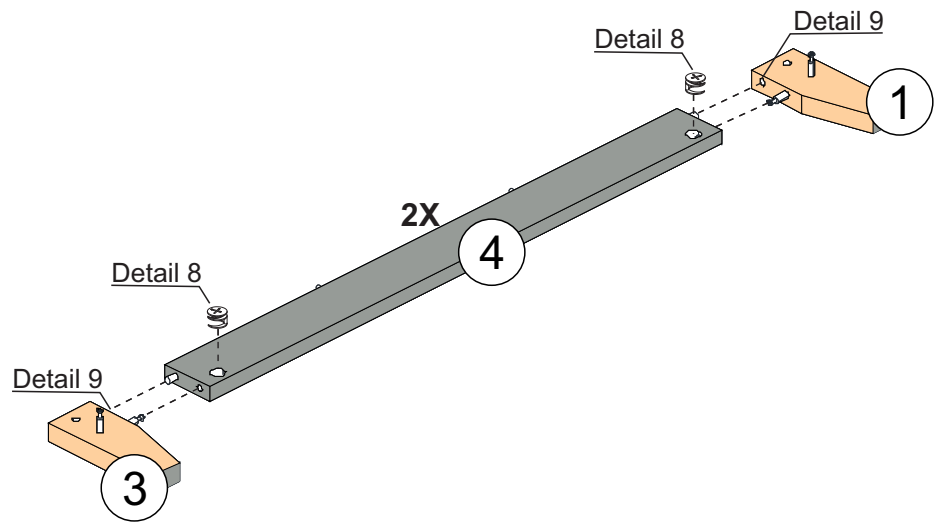
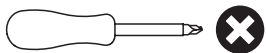

Detail 9

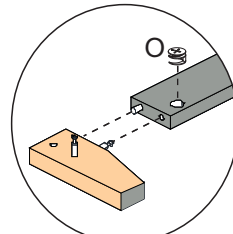

Detail 8

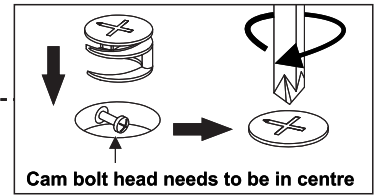



STEP 12

PARTS REQUIRED

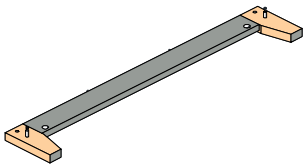
2- SIDE FOOTER	x2
----------------	----



HARDWARE REQUIRED

A		01
O		02

TOOLS REQUIRED

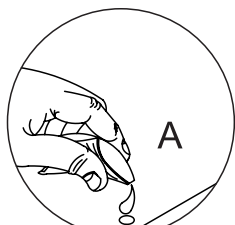
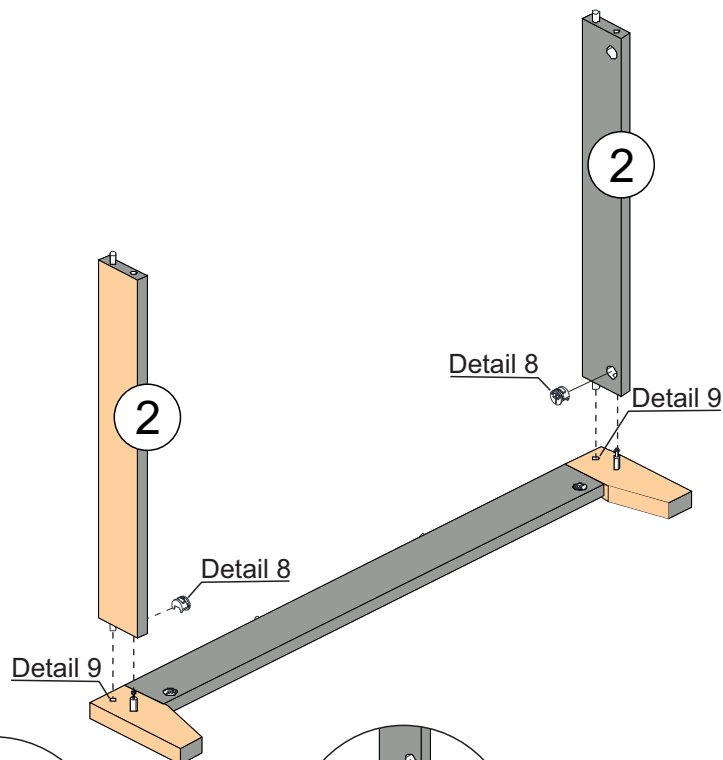
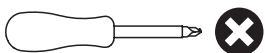

Detail 9

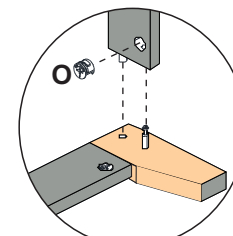

Detail 8

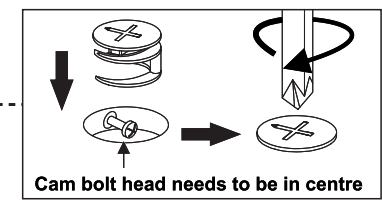

STEP 13

PARTS REQUIRED

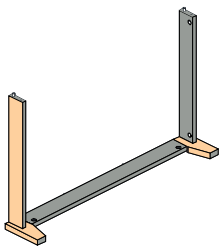

HARDWARE REQUIRED

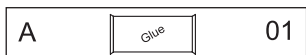

TOOLS REQUIRED

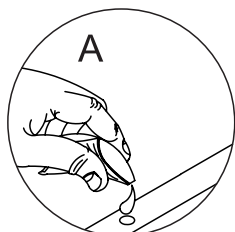
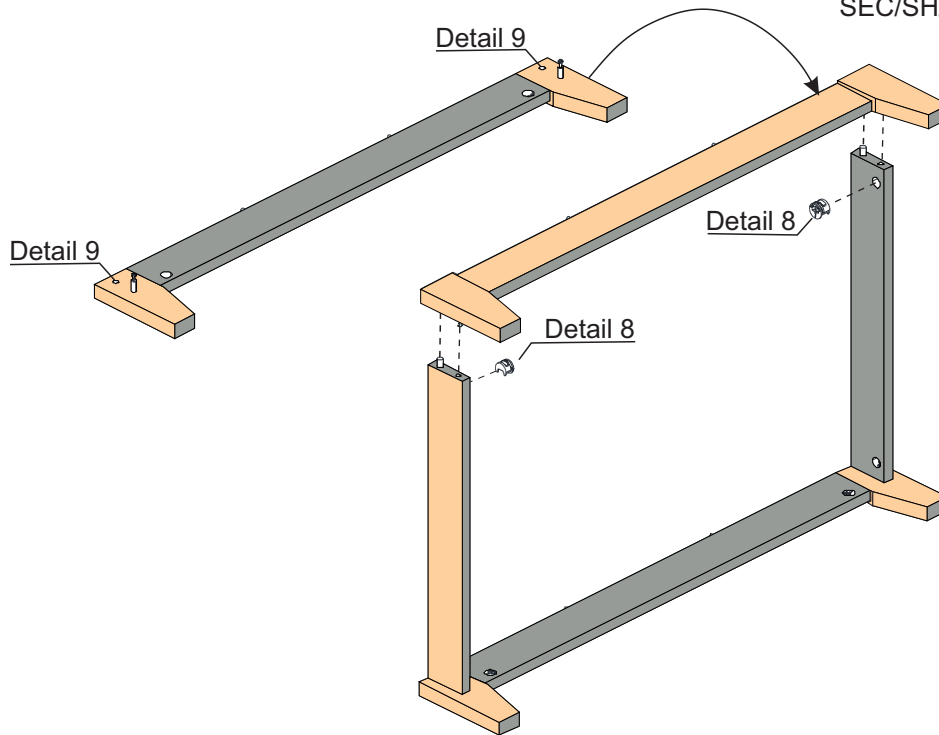
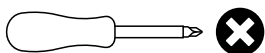

Detail 9

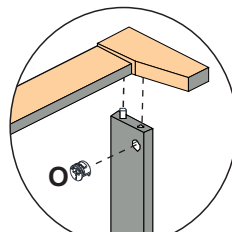

Detail 8

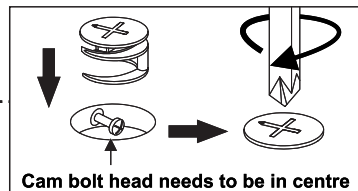

Cam bolt head needs to be in centre

STEP 14

PARTS REQUIRED

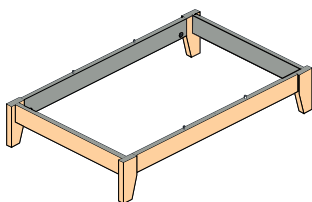

HARDWARE REQUIRED

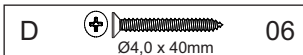
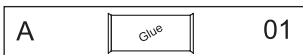

TOOLS REQUIRED

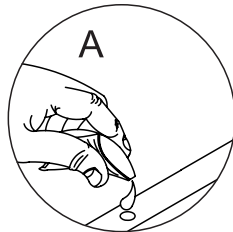
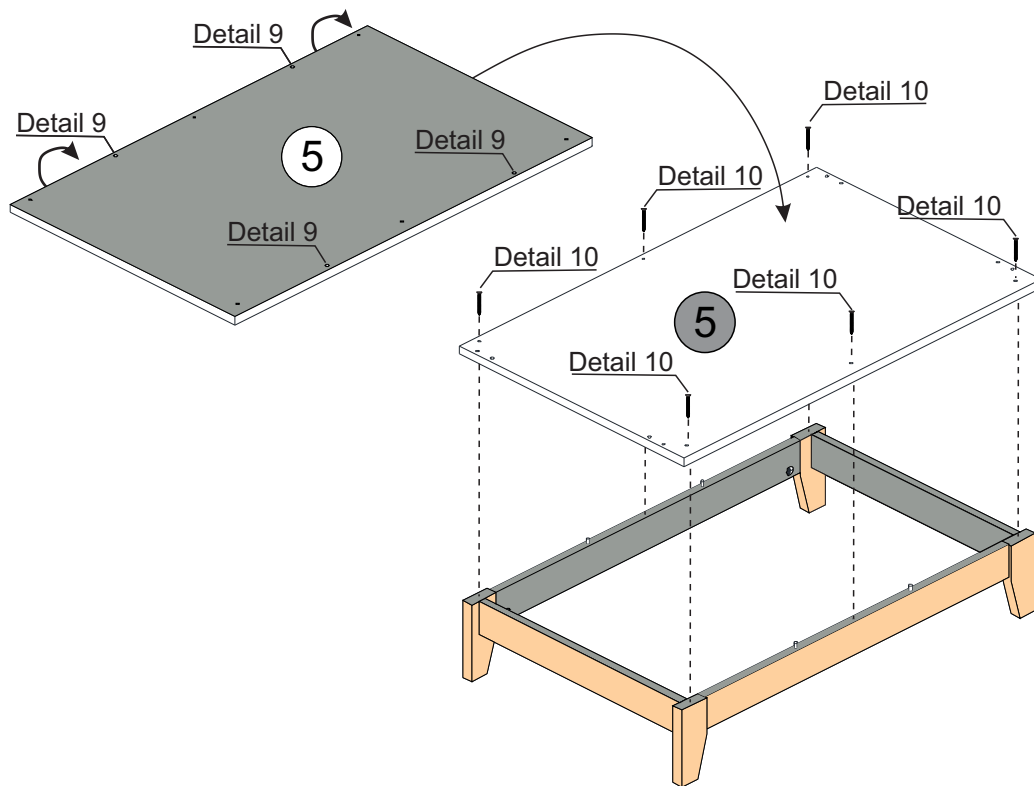
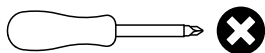

Detail 9

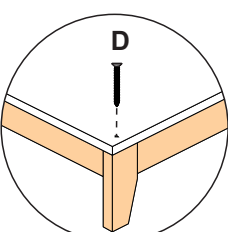

Detail 10

STEP 15

PARTS REQUIRED

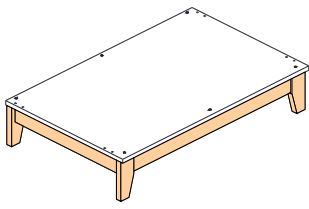

HARDWARE REQUIRED

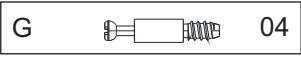

TOOLS REQUIRED

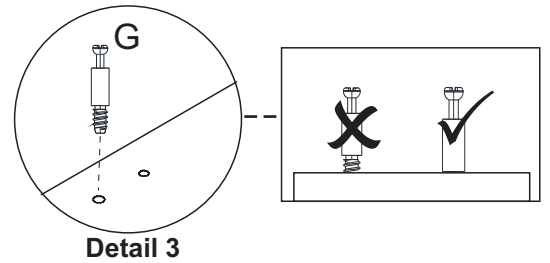
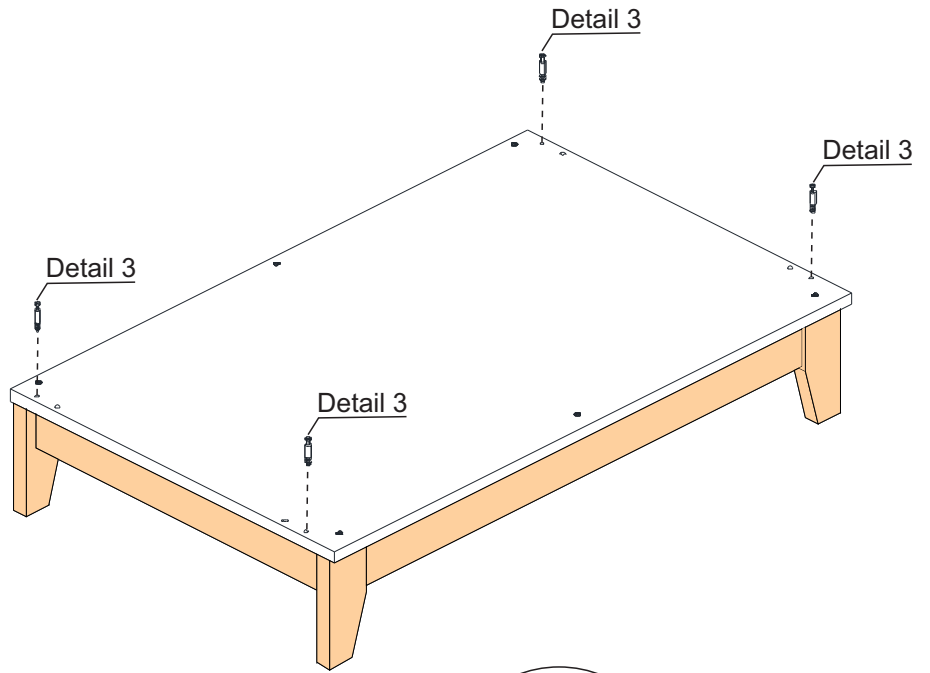
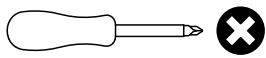

STEP 16

PARTS REQUIRED

6- LEFT SIDE PANEL x1

7- SHELF x1

HARDWARE REQUIRED



TOOLS REQUIRED

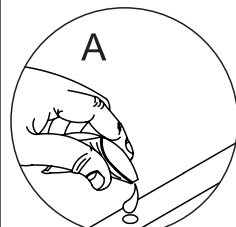
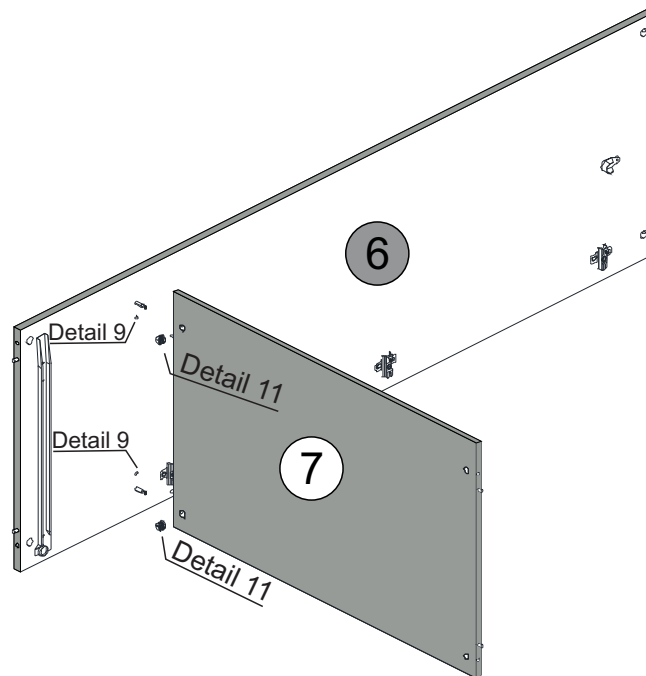
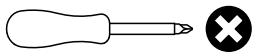

Detail 9

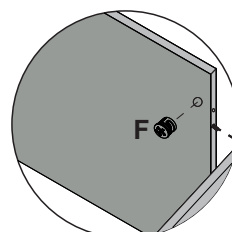

Detail 11

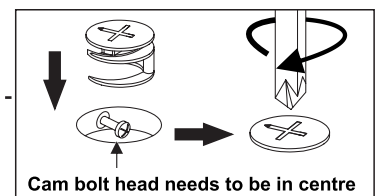

STEP 17

PARTS REQUIRED

8- RIGHT SIDE PANEL x1

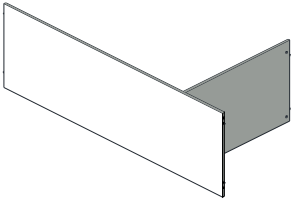

HARDWARE REQUIRED

A  01

F  Ø12mm 02

TOOLS REQUIRED

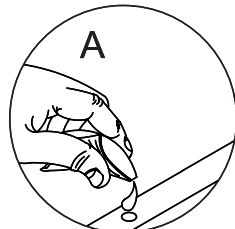
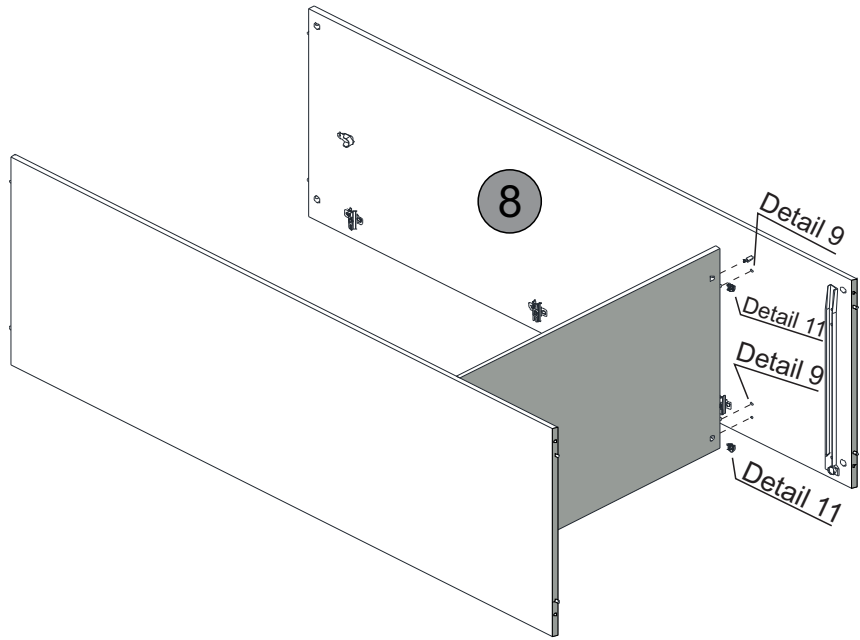
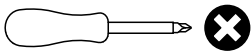

Detail 9

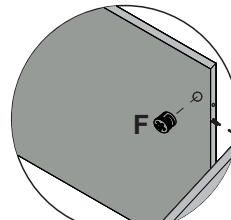

Detail 11

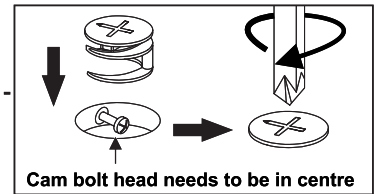

STEP 18

PARTS REQUIRED

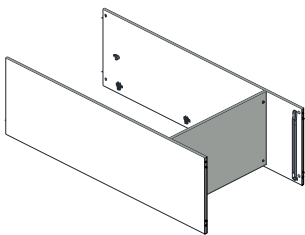

HARDWARE REQUIRED

A  01

O  04

TOOLS REQUIRED

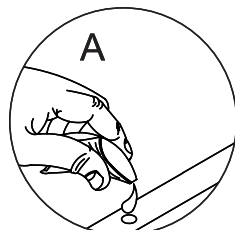
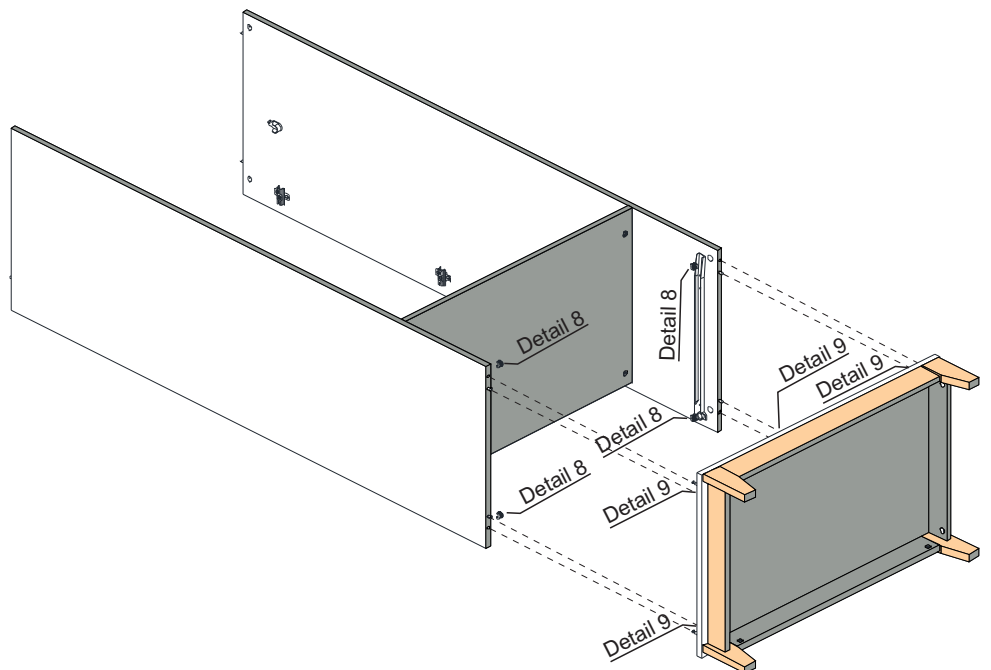
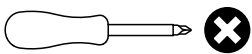

Detail 9

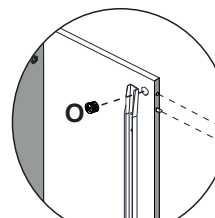

Detail 8

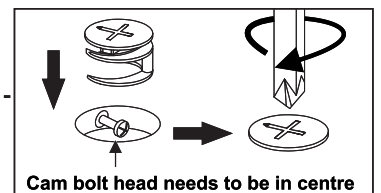

STEP 19

PARTS REQUIRED

9- TOP PANEL x1

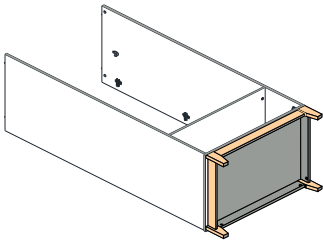

HARDWARE REQUIRED

A  01

O  04

J  04

TOOLS REQUIRED

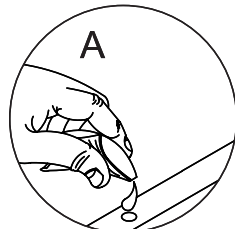
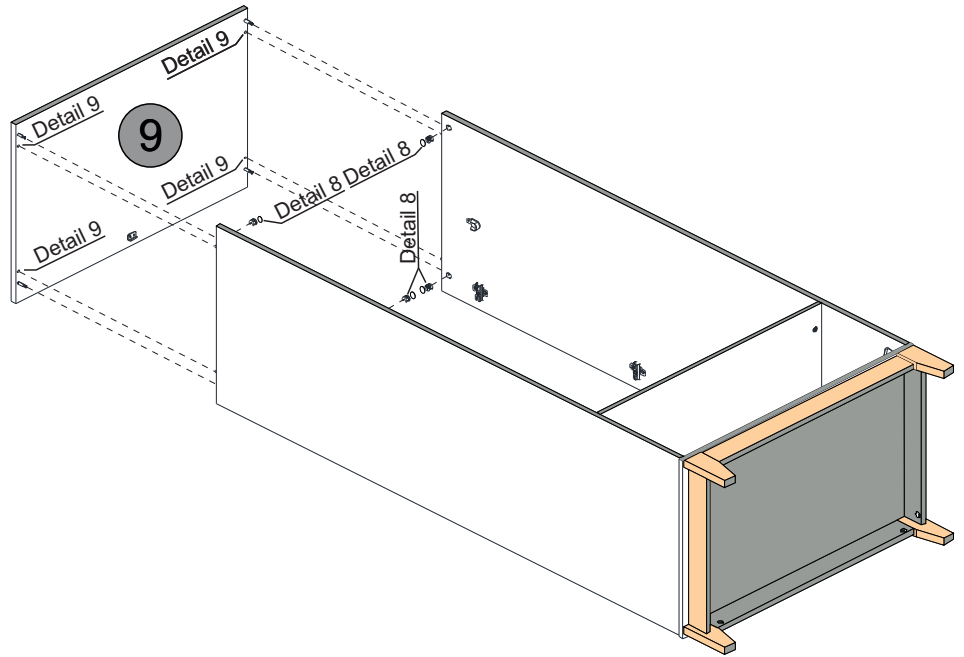
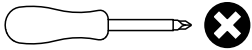

Detail 9

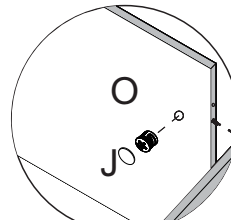

Detail 8

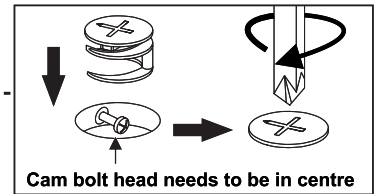

STEP 20

PARTS REQUIRED

10- BACK PANEL x2

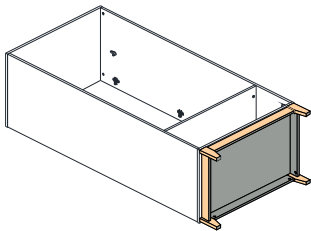

HARDWARE REQUIRED

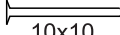
E  10x10 32

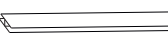
W  01

TOOLS REQUIRED

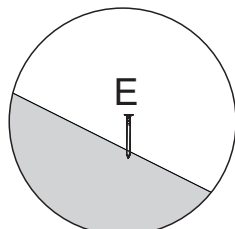
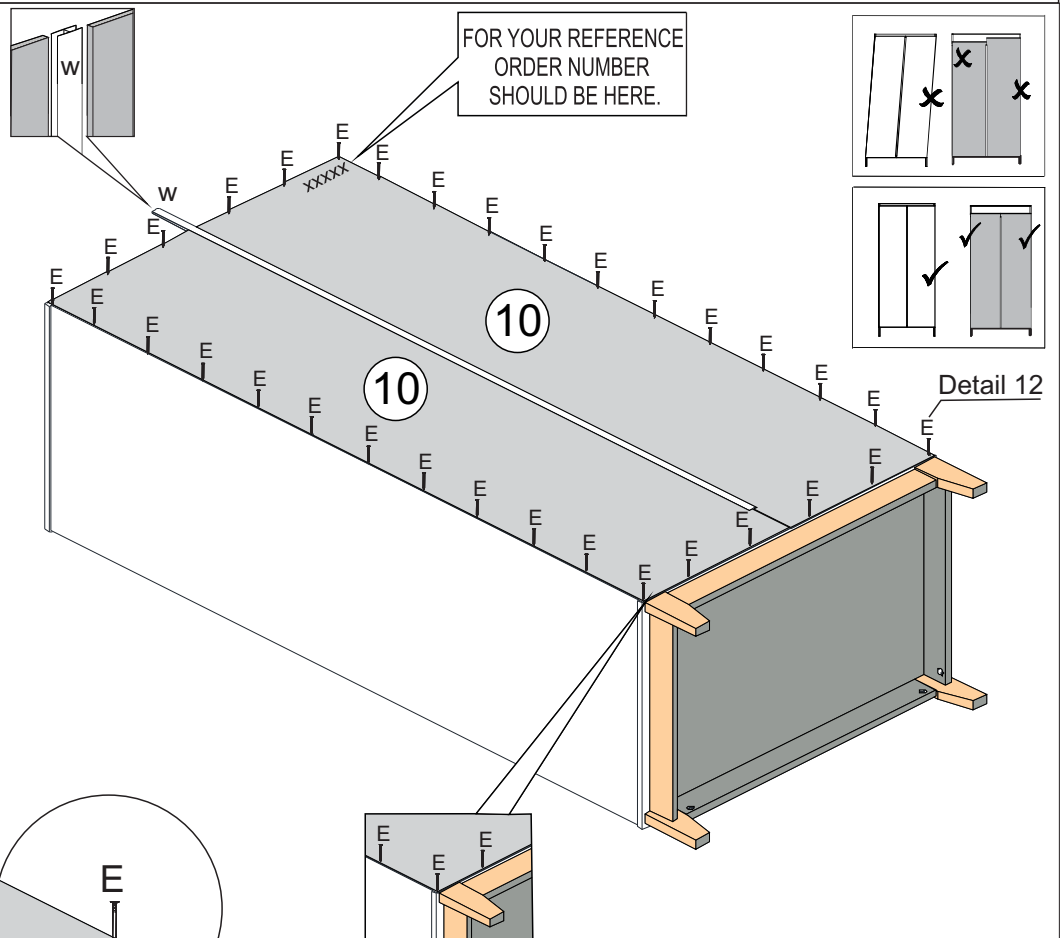
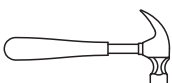

Detail 12

Detail 12

STEP 21

PARTS REQUIRED

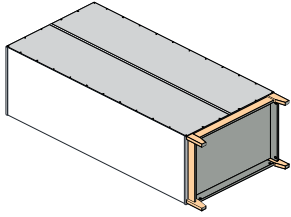

HARDWARE REQUIRED

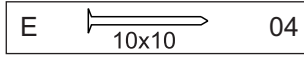

TOOLS REQUIRED

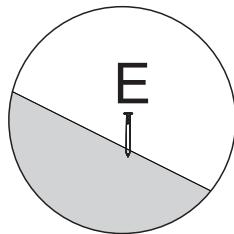
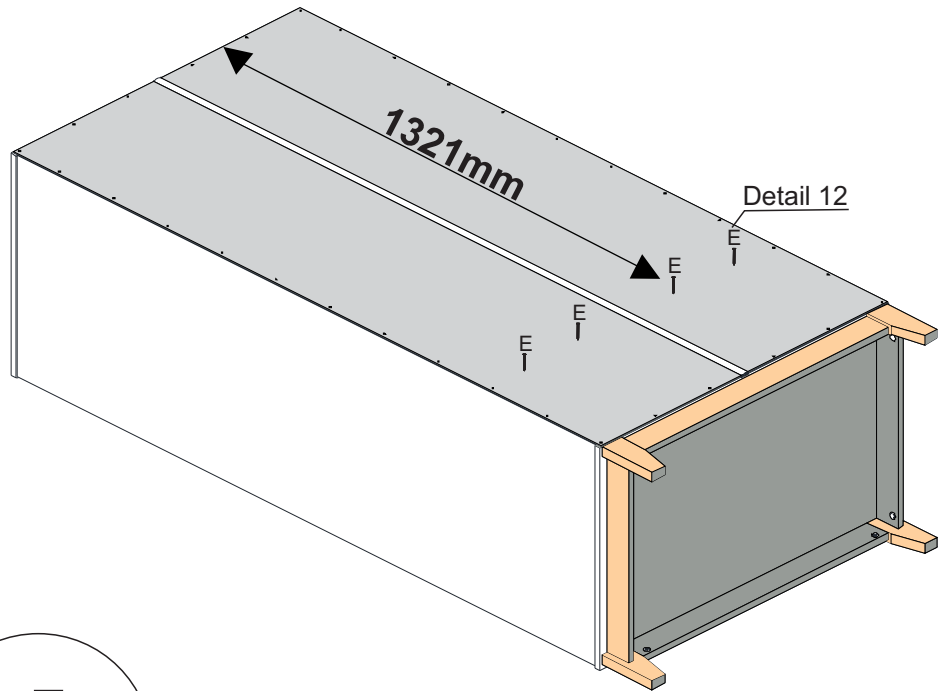
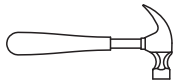

Detail 12

STEP 22

PARTS REQUIRED

- 11- DRAWER SIDES x2
- 12- DRAWER BACK x1
- 14- DRAWER BASE SUPPORT x2

HARDWARE REQUIRED

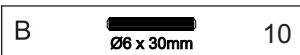
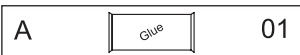

TOOLS REQUIRED

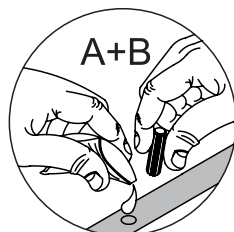
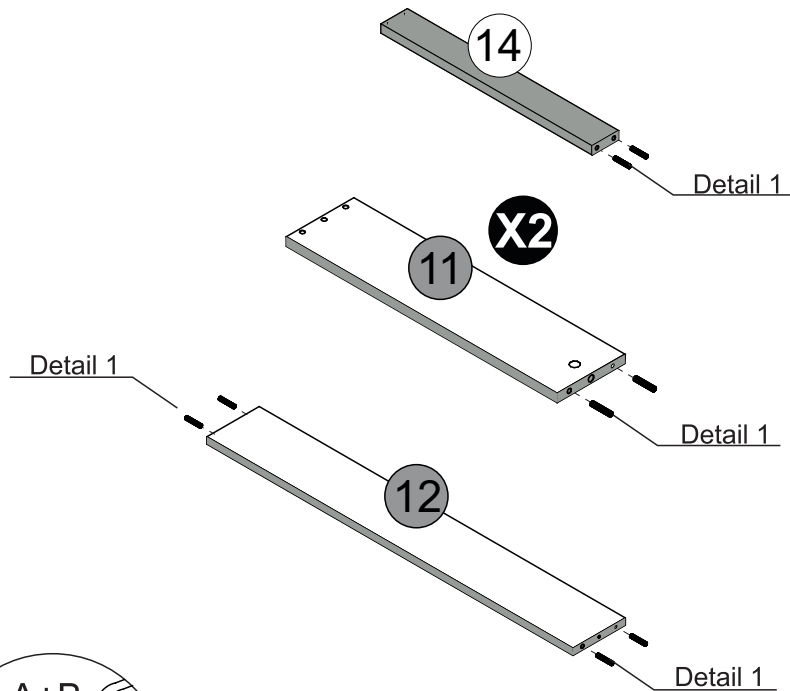
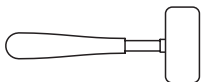

Detail 1

STEP 23

PARTS REQUIRED

15- DRAWER FRONT x1

HARDWARE REQUIRED

G  02

TOOLS REQUIRED

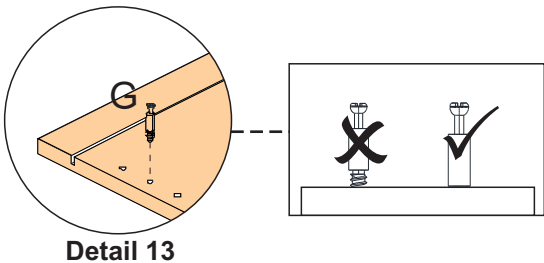
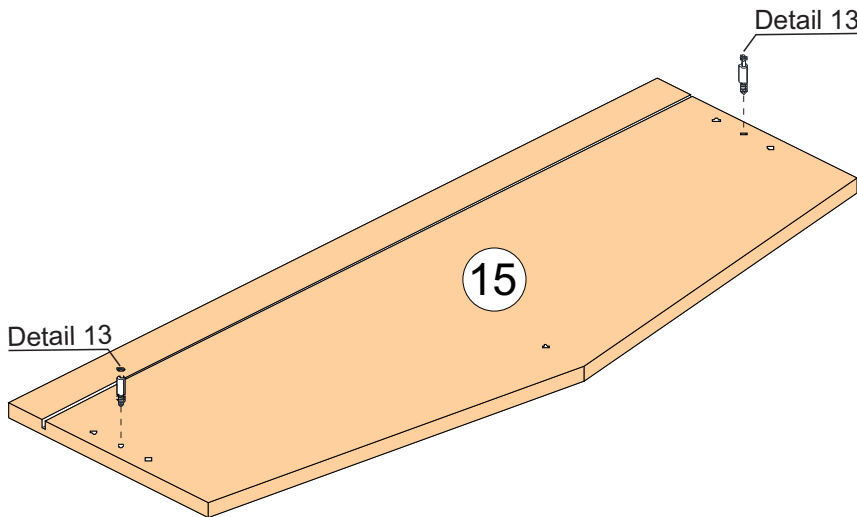
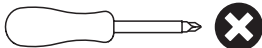

STEP 24

PARTS REQUIRED

11- DRAWER SIDES x2

12- DRAWER BACK x1

HARDWARE REQUIRED

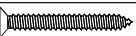
D  Ø4,0 x 40mm 02

TOOLS REQUIRED

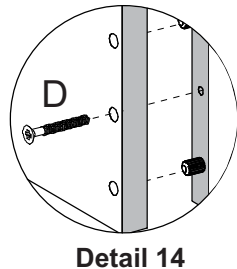
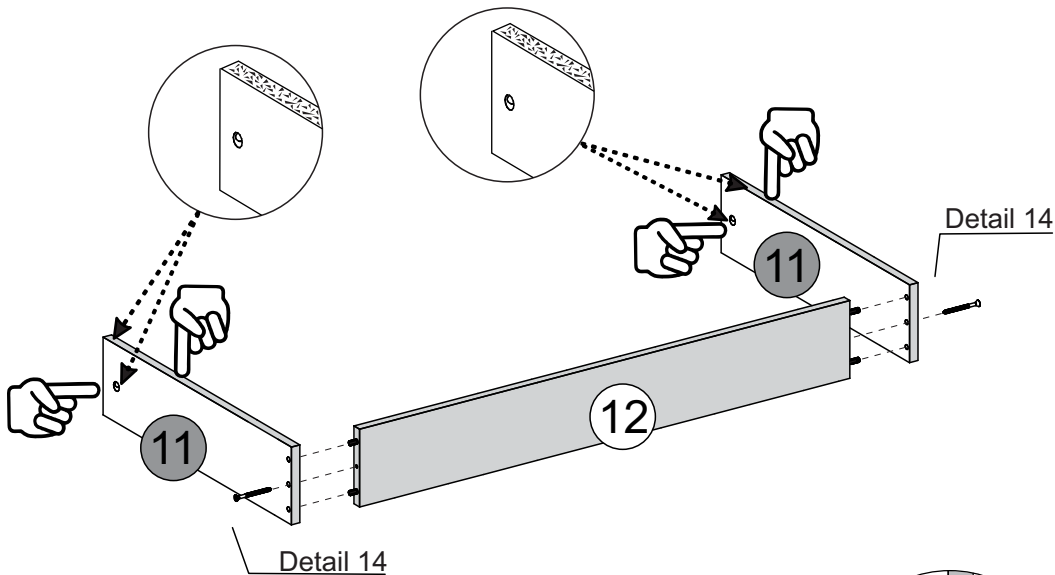
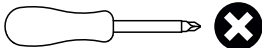

STEP 25

PARTS REQUIRED

15 - DRAWER FRONT x1

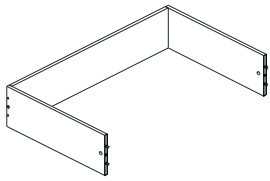

HARDWARE REQUIRED

A 01

F Ø12mm 02

J 02

TOOLS REQUIRED

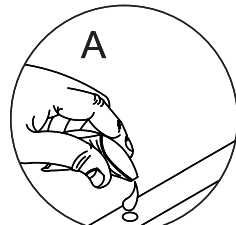
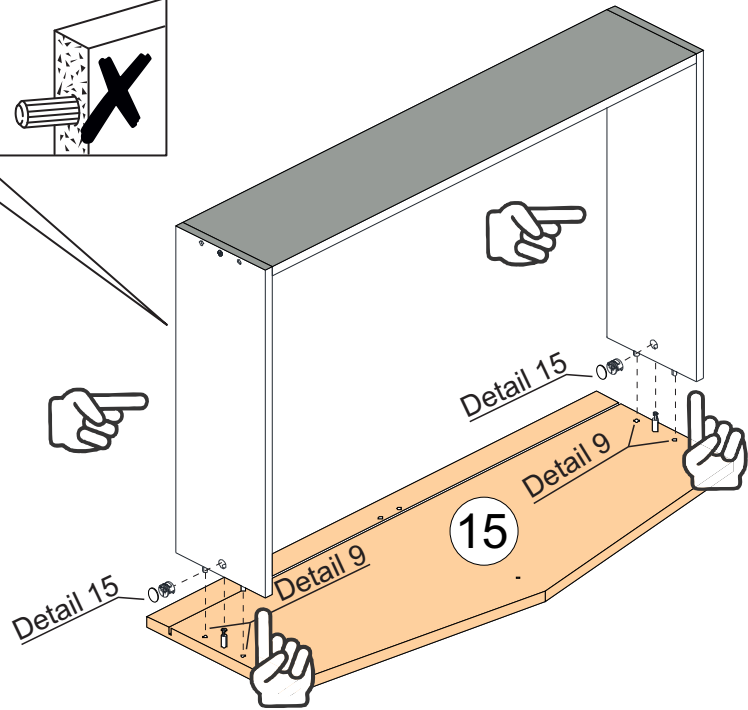
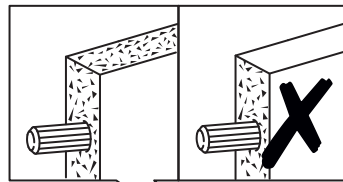
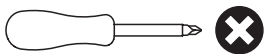

Detail 9

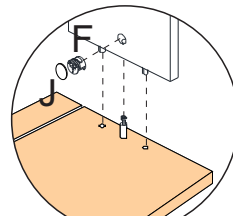

Detail 15

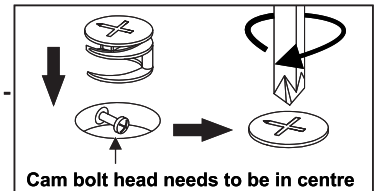

STEP 26

PARTS REQUIRED

13 - DRAWER BASE x1

14 - DRAWER BASE SUPPORT x1

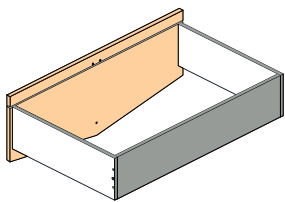

HARDWARE REQUIRED

A 01

E 08

TOOLS REQUIRED

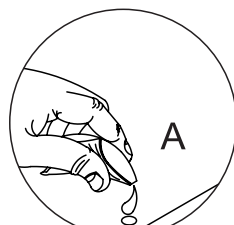
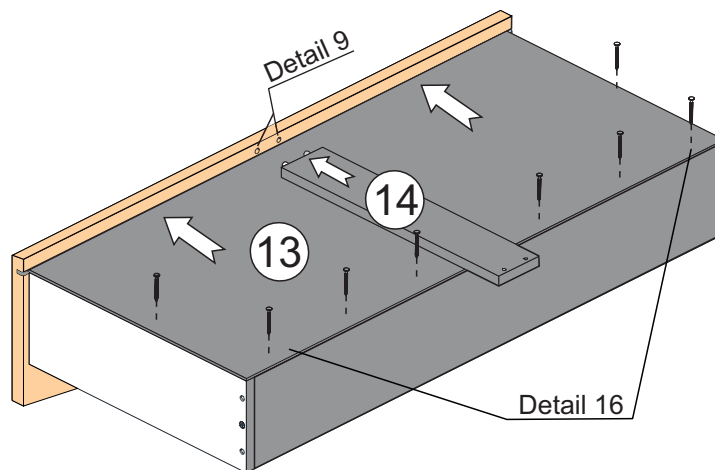
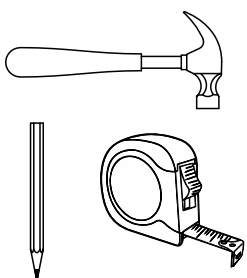

Detail 9

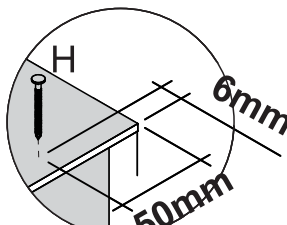

Detail 16

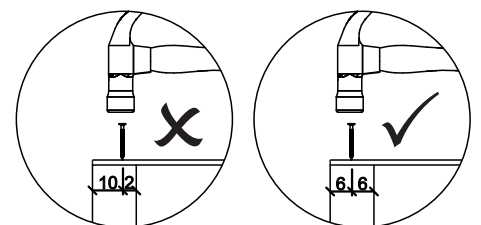
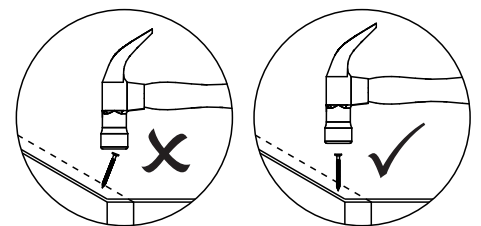

STEP 27

PARTS REQUIRED

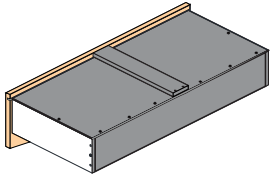

HARDWARE REQUIRED

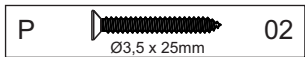
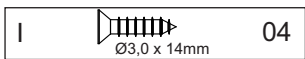

TOOLS REQUIRED

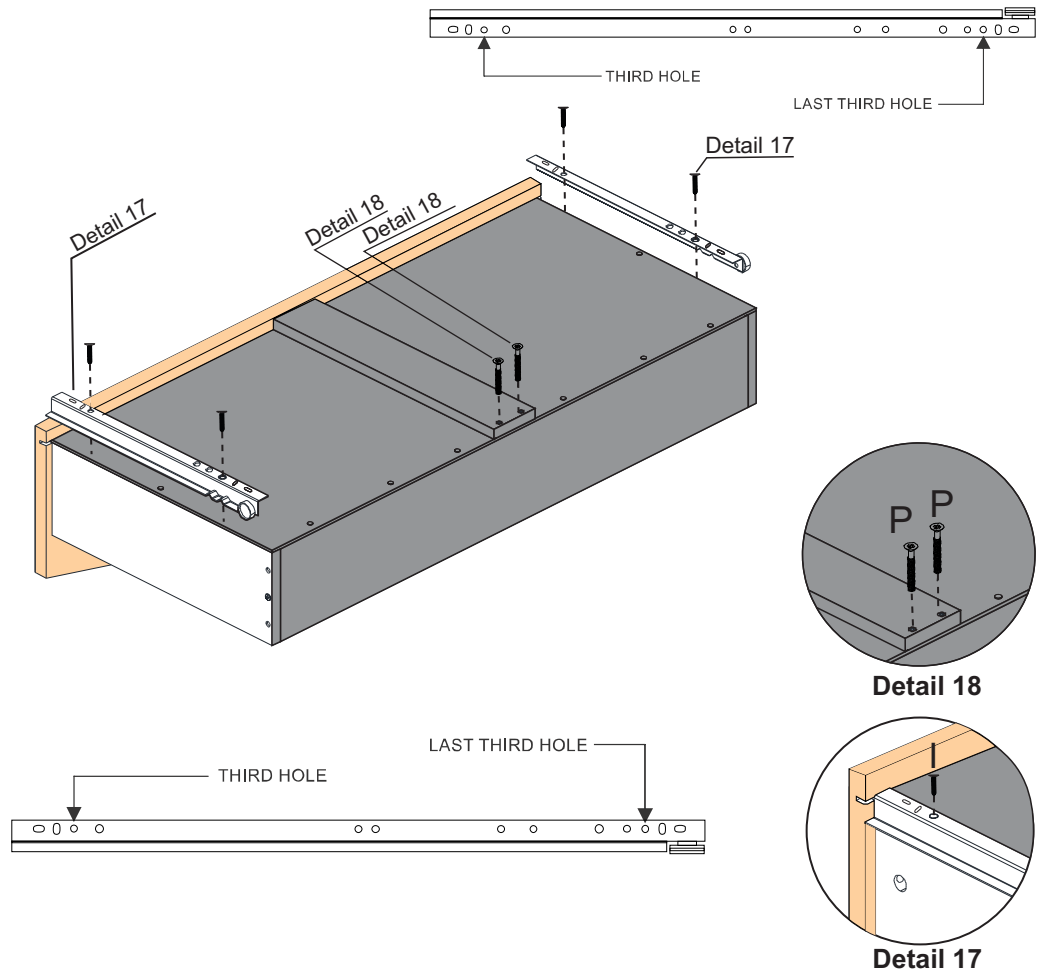
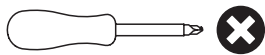

STEP 28

PARTS REQUIRED

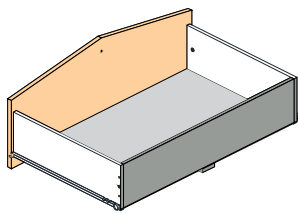

HARDWARE REQUIRED

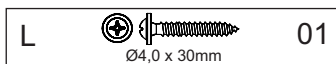
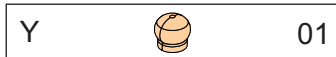

TOOLS REQUIRED

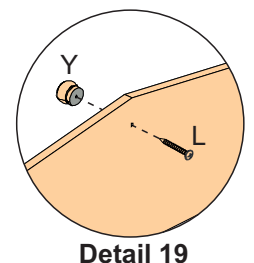
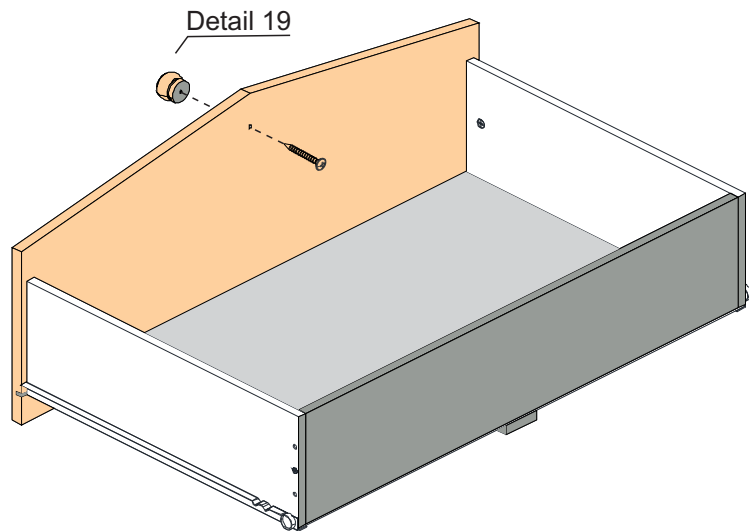
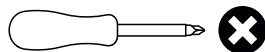

Detail 19

STEP 29

PARTS REQUIRED

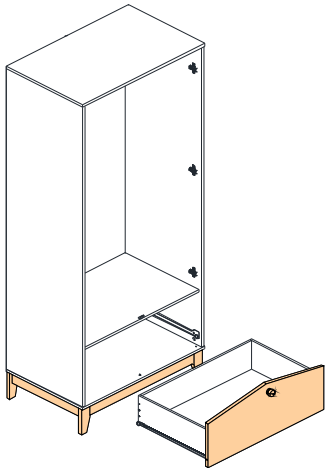

HARDWARE REQUIRED

TOOLS REQUIRED

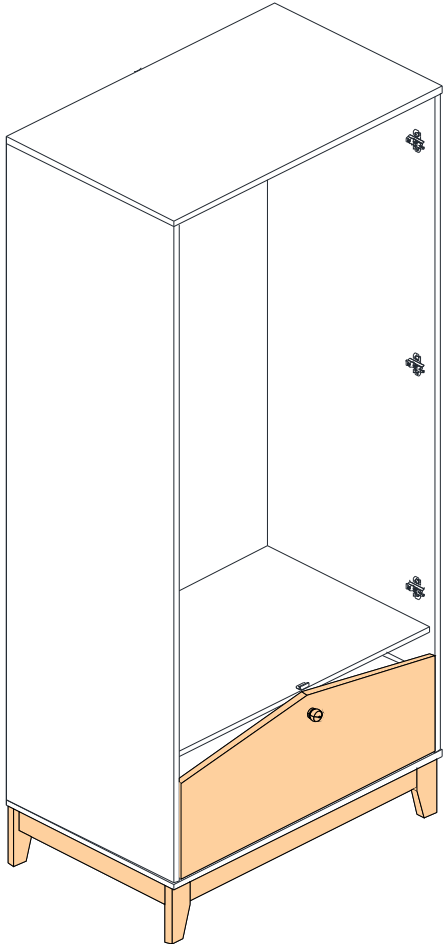

STEP 30

PARTS REQUIRED

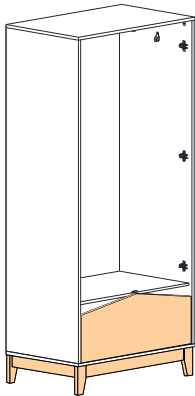

HARDWARE REQUIRED

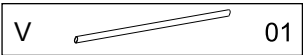

TOOLS REQUIRED

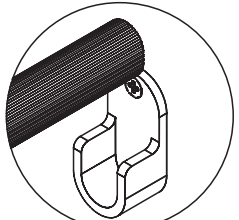
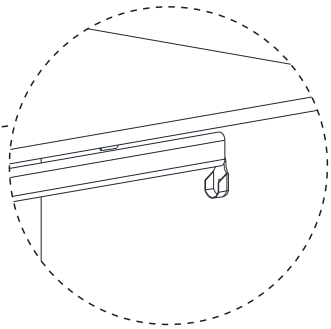
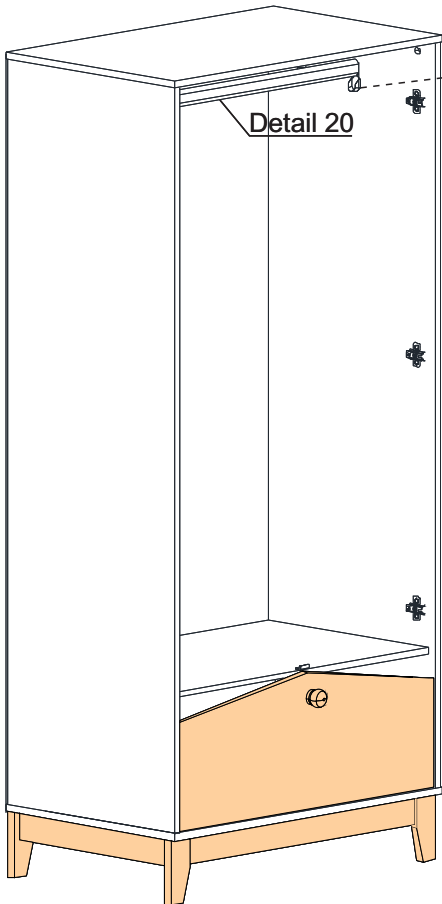

Detail 20

STEP 31

PARTS REQUIRED

16- LEFT DOOR x1

17- RIGHT DOOR x1

HARDWARE REQUIRED

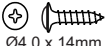
M  12
Ø4,0 x 14mm

R  06

TOOLS REQUIRED

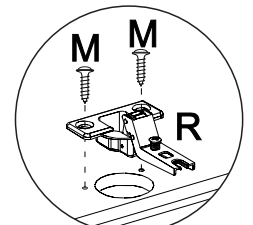
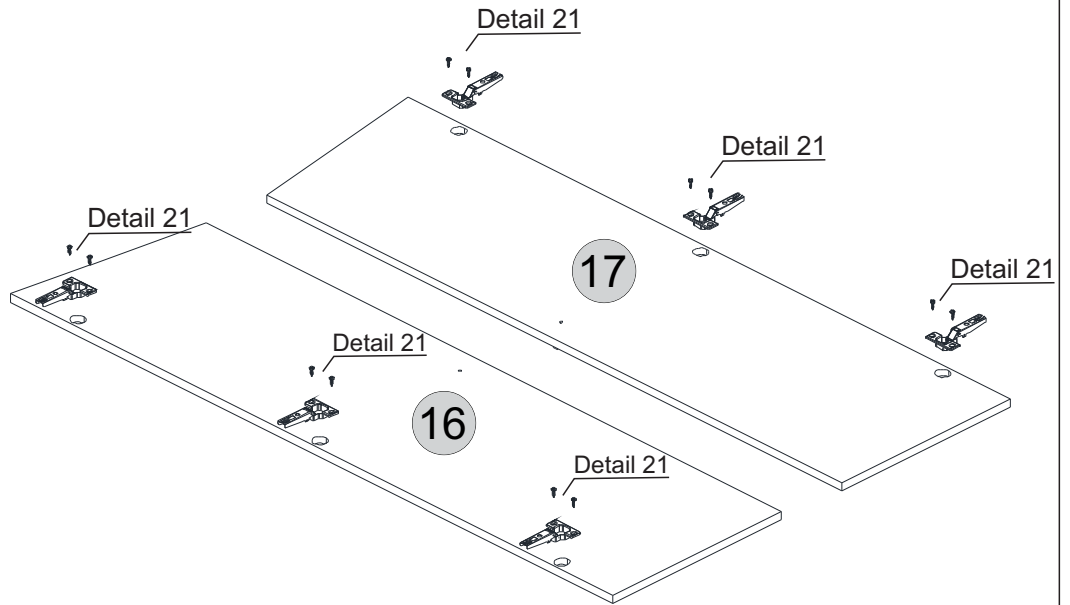
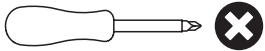

Detail 21

STEP 32

PARTS REQUIRED

16- LEFT DOOR x1

17- RIGHT DOOR x1

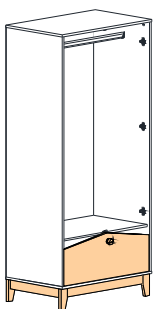

HARDWARE REQUIRED

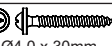
L  02
Ø4,0 x 30mm

Y  02

TOOLS REQUIRED

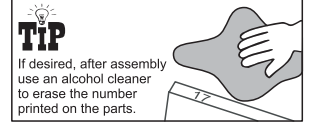
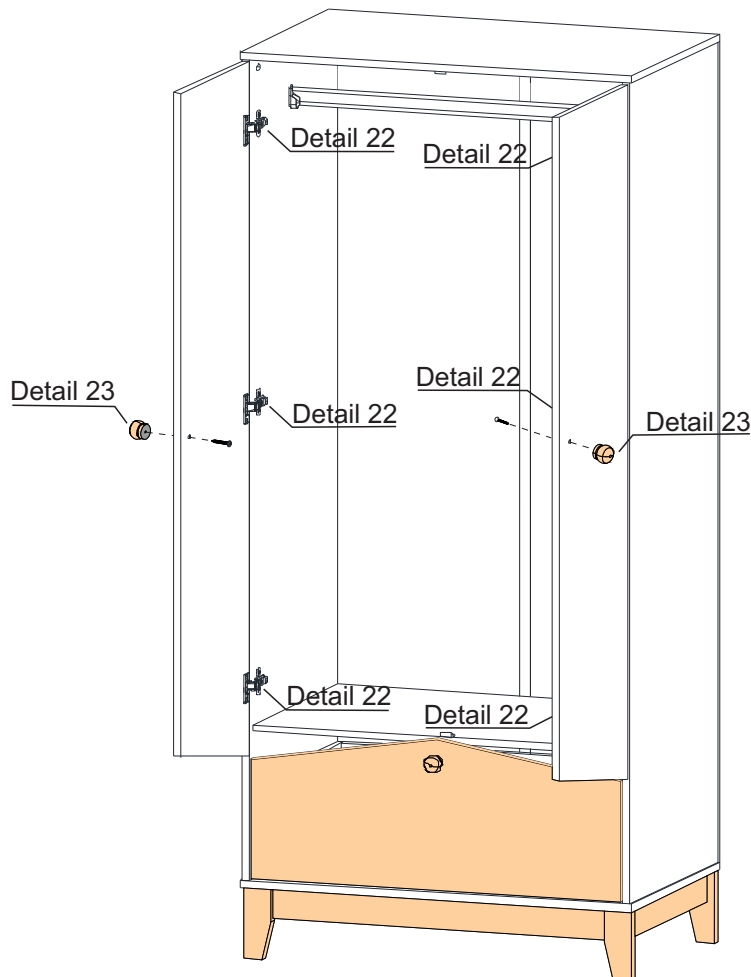
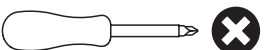

TIP

If desired, after assembly use an alcohol cleaner to erase the number printed on the parts.

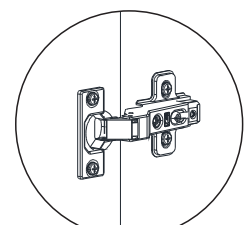

Detail 22

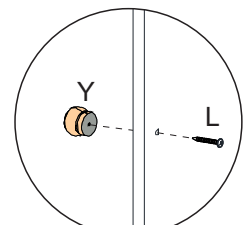

Detail 23

STEP 33

PARTS REQUIRED

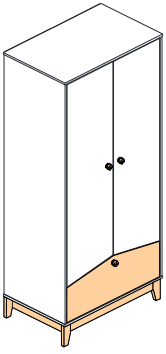

HARDWARE REQUIRED

K  01

TOOLS REQUIRED

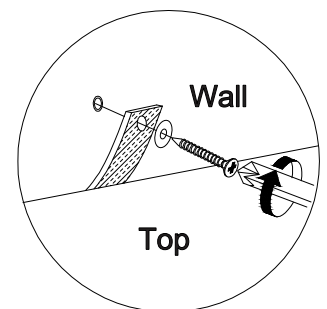
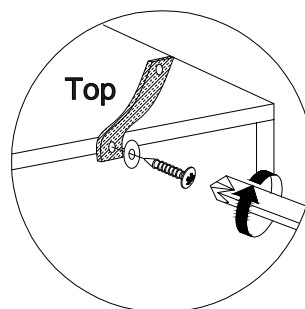
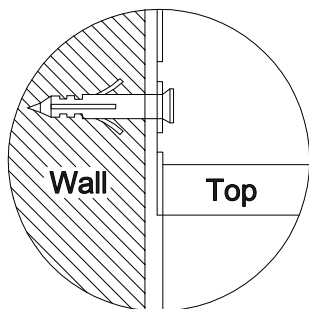
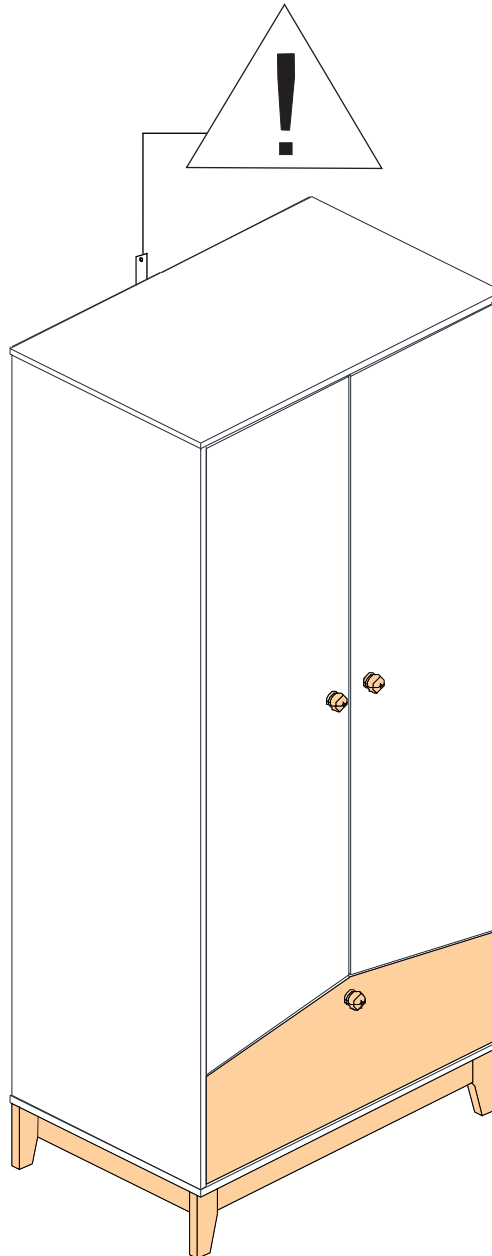
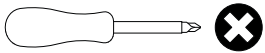

WARNING

Serious or fatal injuries can occur from furniture tipping over. To prevent the furniture from tipping over we recommend that it is permanently fixed to the wall.

Wall fixings are not supplied with this product as different wall materials require different types of fixing devices. Please make sure you use fixings suitable for the walls in your home.