

# NEVADA MIRRORED 2 DOOR WARDROBE ASSEMBLY INSTRUCTIONS

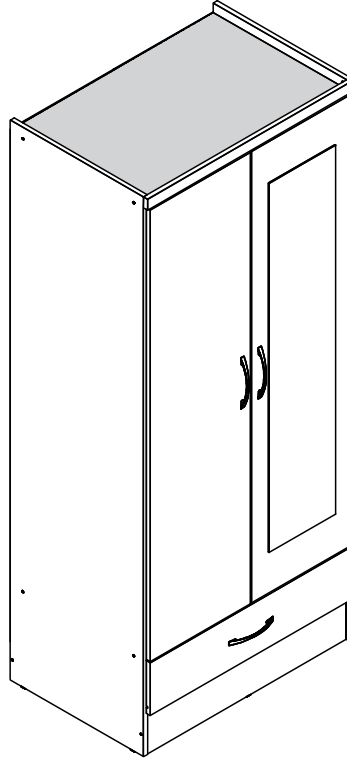

## IMPORTANT

### FOR DOMESTIC USE ONLY

PLEASE READ BEFORE YOU CONTINUE FURTHER

## CARE AND MAINTENANCE

After unpacking this product please keep the original packaging in case it needs to be returned for any reason.

- Please ensure all fittings and parts are present before commencing with assembly.
- Never drag or push products as this could cause damage to the joints making it inferior.
- We strongly recommend that you keep children away from your work area.
- We recommend that you lay a blanket or sheet on the floor to avoid damage to both your floor and the product.
- Assemble this product as close to its final position as possible.
- Do not place this product next to a radiator or in direct sunlight.
- Do not drag or push items across your high gloss furniture as this may cause the surface to scratch
- Wood is a natural product and may expand if subjected to damp and may shrink or crack if subjected to heat. Therefore it is recommended that room temperature is maintained, with no sudden temperature fluctuations.
- Make sure any spillage is wiped off immediately.
- Do not place hot or chilled items directly on to the surface, use a place mat or marking will occur.
- For general cleaning use a soft cotton or micro fibre cloth, and do not use detergents of any kind.
- From time to time it may be necessary to tighten fittings, regular inspections should be carried out.
- Do not place on a wet or damp floor as staining may occur to your floor.

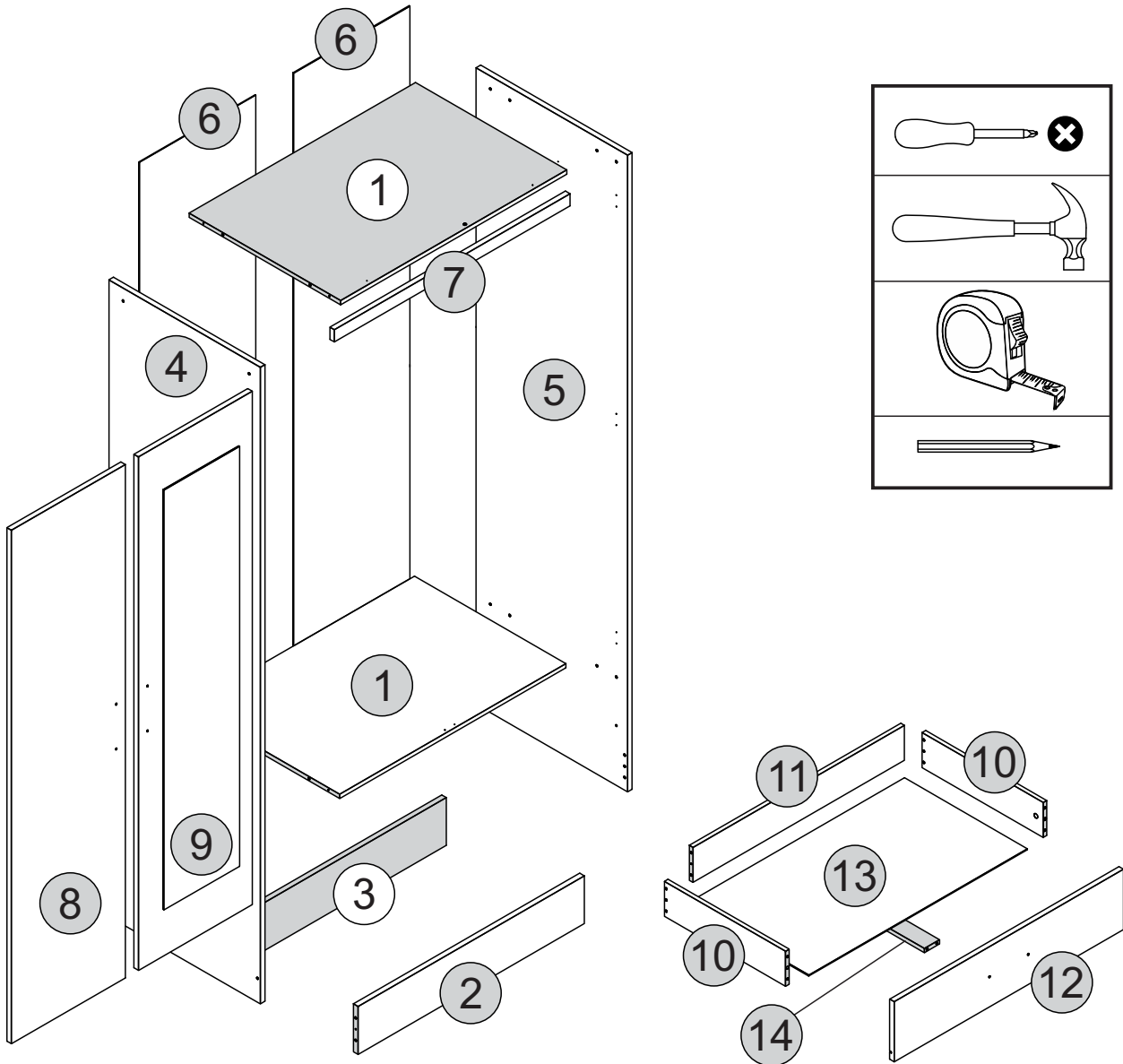









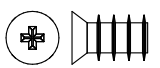
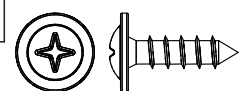

**PARTS LIST**

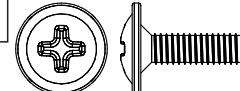
**Please Note:**  
The below parts have all been stamped with the part number to help identify them during assembly.

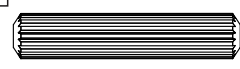
Part Number	Part Description	Quantity	Carton
01	Base-Top Panel	2	1/2
02	Front Baseboard	1	2/2
03	Back Baseboard	1	2/2
04	Left Side Panel	1	1/2
05	Right Side Panel	1	1/2
06	Back Panel	2	1/2
07	Frame	1	2/2
08	Door	1	2/2
09	Mirrored Door	1	2/2
10	Drawer Side	2	1/2
11	Drawer Back Panel	1	2/2
12	Drawer Front	1	2/2
13	Drawer Bottom	1	1/2
14	Drawer Bottom Support Bar	1	2/2

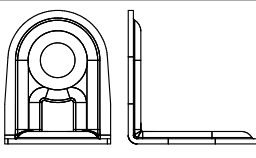
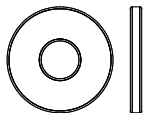
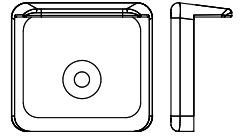
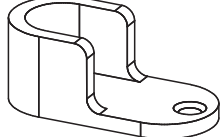
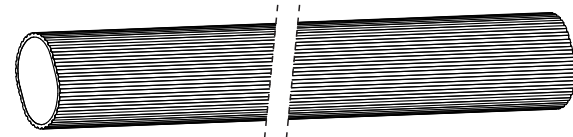
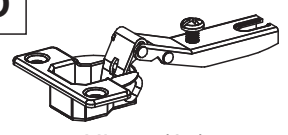
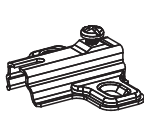
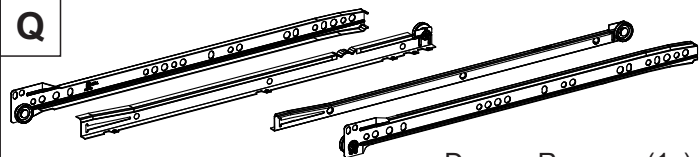
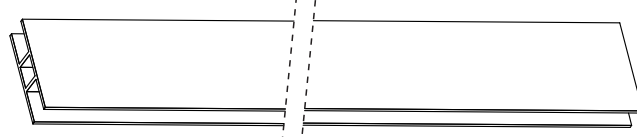
# FITTINGS LIST

SEC/AY/06/21/CA7

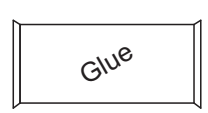
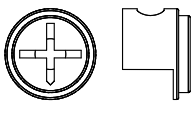
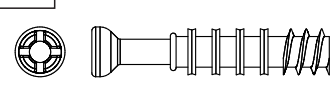
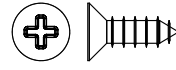
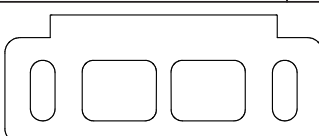
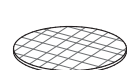
<b>A</b>  Flat Head Screw 1/+ Ø6,0 x 10mm (4x)	<b>B</b>  Flan Head Screw 1/+ Ø4,0 x 14mm (6x)	<b>C</b>  Flat Head Screw 2/+ Ø4,0 x 14mm (34x)	<b>D</b>  Flan Head Screw 1/+ Ø4,0 x 20mm (6x)
<b>E</b>  Flat Head Screw 1/+ Ø3,5 x 40mm (2x)	<b>F</b>  Flat Head Screw 2/+ Ø4,0 x 50mm (14x)	<b>G</b>  2/+ Dowel Ø6,0 x 30mm (26x)	
<b>H</b>  2/+ Nail 10 x 10 (58x)	<b>I</b>  1/+ Flan Head Screw Ø3,5 x 30mm (2x)	<b>J</b>  1/+ 'L' Metallic Support (4x)	<b>K</b>  1/+ Washer (4x)
<b>L</b>  Plastic Foot (6x)	<b>M</b>  Hanging Rail Support (2x)	<b>N</b>  Hanging Rail (1x)	
<b>O</b>  Hinge (6x)	<b>P</b>  Hinge Plate (6x)	<b>Q</b>  Drawer Runners (1x)	
<b>R</b>  Back Panel Strip (1x)	<b>S</b>  Strap (2x)	<b>T</b>  Handle (3x)	
<b>U</b>  2/+ Hole Plugs (12x)	<b>V</b>  Glue (1x)	<b>W</b>  1/+ Cam Nut (2x)	<b>X</b>  1/+ Cam Bolt (2x)
<b>Y</b>  2/+ Flat Head Screw Ø4,0 x 12mm (12x)	<b>Z</b>  Door Support (2x)	<b>A1</b>  2/+ Hole Plugs (2x)	

## TIPS FOR FITTINGS CAM-LOCKS

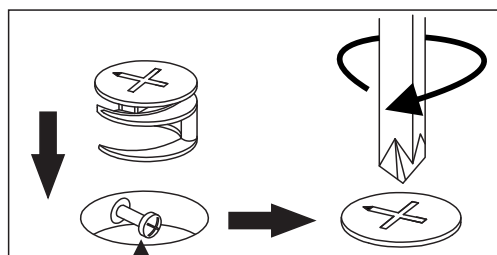
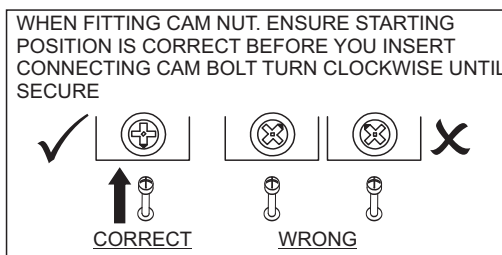

### CAMBOLT

Tighten until shoulder is flush with panel. Do not overtighten or undertighten (see example beside)

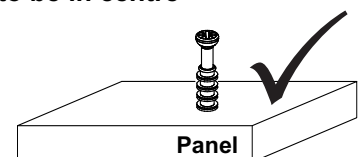
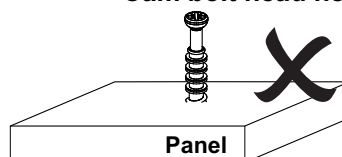
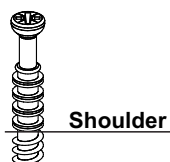



# STEP 1

## PARTS REQUIRED

4 - LEFT SIDE PANEL x1

## HARDWARE REQUIRED

A  02  
Ø6,0 x 10mm

H  02  
10 x 10

L  02

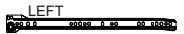
Q  01  
LEFT

## TOOLS REQUIRED

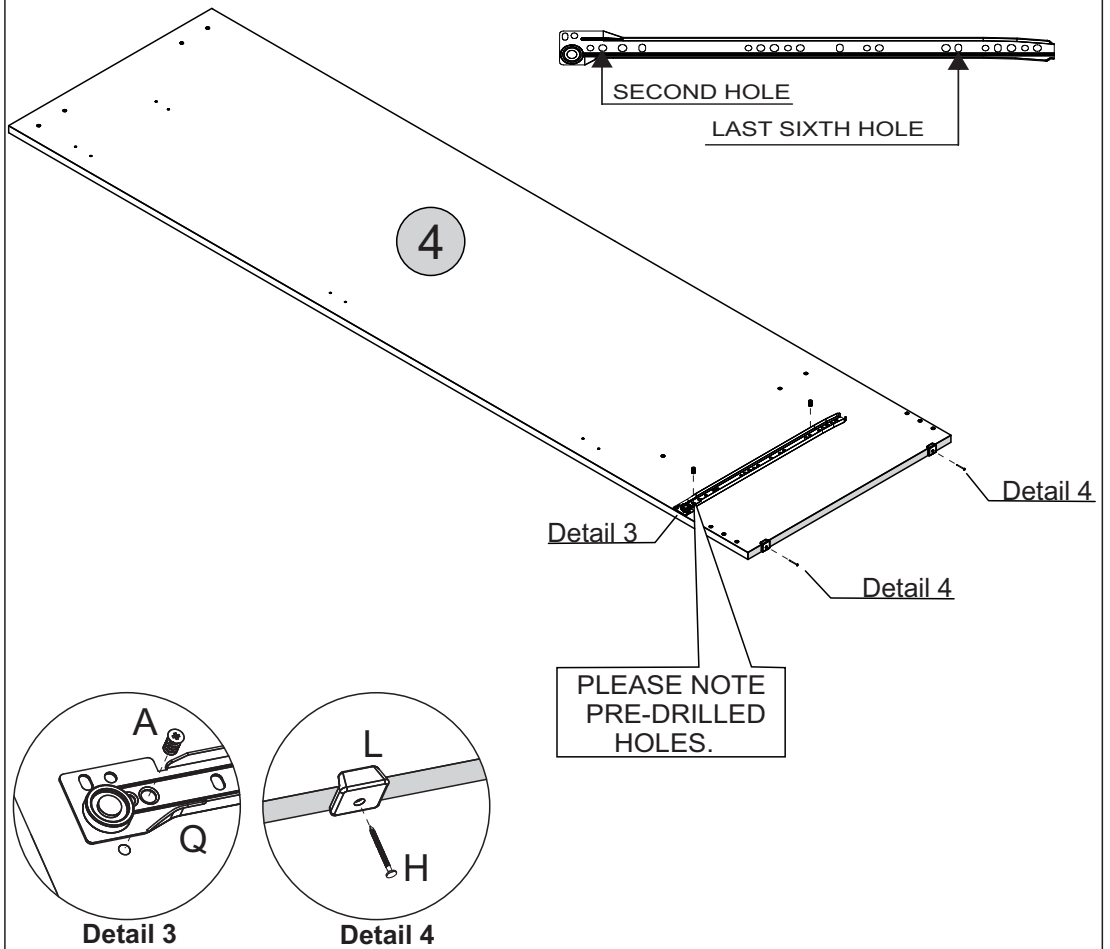
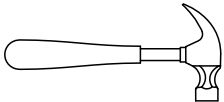
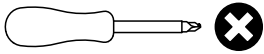



# STEP 2

## PARTS REQUIRED

5 - RIGHT SIDE PANEL x1

## HARDWARE REQUIRED

A  02  
Ø6,0 x 10mm

H  02  
10 x 10

L  02

Q  01  
RIGHT

## TOOLS REQUIRED

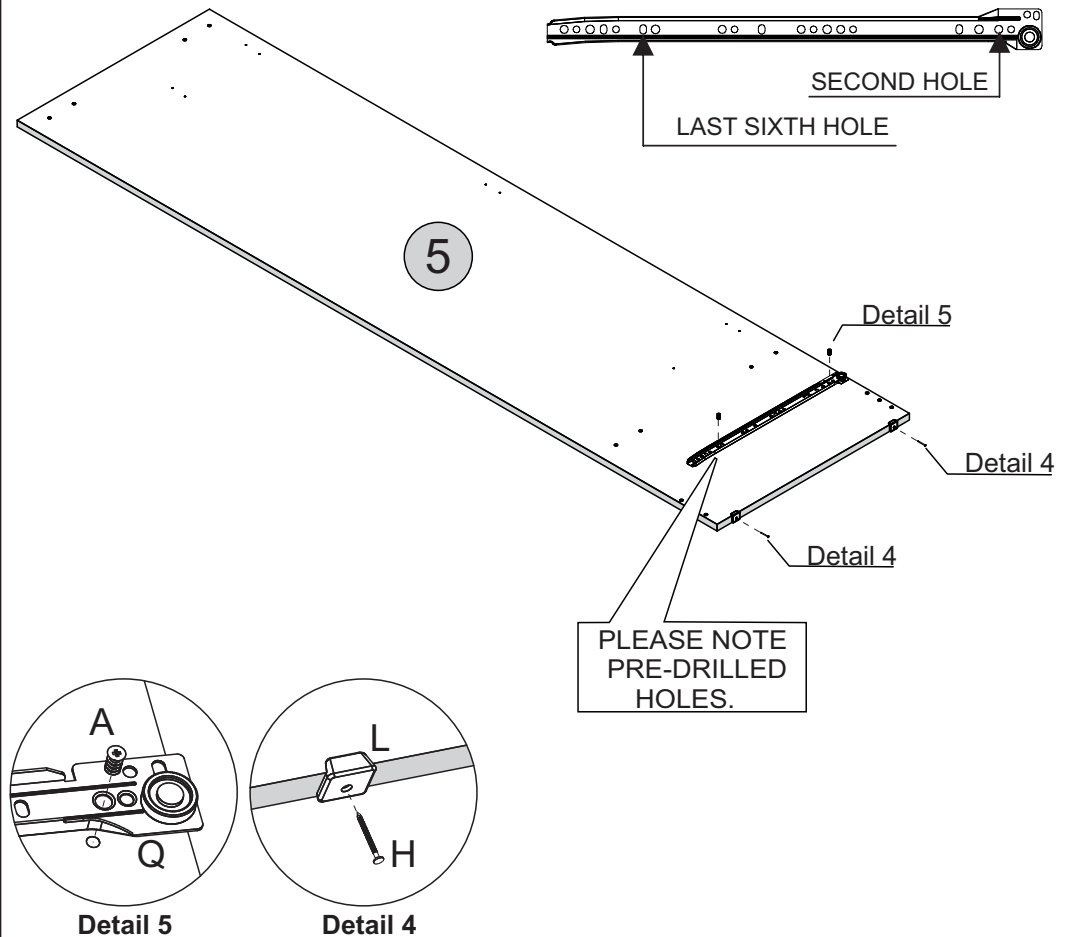
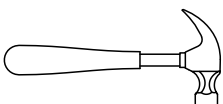
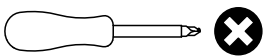

# STEP 3

## PARTS REQUIRED

4 - LEFT SIDE PANEL x1

## HARDWARE REQUIRED

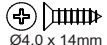
C  08  
Ø4,0 x 14mm

M  01

P  03

## TOOLS REQUIRED

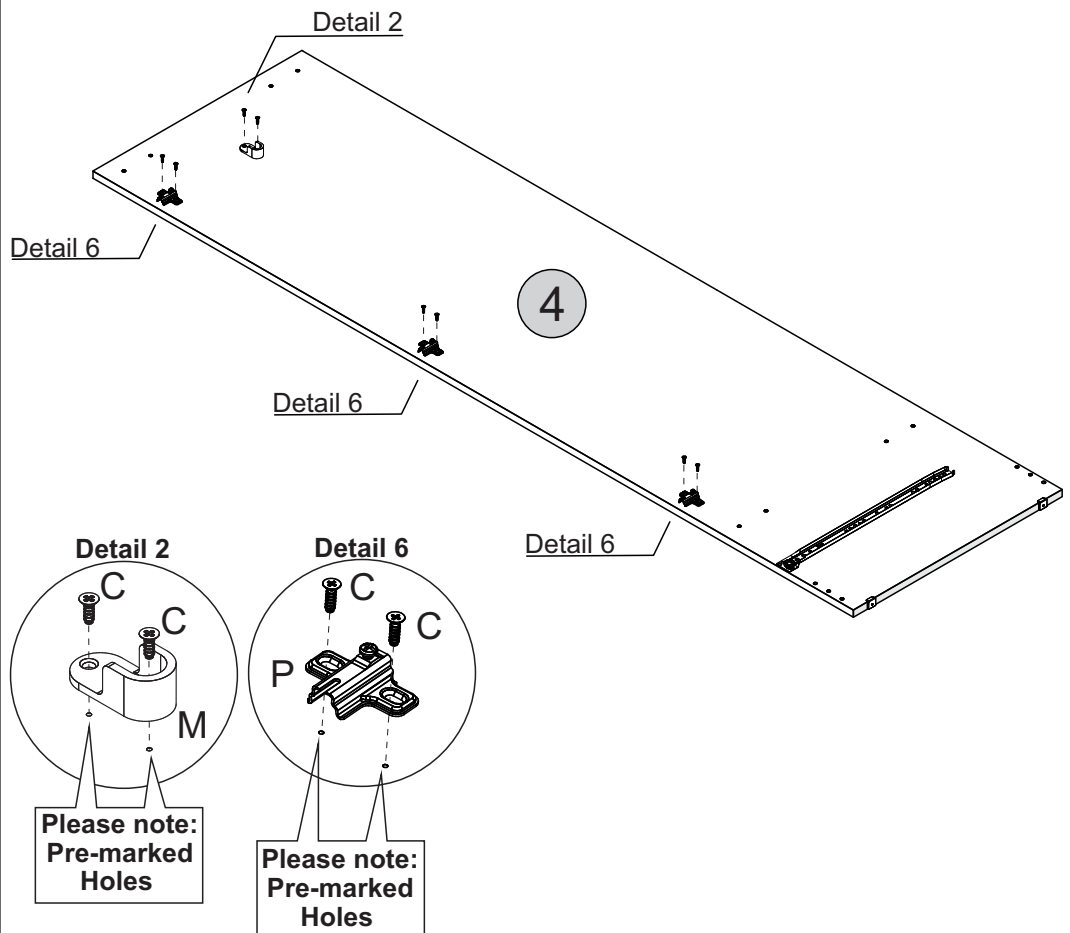
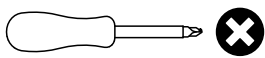



# STEP 4

## PARTS REQUIRED

5 - RIGHT SIDE PANEL x1

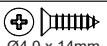
## HARDWARE REQUIRED

C  08  
Ø4,0 x 14mm

M  01

P  03

## TOOLS REQUIRED

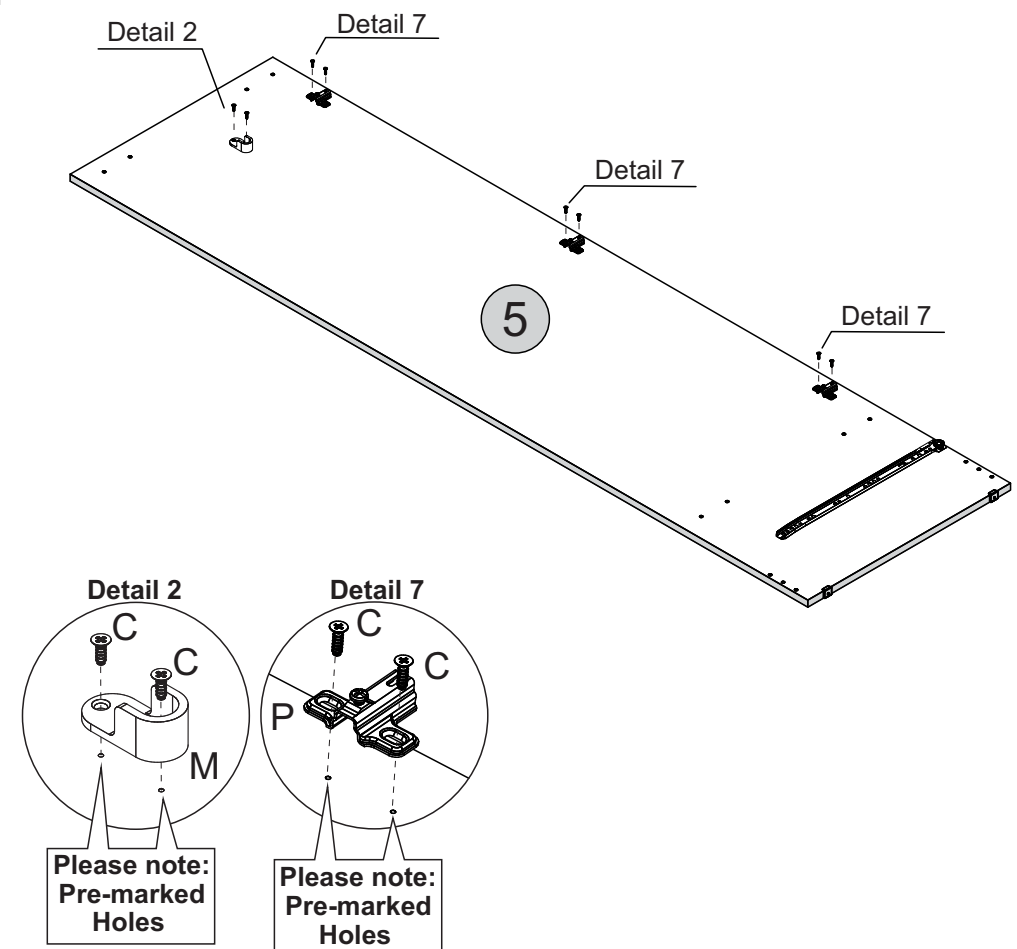
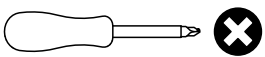

# STEP 5

## PARTS REQUIRED

1A - BASE PANEL x1

1B - TOP PANEL x1

## HARDWARE REQUIRED

G  08  
Ø6,0 x 30mm

J  02

V  01

Y  06  
Ø4,0 x 12mm

Z  02

## TOOLS REQUIRED

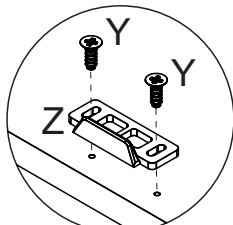
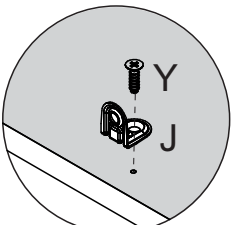
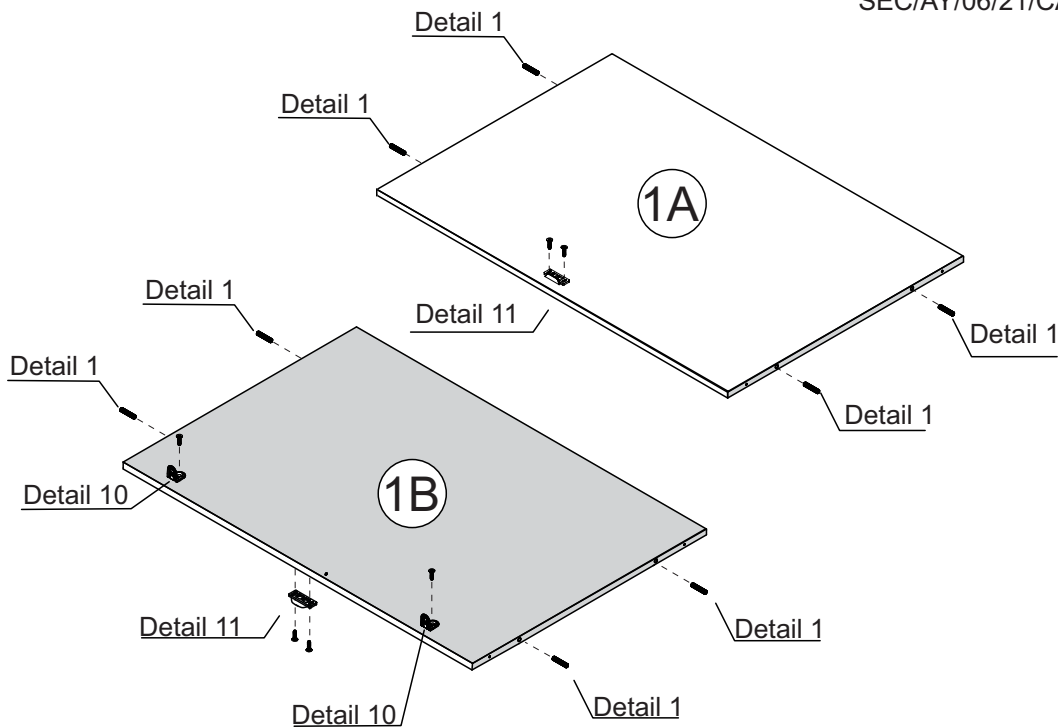
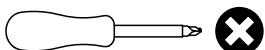

Detail 1

Detail 10

Detail 11

# STEP 6

## PARTS REQUIRED

2 - FRONT BASEBOARD x1

3 - BACK BASEBOARD x1

## HARDWARE REQUIRED

G  08  
Ø6,0 x 30mm

H  02  
10 x 10

L  02

V  01

## TOOLS REQUIRED

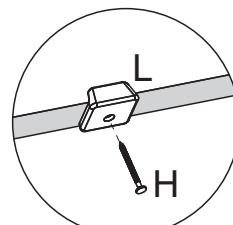
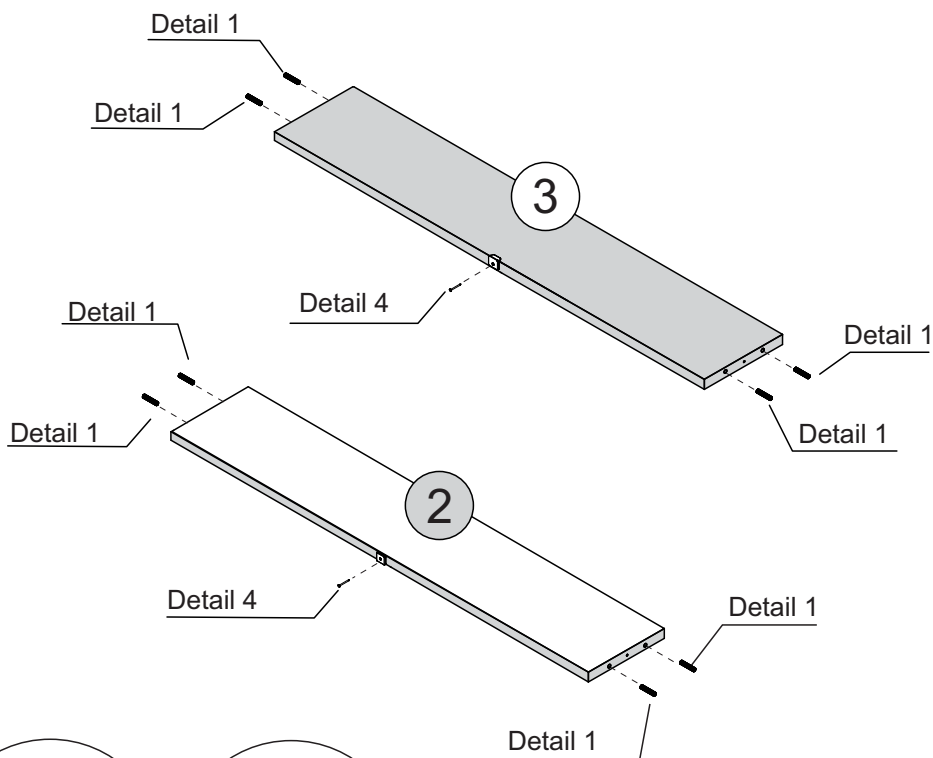
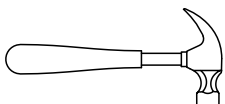

Detail 1



Detail 4

# STEP 7

## PARTS REQUIRED

- 1A - BASE PANEL x1
- 1B - TOP PANEL x1
- 5 - RIGHT SIDE PANEL x1

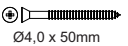
## HARDWARE REQUIRED

- F  04  
Ø4,0 x 50mm
- V  01

## TOOLS REQUIRED

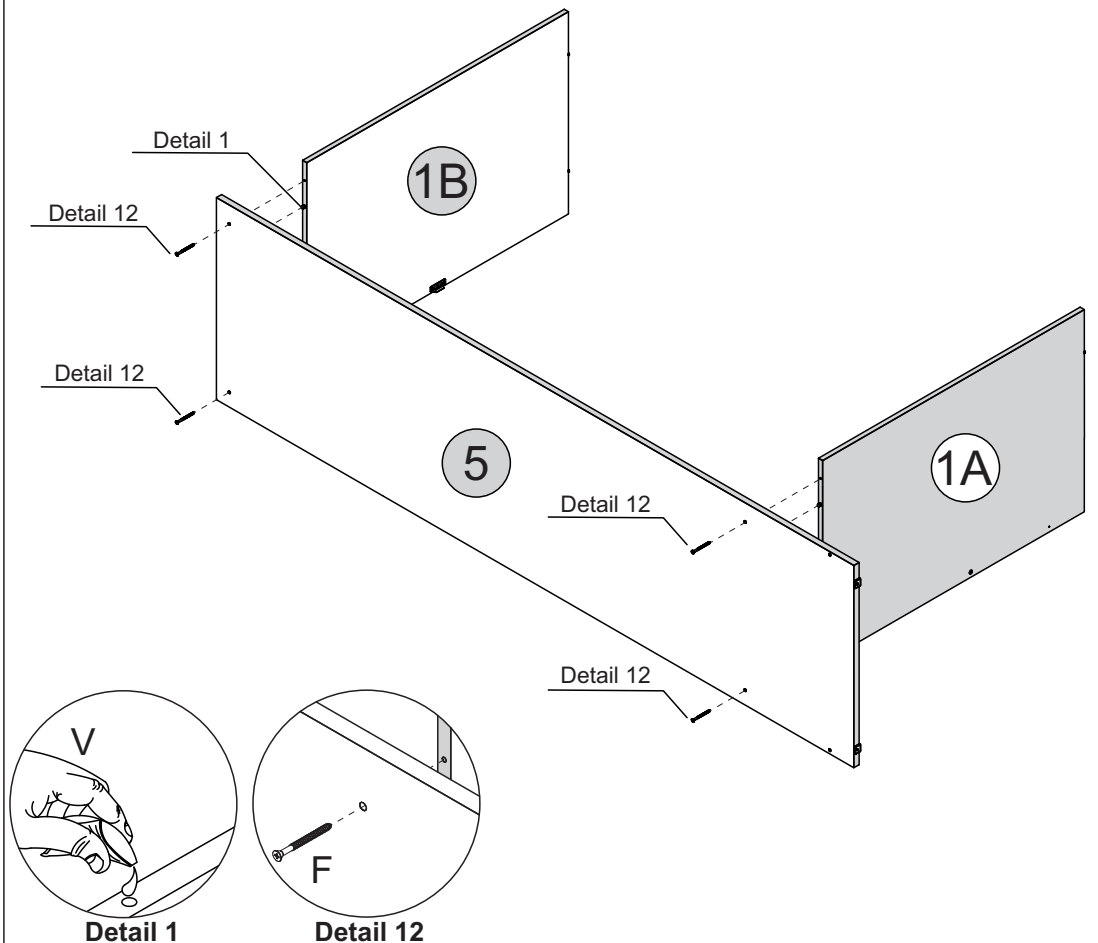
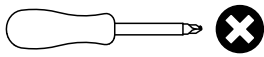



# STEP 8

## PARTS REQUIRED

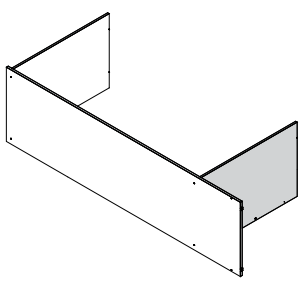
- 2 - FRONT BASEBOARD x1
- 3 - BACK BASEBOARD x1
- 4 - LEFT SIDE PANEL x1

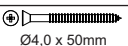

## HARDWARE REQUIRED

- F  08  
Ø4,0 x 50mm
- V  01

## TOOLS REQUIRED

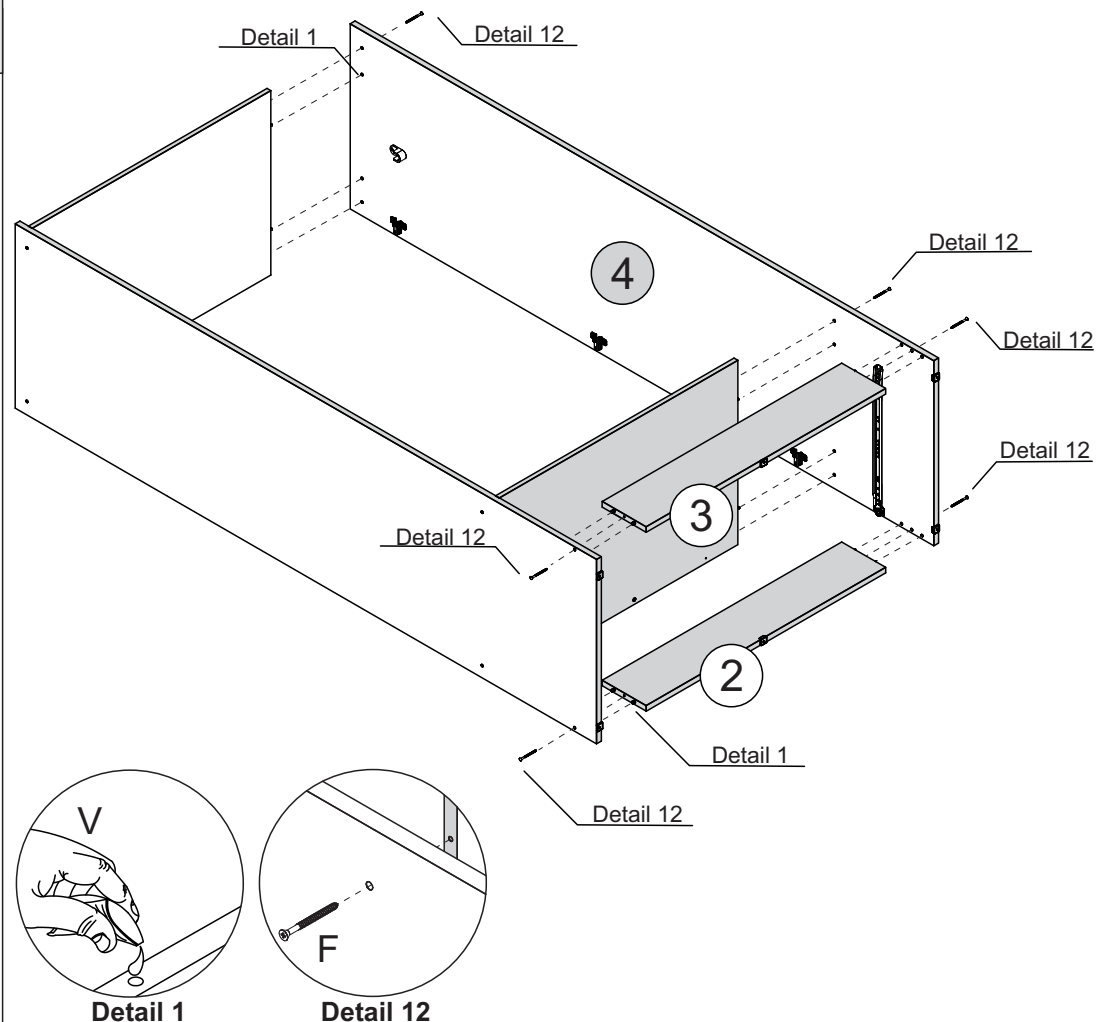
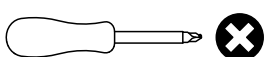

# STEP 9

### PARTS REQUIRED

6 - BACK PANEL x2

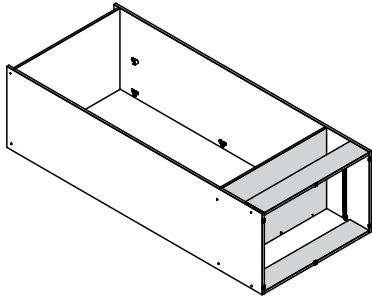

### HARDWARE REQUIRED

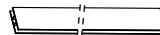
- H  40
- R  01

### TOOLS REQUIRED

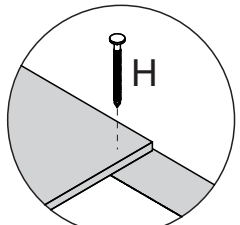
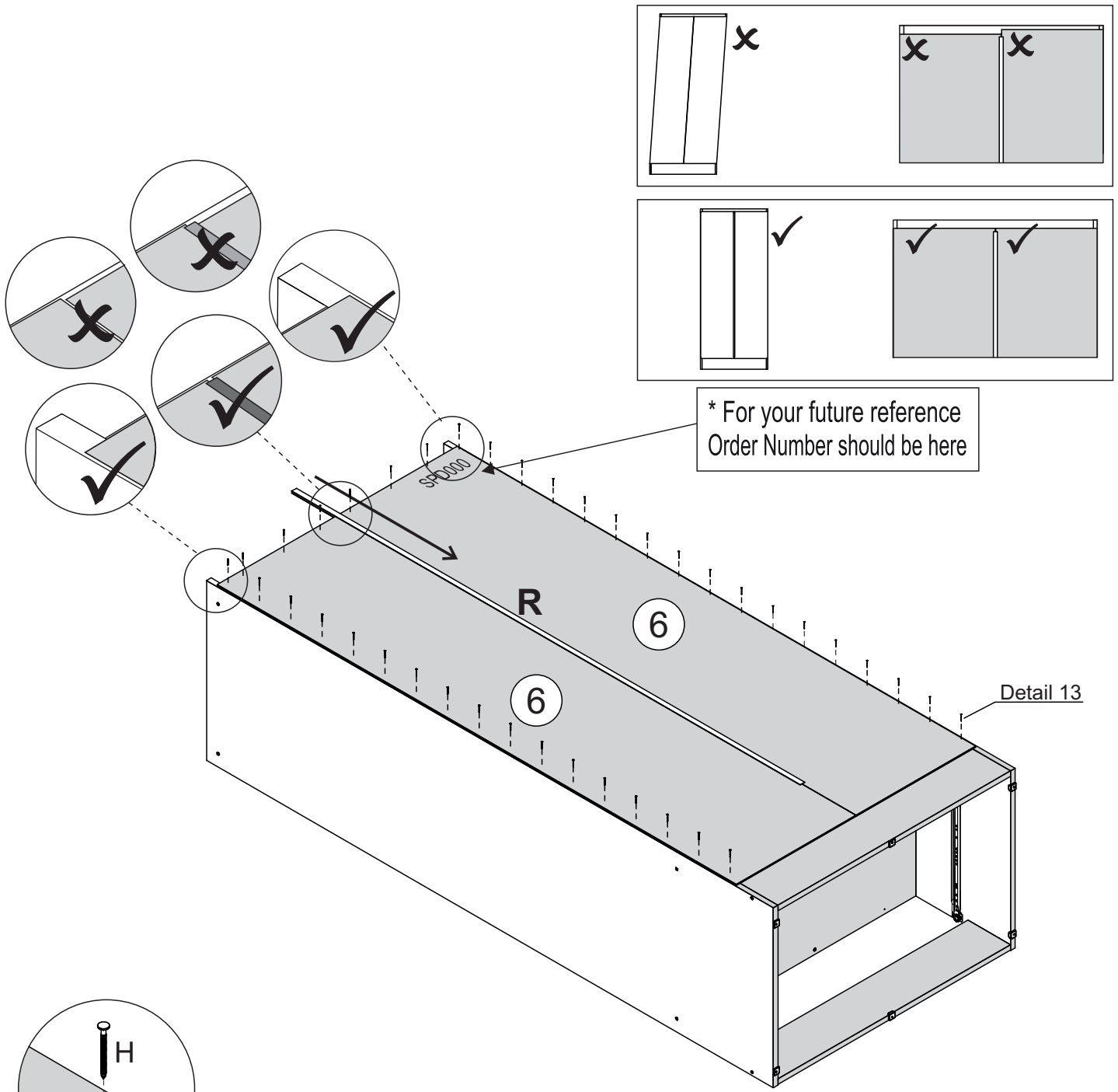
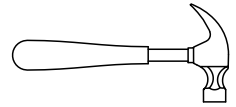

Detail 13



# STEP 10

SEC/AY/06/21/CA7

## PARTS REQUIRED

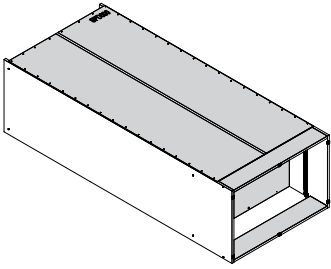

## HARDWARE REQUIRED

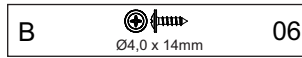
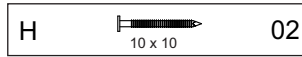

## TOOLS REQUIRED

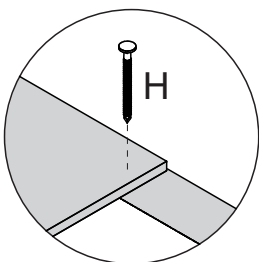
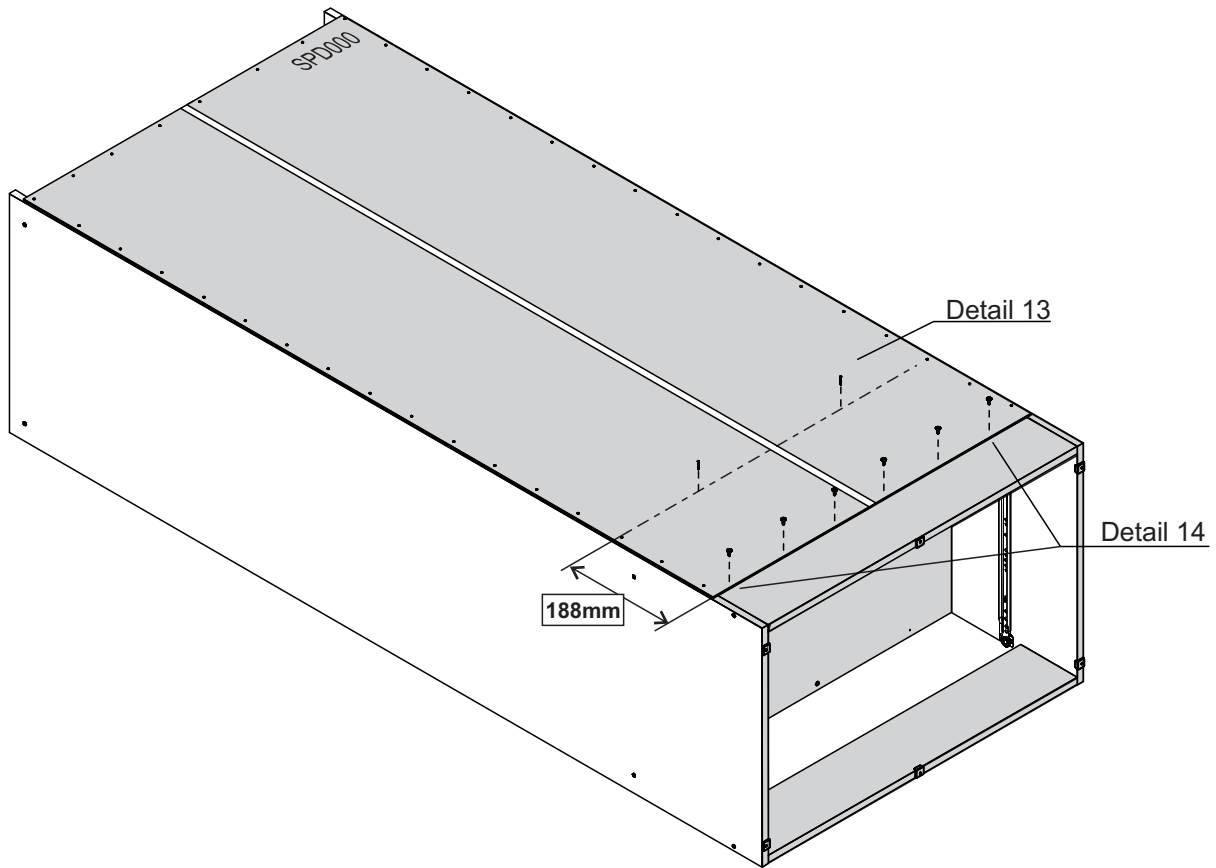
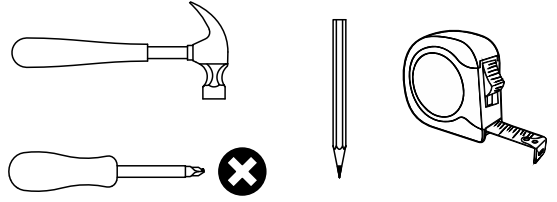

Detail 13

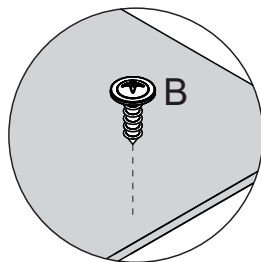

Detail 14

# STEP 11

## PARTS REQUIRED

7 - FRAME x1

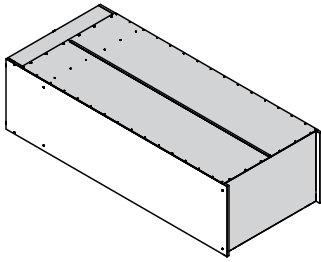

## HARDWARE REQUIRED

J  02

Y  06  
Ø4,0 x 12mm

## TOOLS REQUIRED

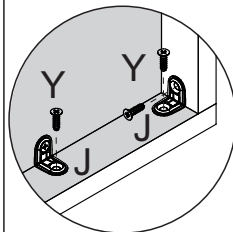
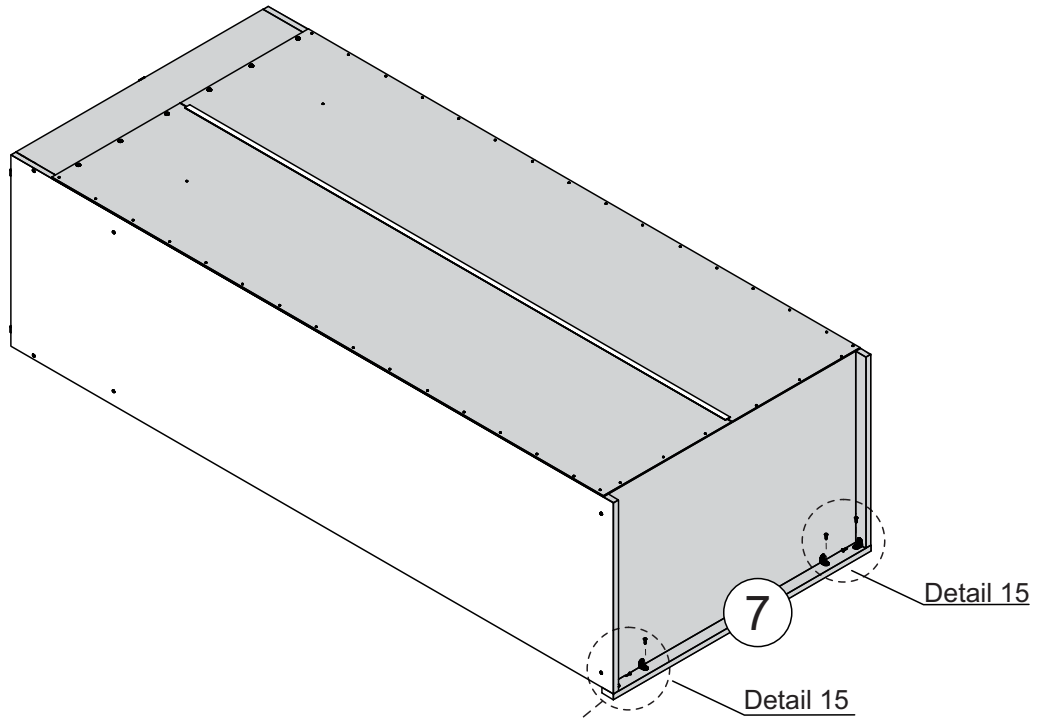
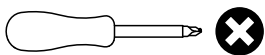

Detail 15

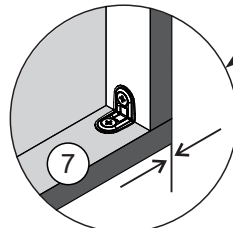

Align corners

# STEP 12

## PARTS REQUIRED

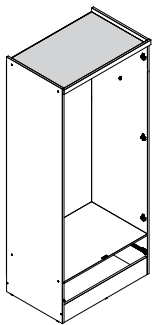

## HARDWARE REQUIRED

N  01

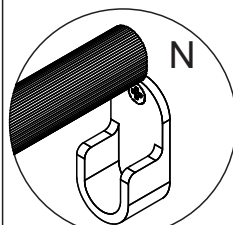
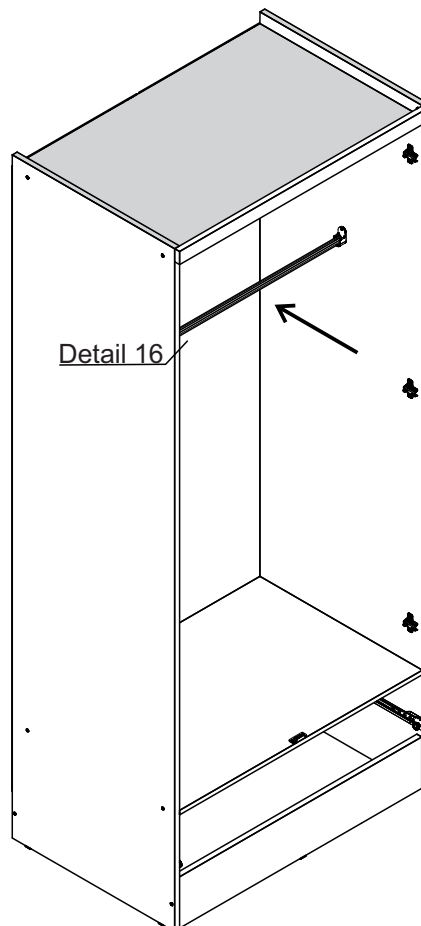

Detail 16

# STEP 13

## PARTS REQUIRED

10 - DRAWER SIDE x2

11 - DRAWER BACK PANEL x1

14 - DRAWER BOTTOM SUPPORT BAR x1

## HARDWARE REQUIRED

G  Ø6,0 x 30mm 10

V  Glue 01



Detail 1

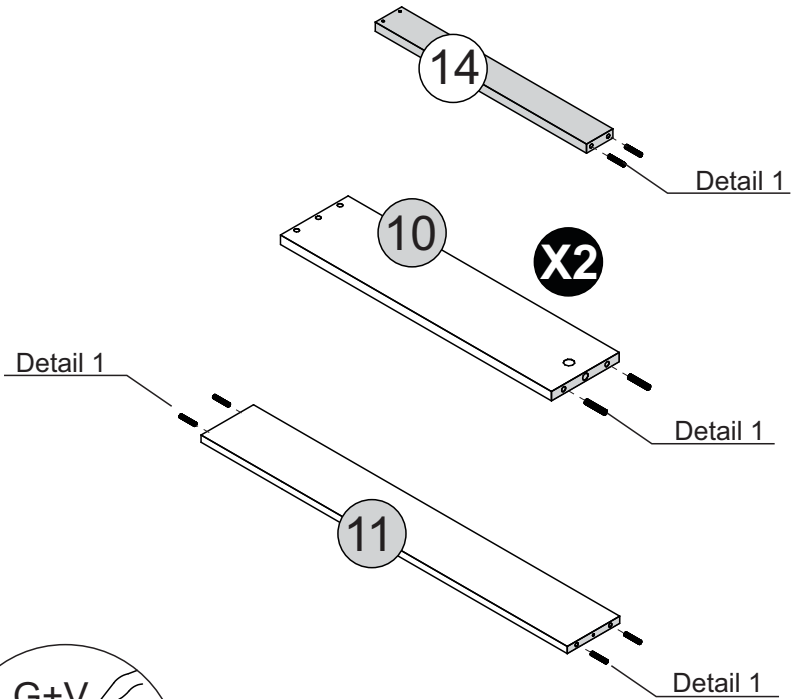

# STEP 14

## PARTS REQUIRED

12 - DRAWER FRONT x1

## HARDWARE REQUIRED

X  02

## TOOLS REQUIRED

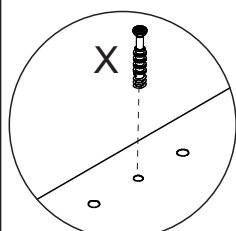
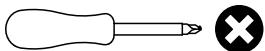

Detail 9

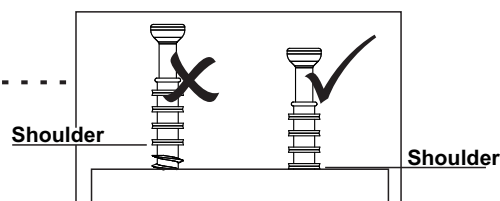
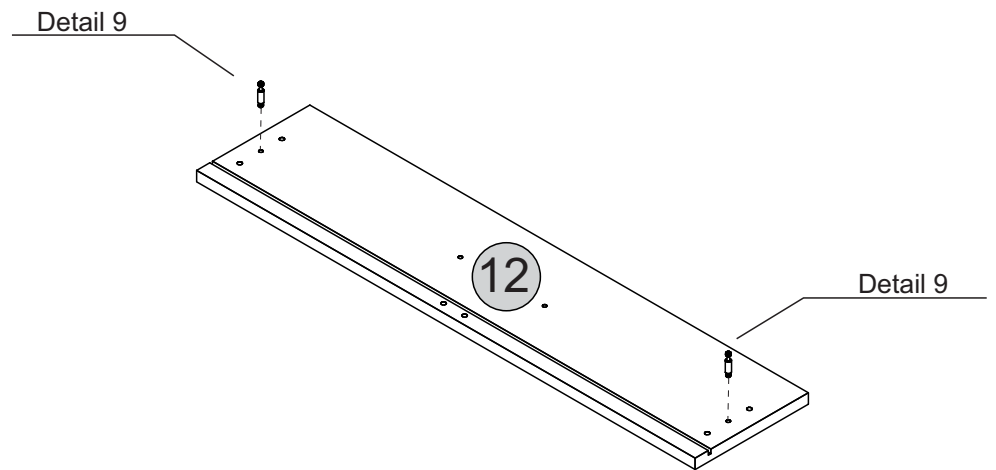

# STEP 15

## PARTS REQUIRED

10 - DRAWER SIDE x2

11 - DRAWER BACK PANEL x1

## HARDWARE REQUIRED

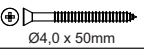
F  02  
Ø4,0 x 50mm

## TOOLS REQUIRED

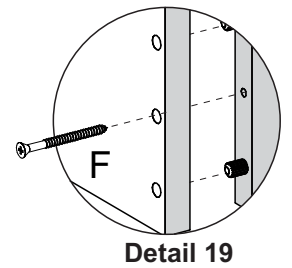
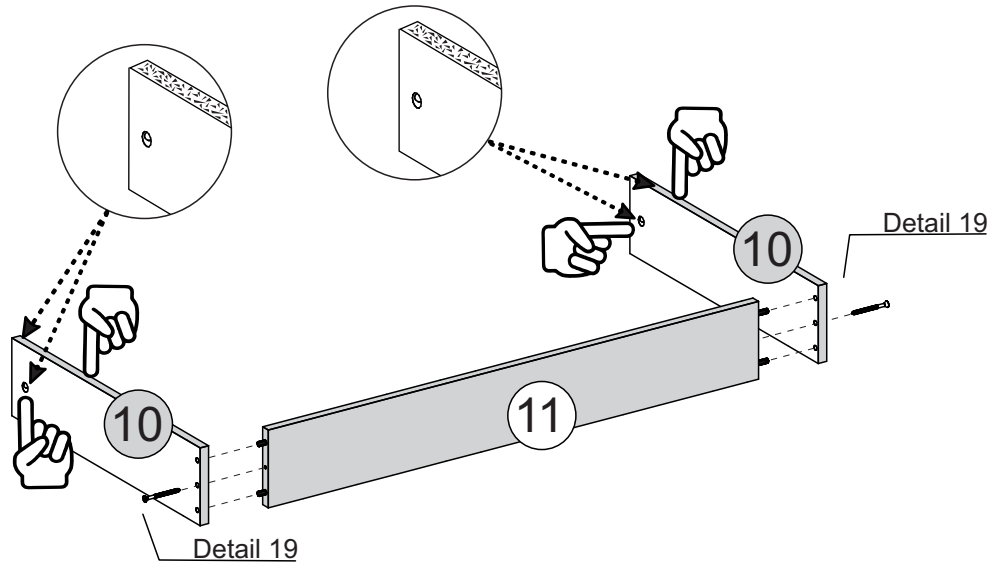
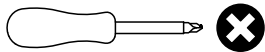

# STEP 16

## PARTS REQUIRED

12 - DRAWER FRONT x1

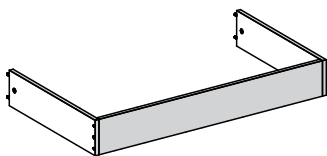

## HARDWARE REQUIRED

A1  02

V  01

W  02

## TOOLS REQUIRED

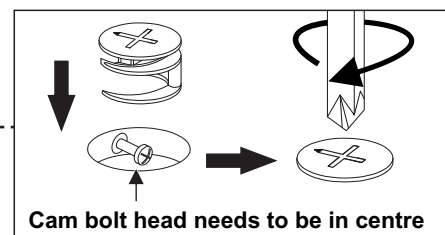
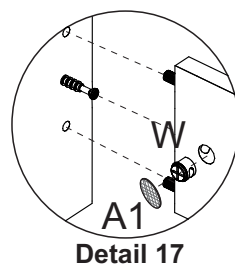
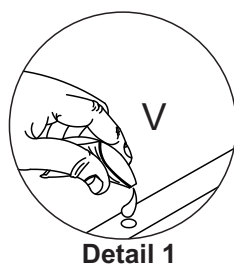
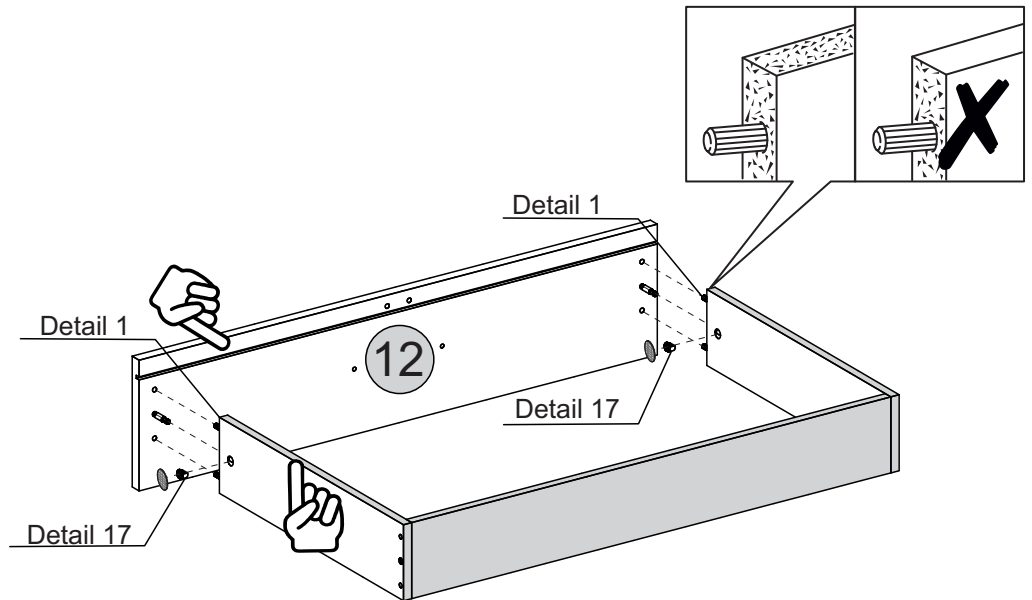
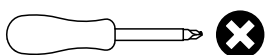

# STEP 17

## PARTS REQUIRED

13 - DRAWER BOTTOM x1

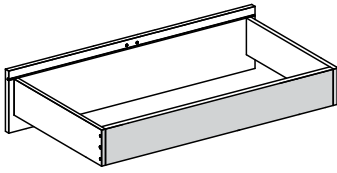

## HARDWARE REQUIRED

H  04  
10 x 10

## TOOLS REQUIRED

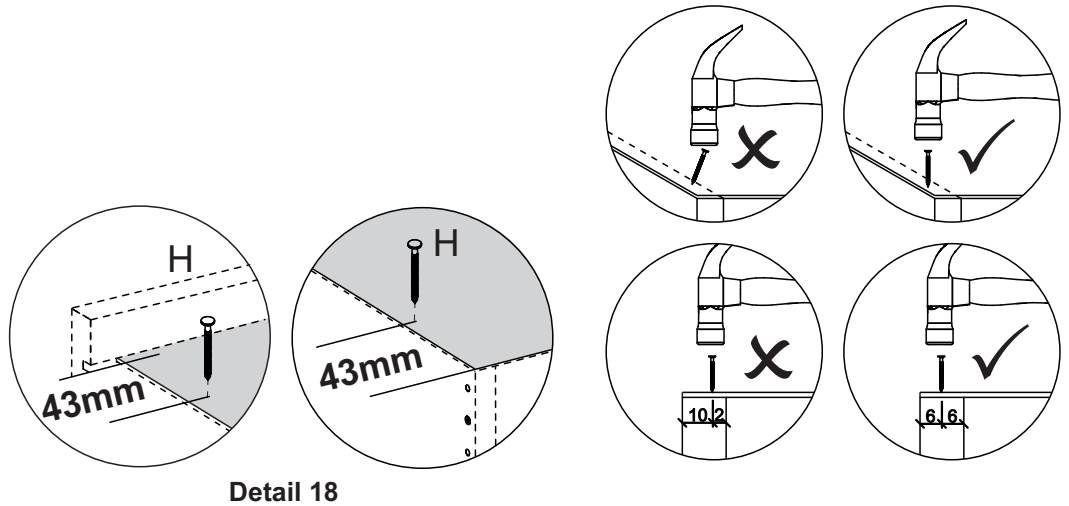
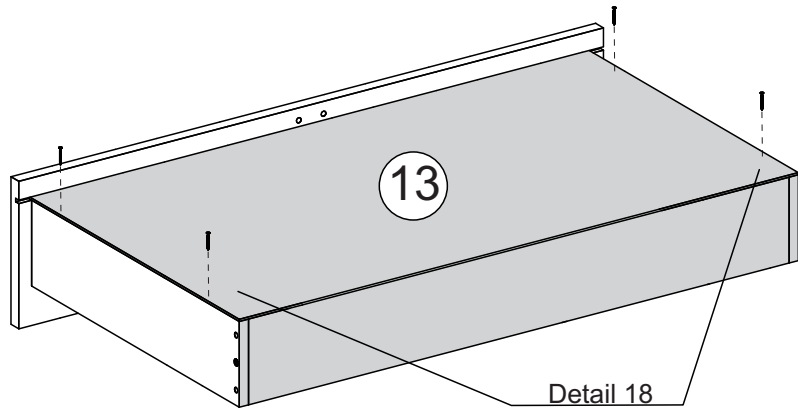
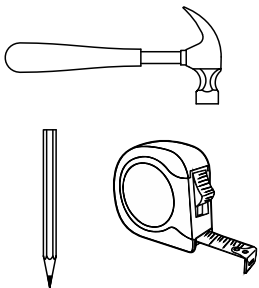

# STEP 18

## PARTS REQUIRED

14 - DRAWER BOTTOM SUPPORT BAR x1

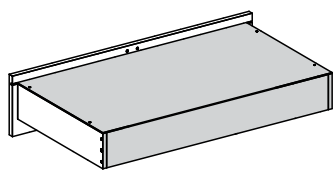

## HARDWARE REQUIRED

H  06  
10 x 10

## TOOLS REQUIRED

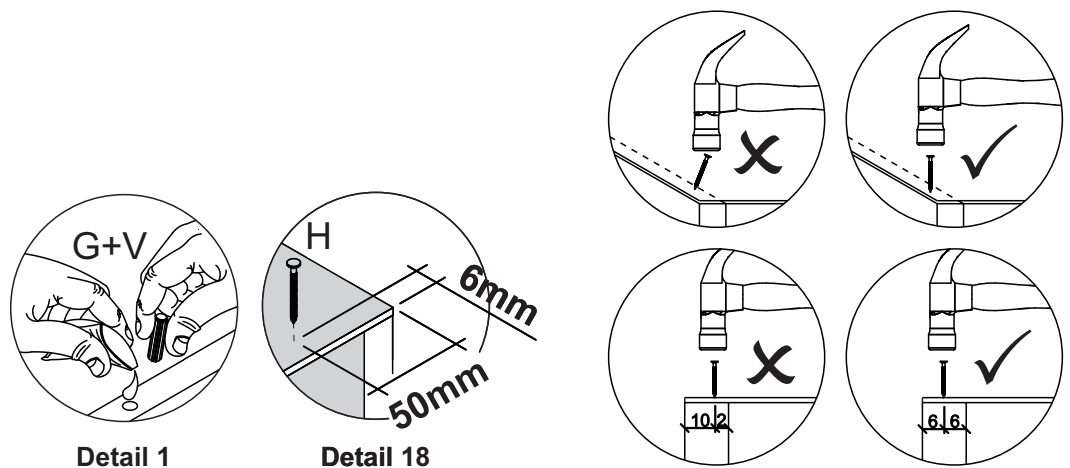
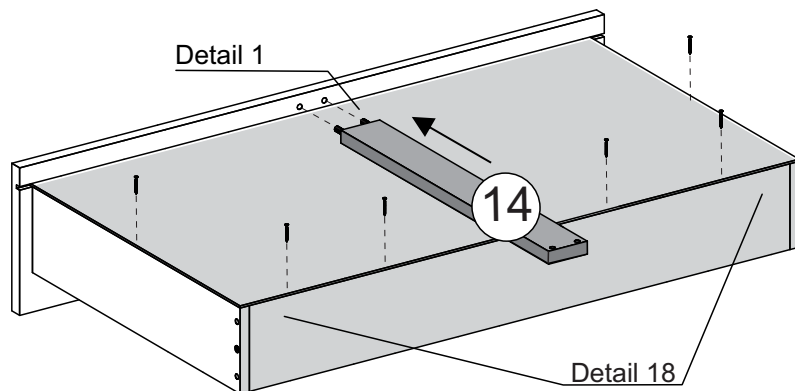
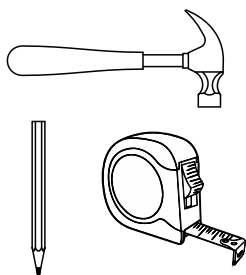

# STEP 19

## PARTS REQUIRED

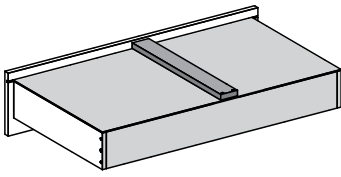

## HARDWARE REQUIRED

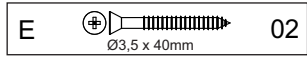
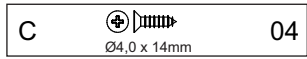

## TOOLS REQUIRED

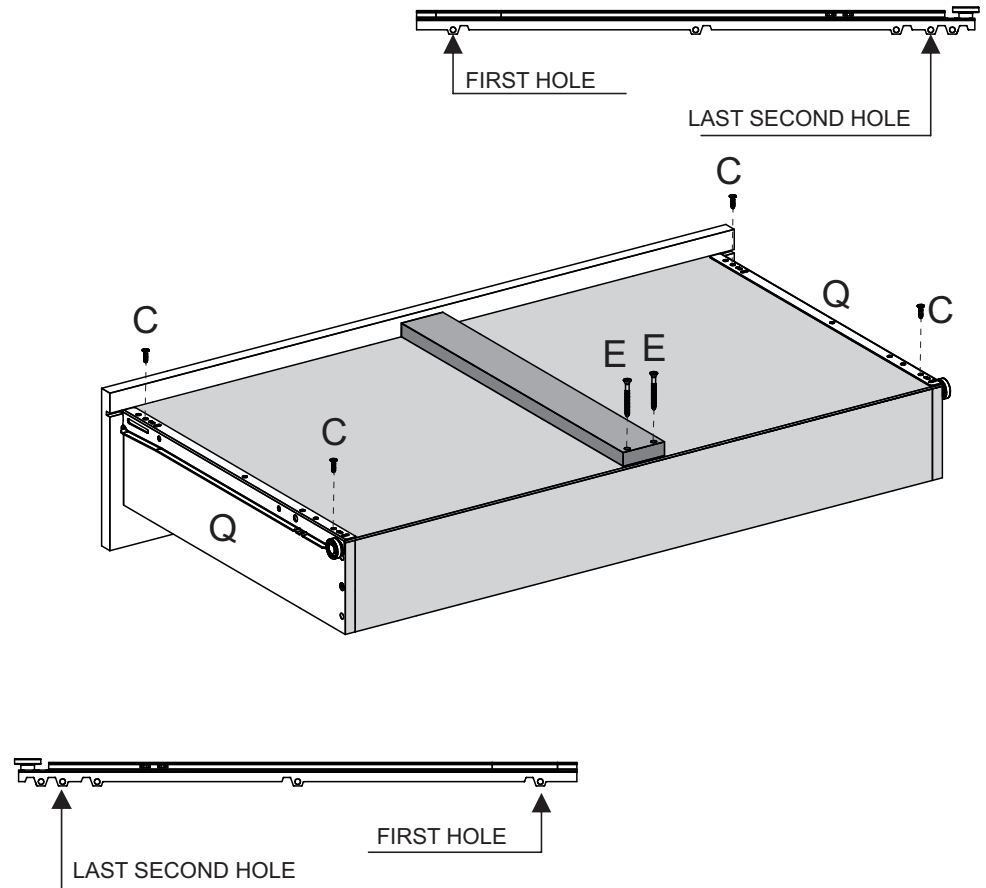
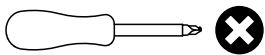

# STEP 20

## PARTS REQUIRED

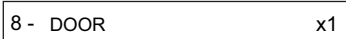

## HARDWARE REQUIRED

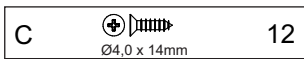

## TOOLS REQUIRED

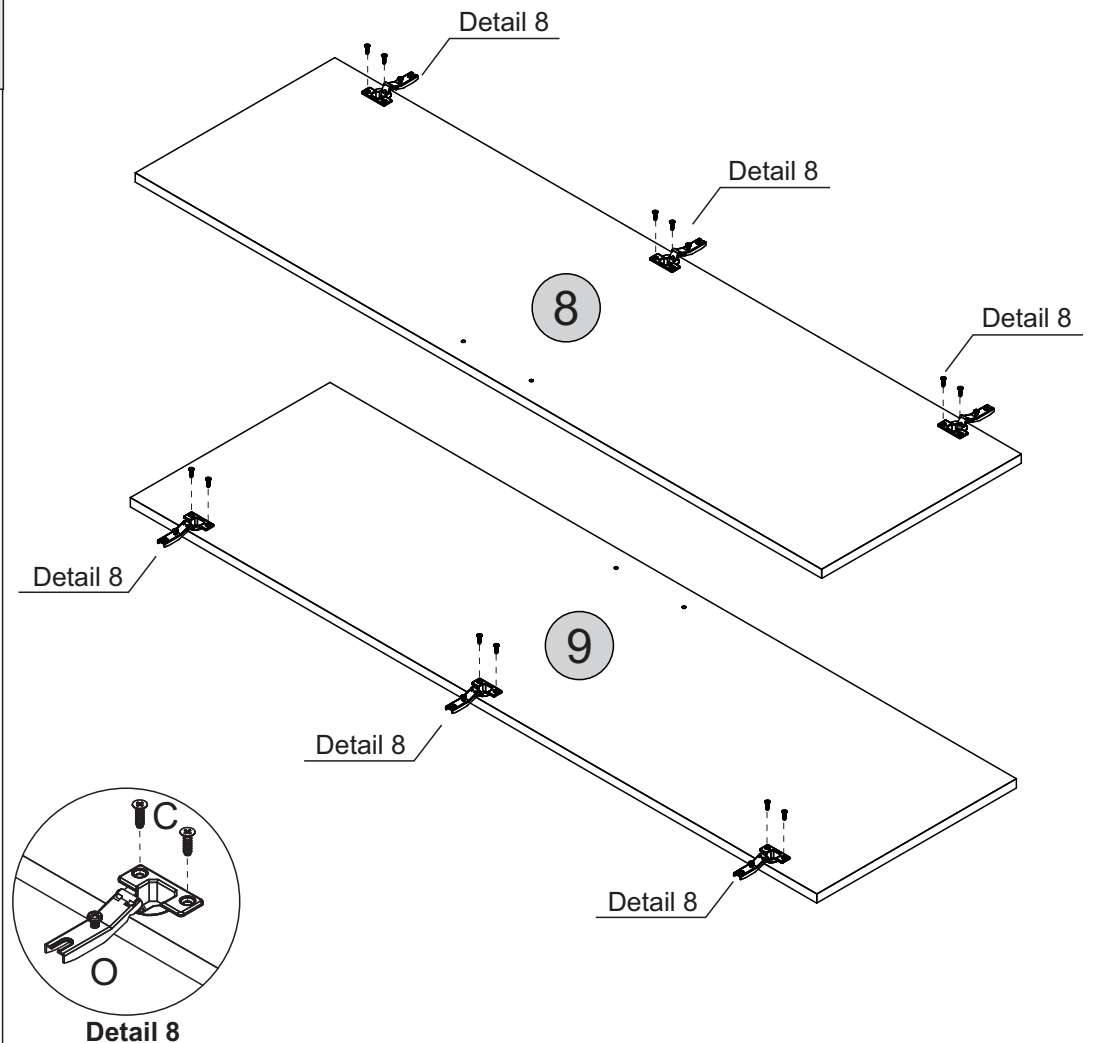
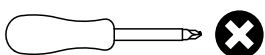

# STEP 21

## PARTS REQUIRED

8 - DOOR x1

9 - MIRRORED DOOR x1

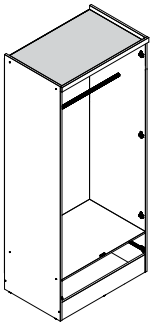

## HARDWARE REQUIRED

U  12

## TOOLS REQUIRED

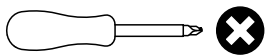

**!**  
Please note the top or bottom edges of the doors are labelled LEFT or RIGHT to make them easier to identify when assembling.

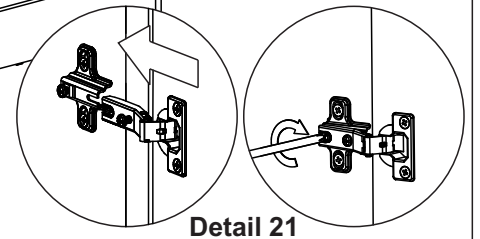
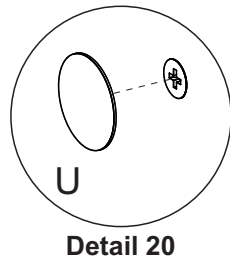
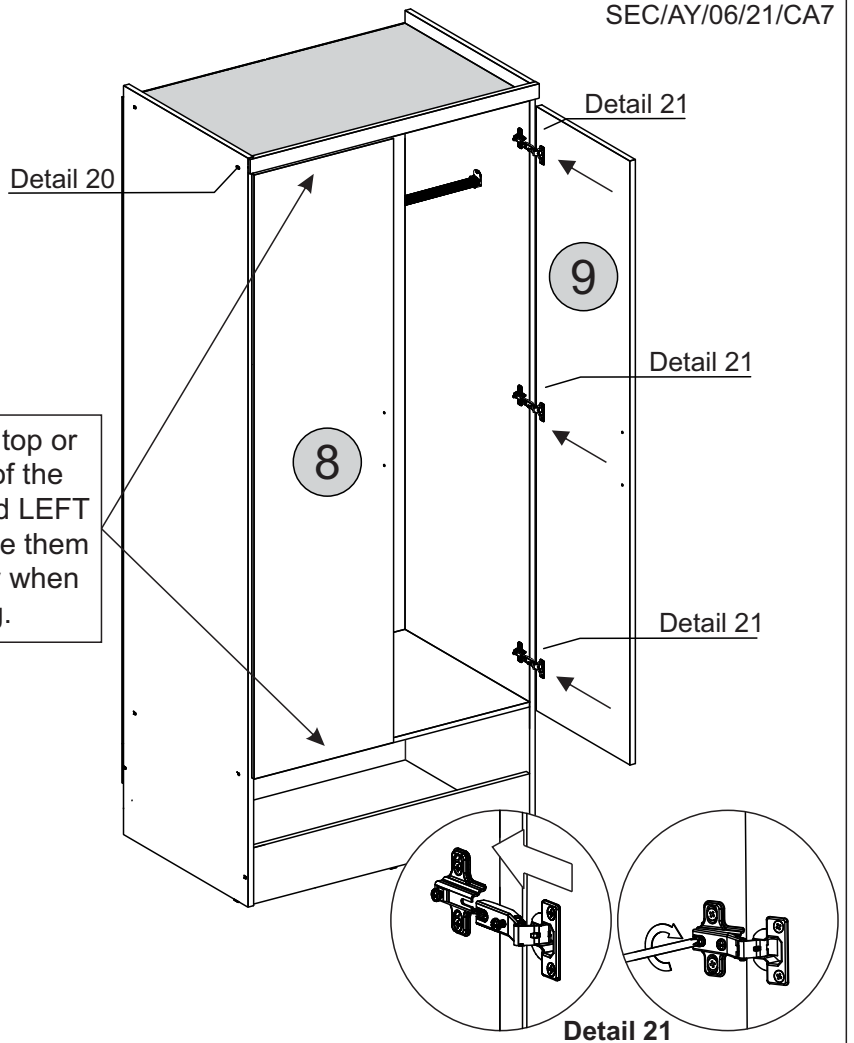

# STEP 22

## PARTS REQUIRED

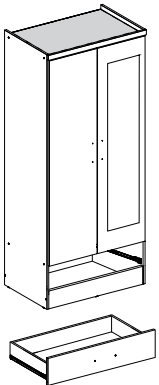

## HARDWARE REQUIRED

D  Ø4,0 x 20mm 06

T  03

## TOOLS REQUIRED

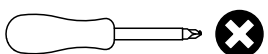

**!**  
See the last page

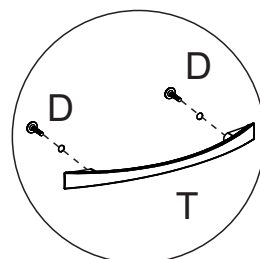
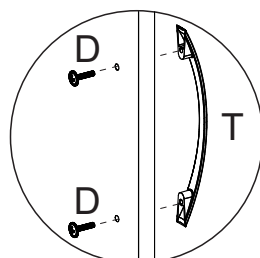

Detail 22

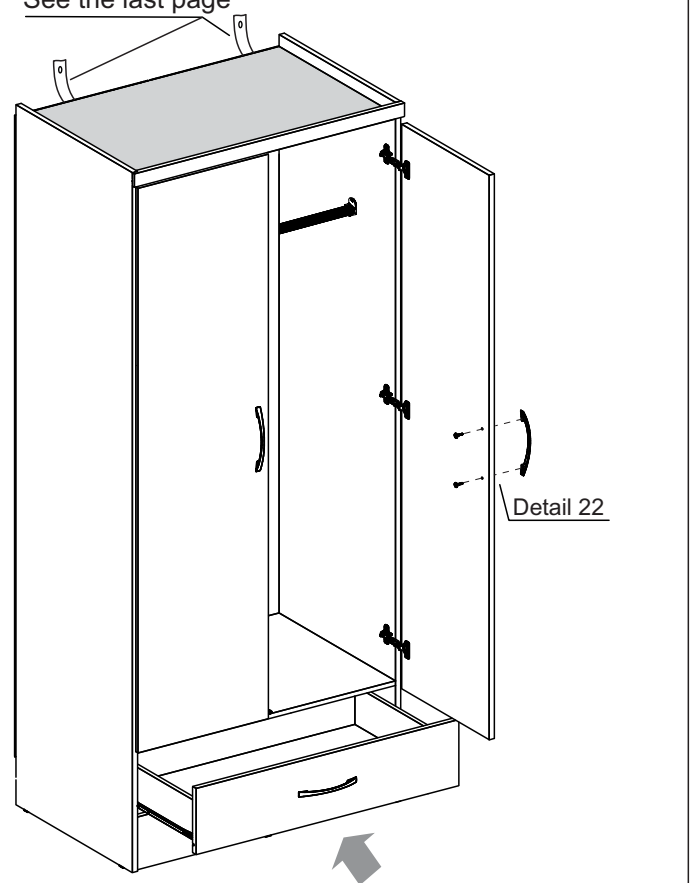

# STEP 23

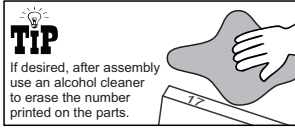

**PARTS REQUIRED**

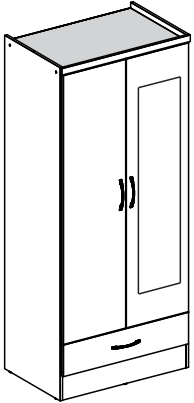

**HARDWARE REQUIRED**

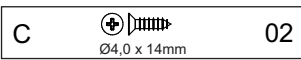

**TOOLS REQUIRED**

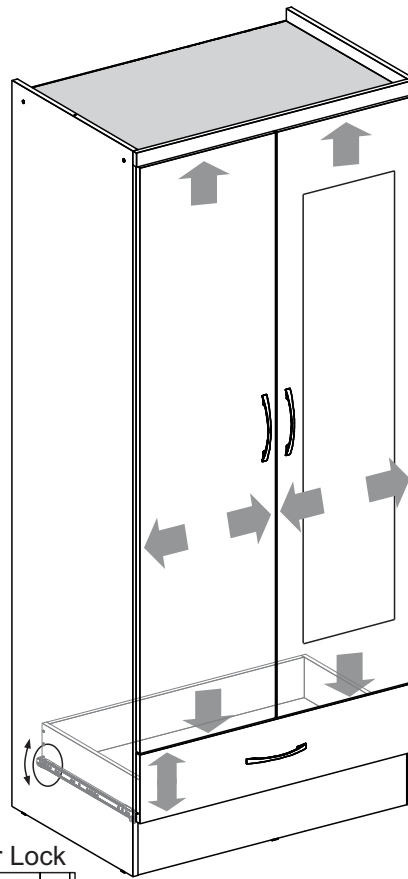
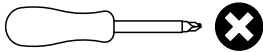

**Height Adjustment**

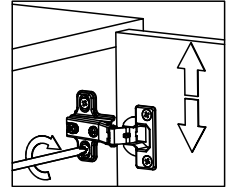

**Internal Adjustment**

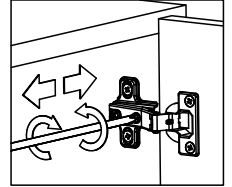

**Depth Adjustment**

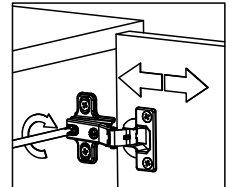
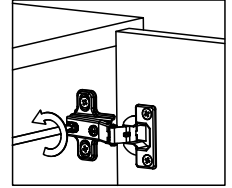

**Drawer Adjustment    Drawer Lock**

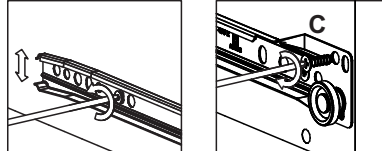

Detail 23

## WARNING

**Serious or fatal injuries can occur from furniture tipping over. To prevent the furniture from tipping over we recommend that it is permanently fixed to the wall.**

Wall fixings are not supplied with this product as different wall materials require different types of fixing devices.

Please make sure you use fixings suitable for the walls in your home.

